

PICTURE/DIRECT SET WINDOW/WALL CONNECTION DETAILS

HEAD & SILL DETAILS

3" = 1'-0"

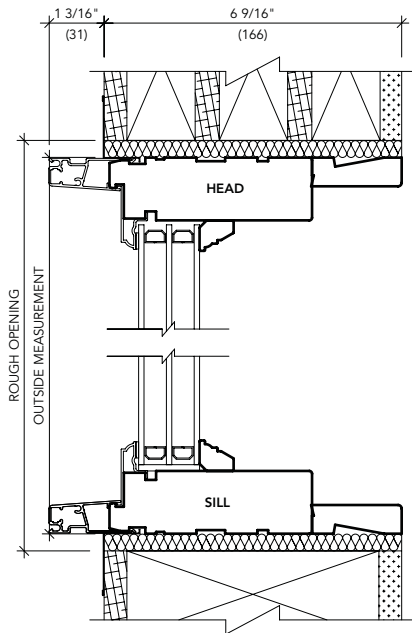

METAL CLAD TRIPLE 6 9/16" (166 mm)

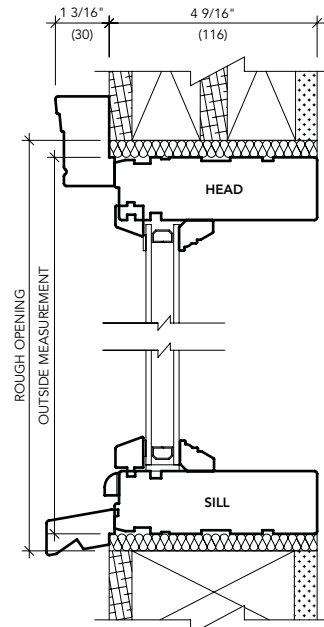

WOOD DOUBLE 4 9/16" (116 mm)

PLAN VIEW – METAL CLAD & WOOD

3" = 1'-0"

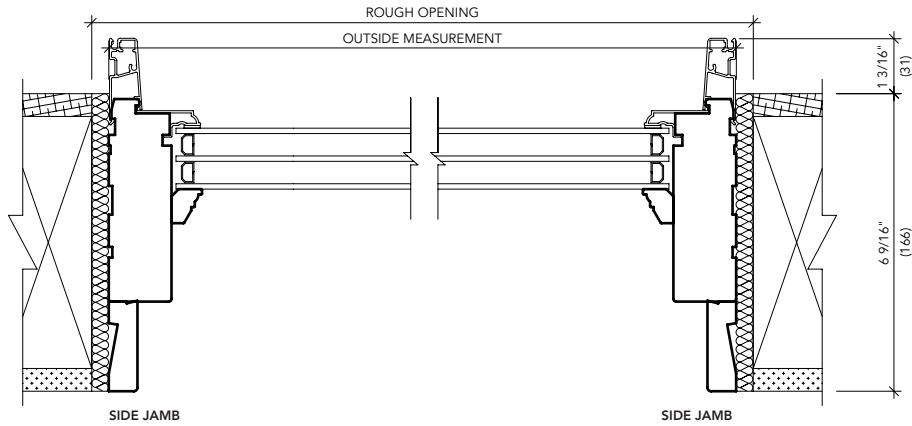

METAL CLAD TRIPLE 6 9/16" (166 mm)

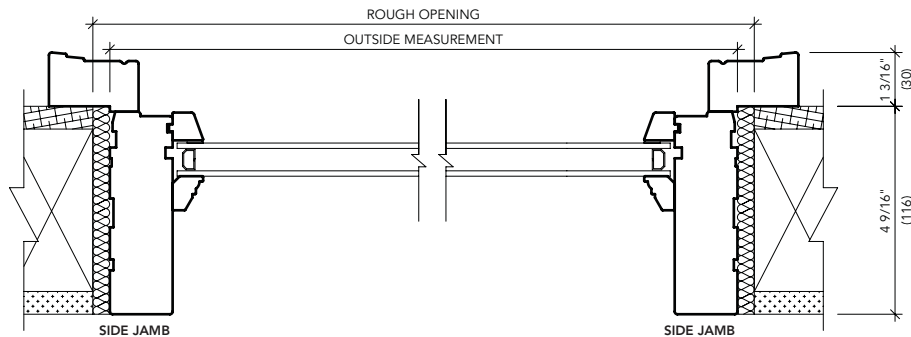

WOOD DOUBLE 4 9/16" (116 mm)

Note: • Other jamb widths available.  
• All dimensions to have a +/- 1/16" (2 mm) tolerance.

PICTURE/DIRECT SET WINDOW DETAILS

HEAD & SILL DETAILS

3" = 1'-0"

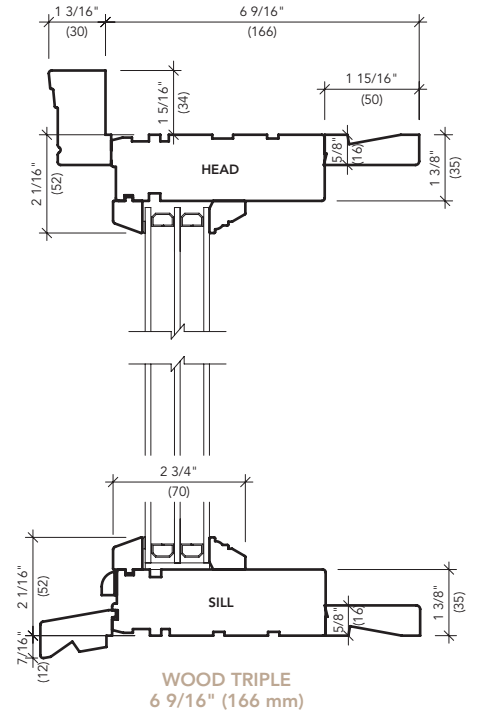
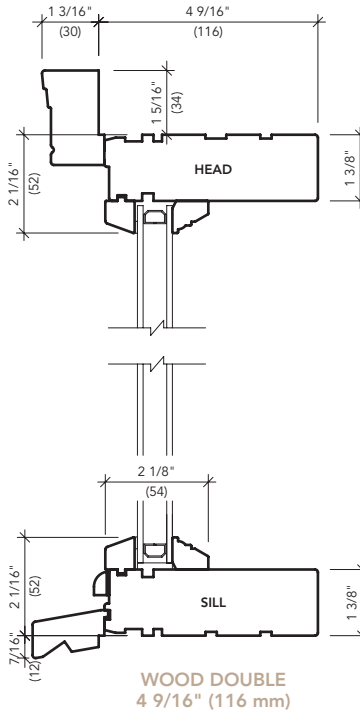
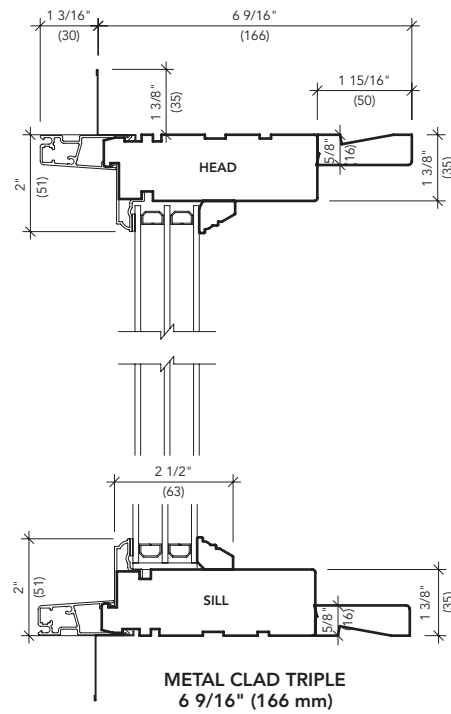

PLAN VIEW

3" = 1'-0"

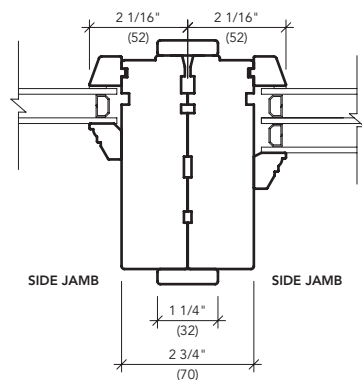
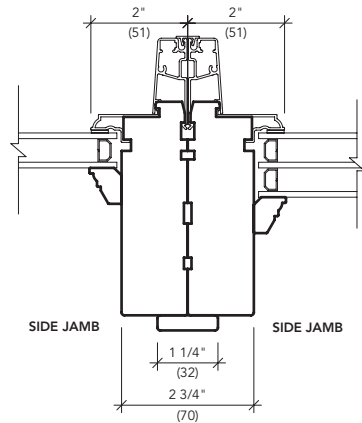

Not to Scale

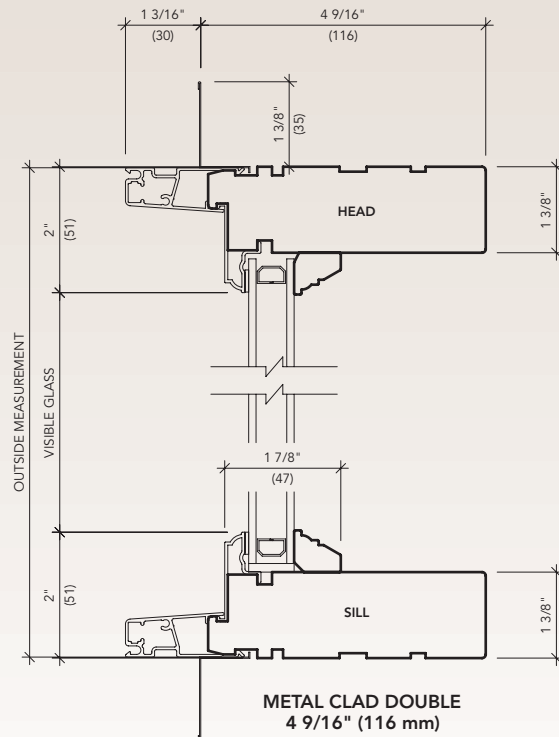

Note: • Other jamb widths available.  
• All dimensions to have a +/- 1/16" (2 mm) tolerance.

