



TECHNICAL GUIDE H
SPECIALTY WINDOWS

PRODUCT FEATURES

STYLES

Picture, Fixed Casement, Operating Casement, Single Hung, Double Hung, Terrace and French door.

STANDARD FEATURES

- Natural Douglas Fir interior (no visible finger joints)
- 4 9/16" (116 mm) jamb construction
- Clear Low E insulated glazing with 1/2" (13 mm) airspace
- Extruded aluminum cladding in a variety of standard colors, primed wood or clear fir exterior
- Flexible weatherstrip system
- Insect screens with high transparency mesh option

HARDWARE

Multiple hardware type and finish choices are available. See the Hardware in section A for more information.

GLAZING

Heat-Smart® Double, Heat-Smart® Triple, Tranquility® and StormForce™. StormForce not available on all products.

SIMULATED DIVIDED LITES (SDL)

Ogee Profile — 3/4" (19 mm), 1 1/8" (30 mm), 2" (51 mm).
Putty Profile — 5/8" (16 mm), 7/8" (22 mm), 1 1/8" (30 mm), 2" (51 mm).

Square Profile (interior only) — 3/4" (19 mm), 7/8" (22 mm), 1 1/8" (30 mm), 2" (51 mm).

CASING

WOOD: 2" (51 mm) Brickmould, 3 1/2" (89 mm) Flat, 5 1/2" (139 mm) Flat, Adams and Williamsburg.

METAL CLAD: 2" (51 mm) Brickmould, 3 1/2" (89 mm) Flat, Nose & Cove, Adams, Williamsburg and Contemporary.

METAL CLAD COLOR SPECTRUM

Standard and Architectural Palette colors, including anodized finishes.

SPECIFICATIONS

FRAME & SASH

Manufactured from Coastal Douglas Fir kiln-dried lumber with frame construction designed for 4 9/16" (116 mm) jamb. Shapes are manufactured from Fir wood strips, laminated to form a rigid wood frame. All wood exterior components are factory primed unless specified as clear exterior. Minor scratches or abrasions in the wood surface or primer are not considered defects.

ALTERNATE SPECIES

The entire Loewen product line is also available in optional Mahogany or optional FSC® chain of custody certified Douglas Fir (SCS-COC-005141).

INTERIOR CASING (RADIUS SHAPES ONLY)

A unique manufacturing technique utilizes continuous wood strips, laminated to form a one-piece casing which can be painted or stained to match other wood finishes.

PRESERVATIVE TREATED

All wood parts are dipped in approved preservative.

GLAZING

With countless glazing configurations and Low E coating options, we ensure that you can choose the perfect blend of protection and comfort.

INSULATING GLASS

Double or triple glass configurations with 1/2" (13 mm) airspace.

HEAT-SMART® SYSTEMS

Heat-Smart® best describes the benefits of the product that incorporates Low E coating and argon gas. Heat-Smart® systems help reduce heating and cooling costs, providing superior energy efficiency.

SIMULATED DIVIDED LITES (SDL)

Standard SDL complete with airspace grille. Grille bars are permanently applied to the interior and exterior.

DECORATIVE GLAZING DESIGNS

All products in this catalog are available with decorative glass designs which include etched glass, textured, beveled glass and much more.

METAL CLADDING

Heavy duty exterior metal cladding comprised of extruded aluminum is available in a variety of Standard and Architectural Palette colors, including anodized and Cyprium (copper and bronze cladding). Interior of window can be natural wood (unfinished) or primed. Metal clad units are supplied ready-to-install complete with integral metal nailing flange.

H2

www.loewen.com | 1.800.563.9367 | SPECIALTY WINDOWS

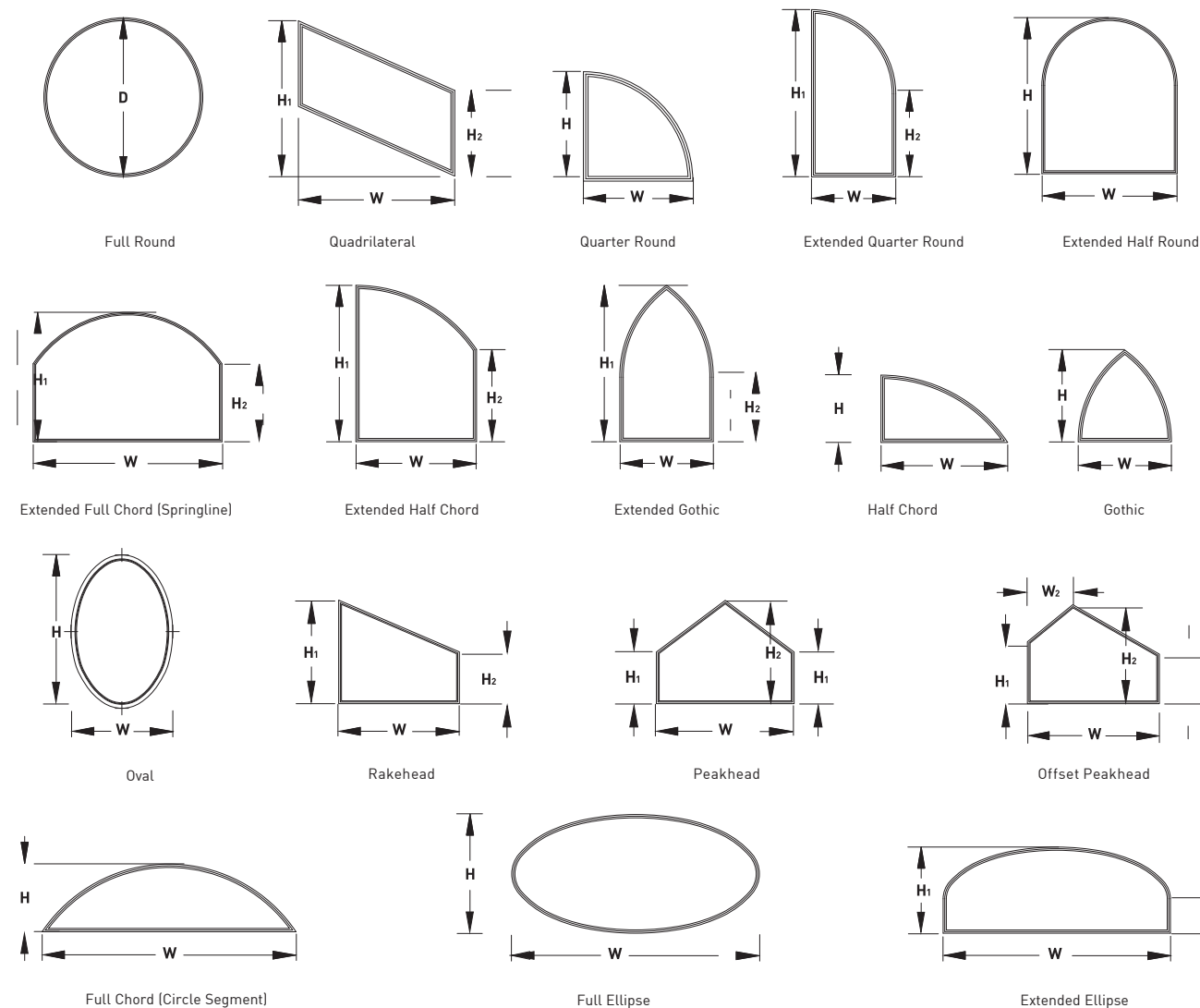

H3

www.loewen.com | 1.800.563.9367 | SPECIALTY WINDOWS

Visit the [Loewen Photo Gallery](http://www.loewen.com) online at www.loewen.com for a large collection of Loewen product and elevation photography.

Numerous custom window configuration opportunities exist — please contact your Authorized Loewen Dealer.

Specifications and technical information are subject to change without notice. Imperial and metric measurements are converted accurately. However, in some cases, industry standards cause a 1 mm variance. [Example: 3/4" is shown as 19 mm for all glass measurements.]

CAD Download and Installation Instructions: www.loewen.com

SPECIALTY WINDOW SIZES

HALF ROUND WINDOWS

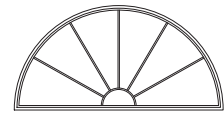
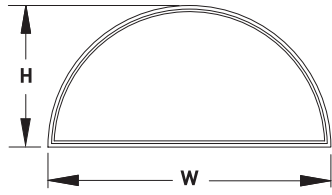

Standard Optional Grille

MODEL NUMBER	UNIT SIZES			
	UNIT O.S.M. (Imperial)	ROUGH OPENING (Imperial)	UNIT O.S.M. (Metric)	ROUGH OPENING (Metric)
RT 0603	23 5/8 X 11 13/16	24 3/8 X 12 9/16	600 X 300	619 X 319
RT 0735	27 9/16 X 13 3/4	28 5/16 X 14 1/2	700 X 350	719 X 369
RT 0804	31 1/2 X 15 3/4	32 1/4 X 16 1/2	800 X 400	819 X 419
RT 0945	35 7/16 X 17 11/16	36 3/16 X 18 7/16	900 X 450	919 X 469
RT 1005	39 3/8 X 19 11/16	40 1/8 X 20 7/16	1000 X 500	1019 X 519
RT 1206	47 1/4 X 23 5/8	48 X 24 3/8	1200 X 600	1219 X 619
RT 1407	55 1/8 X 27 9/16	55 7/8 X 28 5/16	1400 X 700	1419 X 719
RT 1608	63 X 31 1/2	63 3/4 X 32 1/4	1600 X 800	1619 X 819
RT 1809	70 7/8 X 35 7/16	71 5/8 X 36 3/16	1800 X 900	1819 X 919
RT 2010	78 3/4 X 39 3/8	79 1/2 X 40 1/8	2000 X 1000	2019 X 1019
RT 2412	94 1/2 X 47 1/4	95 1/4 X 48	2400 X 1200	2419 X 1219
RT 2613	102 3/8 X 51 3/16	103 1/8 X 51 15/16	2600 X 1300	2619 X 1319
RT 2814	110 1/4 X 55 1/8	111 X 55 7/8	2800 X 1400	2819 X 1419
RT 3015	118 1/8 X 59 1/16	118 7/8 X 59 13/16	3000 X 1500	3019 X 1519

SPECIALTY WINDOW SIZES

QUARTER ROUND WINDOWS

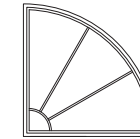
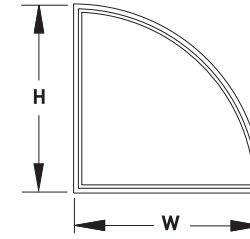

Standard Optional Grille

MODEL NUMBER	UNIT SIZES			
	UNIT O.S.M. (Imperial)	ROUGH OPENING (Imperial)	UNIT O.S.M. (Metric)	ROUGH OPENING (Metric)
QR 505	19 11/16 X 19 11/16	20 7/16 X 20 7/16	500 X 500	519 X 519
QR 606	23 5/8 X 23 5/8	24 3/8 X 24 3/8	600 X 600	619 X 619
QR 909	35 7/16 X 35 7/16	36 3/16 X 36 3/16	900 X 900	919 X 919
QR 1010	39 3/8 X 39 3/8	40 1/8 X 40 1/8	1000 X 1000	1019 X 1019
QR 1212	47 1/4 X 47 1/4	48 X 48	1200 X 1200	1219 X 1219
QR 1414	55 1/8 X 55 1/8	55 7/8 X 55 7/8	1400 X 1400	1419 X 1419

H4

www.loewen.com | 1.800.563.9367 | SPECIALTY WINDOWS

EXTENDED HALF ROUND WINDOWS

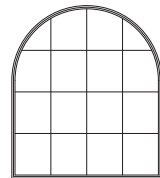
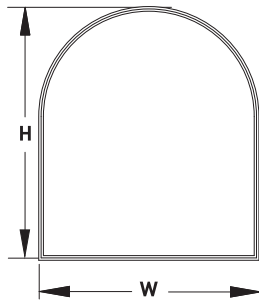

Standard Optional Grille

MODEL NUMBER	UNIT SIZES			
	UNIT O.S.M. (Imperial)	ROUGH OPENING (Imperial)	UNIT O.S.M. (Metric)	ROUGH OPENING (Metric)
ER 0810	31 1/2 X 39 3/8	32 1/4 X 40 1/8	800 X 1000	819 X 1019
ER 0812	31 1/2 X 47 1/4	32 1/4 X 48	800 X 1200	819 X 1219
ER 0814	31 1/2 X 55 1/8	32 1/4 X 55 7/8	800 X 1400	819 X 1419
ER 1010	39 3/8 X 39 3/8	40 1/8 X 40 1/8	1000 X 1000	1019 X 1019
ER 1012	39 3/8 X 47 1/4	40 1/8 X 48	1000 X 1200	1019 X 1219
ER 1014	39 3/8 X 55 1/8	40 1/8 X 55 7/8	1000 X 1400	1019 X 1419
ER 1016	39 3/8 X 63	40 1/8 X 63 3/4	1000 X 1600	1019 X 1619
ER 1018	39 3/8 X 70 7/8	40 1/8 X 71 5/8	1000 X 1800	1019 X 1819
ER 1212	47 1/4 X 47 1/4	48 X 48	1200 X 1200	1219 X 1219
ER 1214	47 1/4 X 55 1/8	48 X 55 7/8	1200 X 1400	1219 X 1419
ER 1216	47 1/4 X 63	48 X 63 3/4	1200 X 1600	1219 X 1619
ER 1218	47 1/4 X 70 7/8	48 X 71 5/8	1200 X 1800	1219 X 1819
ER 1414	55 1/8 X 55 1/8	55 7/8 X 55 7/8	1400 X 1400	1419 X 1419
ER 1416	55 1/8 X 63	55 7/8 X 63 3/4	1400 X 1600	1419 X 1619
ER 1418	55 1/8 X 70 7/8	55 7/8 X 71 5/8	1400 X 1800	1419 X 1819
ER 1616	63 X 63	63 3/4 X 63 3/4	1600 X 1600	1619 X 1619
ER 1618	63 X 70 7/8	63 3/4 X 71 5/8	1600 X 1800	1619 X 1819
ER 1818	70 7/8 X 70 7/8	71 5/8 X 71 5/8	1800 X 1800	1819 X 1819
ER 2418	94 1/2 X 70 7/8	95 1/4 X 71 5/8	2400 X 1800	2419 X 1819

Note: • SDL/Grille patterns are dependent on SDL/Grille type. All patterns shown in this catalog are for illustration purposes only – please verify SDL/Grille patterns before confirming your order.
• Specialty shape units are available in Casement and Picture/Direct Set configurations. Additional sizes beyond those shown here are available. Contact your Authorized Loewen Dealer for assistance.

Information is subject to change without notice. | CAD Download and Installation Instructions: www.loewen.com

H5

www.loewen.com | 1.800.563.9367 | SPECIALTY WINDOWS

EXTENDED QUARTER ROUND WINDOWS

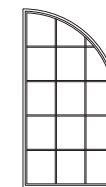
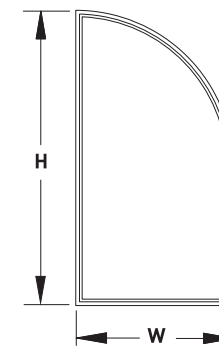

Standard Optional Grille

MODEL NUMBER	UNIT SIZES			
	UNIT O.S.M. (Imperial)	ROUGH OPENING (Imperial)	UNIT O.S.M. (Metric)	ROUGH OPENING (Metric)
EQ 0510	19 11/16 X 39 3/8	20 7/16 X 40 1/8	500 X 1000	519 X 1019
EQ 0512	19 11/16 X 47 1/4	20 7/16 X 48	500 X 1200	519 X 1219
EQ 0612	23 5/8 X 47 1/4	24 3/8 X 48	600 X 1200	619 X 1219
EQ 0614	23 5/8 X 55 1/8	24 3/8 X 55 7/8	600 X 1400	619 X 1419
EQ 0712	27 9/16 X 47 1/4	28 5/16 X 48	700 X 1200	719 X 1219
EQ 0714	27 9/16 X 55 1/8	28 5/16 X 55 7/8	700 X 1400	719 X 1419
EQ 0716	27 9/16 X 63	28 5/16 X 63 3/4	700 X 1600	719 X 1619
EQ 0814	31 1/2 X 55 1/8	32 1/4 X 55 7/8	800 X 1400	819 X 1419
EQ 0816	31 1/2 X 63	32 1/4 X 63 3/4	800 X 1600	819 X 1619
EQ 0818	31 1/2 X 70 7/8	32 1/4 X 71 5/8	800 X 1800	819 X 1819
EQ 0916	35 7/16 X 63	36 3/16 X 63 3/4	900 X 1600	919 X 1619
EQ 0918	35 7/16 X 70 7/8	36 3/16 X 71 5/8	900 X 1800	919 X 1819
EQ 1016	39 3/8 X 63	40 1/8 X 63 3/4	1000 X 1600	1019 X 1619
EQ 1018	39 3/8 X 70 7/8	40 1/8 X 71 5/8	1000 X 1800	1019 X 1819
EQ 1218	47 1/4 X 70 7/8	48 X 71 5/8	1200 X 1800	1219 X 1819
EQ 1418	55 1/8 X 70 7/8	55 7/8 X 71 5/8	1400 X 1800	1419 X 1819

Note: • SDL/Grille patterns are dependent on SDL/Grille type. All patterns shown in this catalog are for illustration purposes only – please verify SDL/Grille patterns before confirming your order.
• Specialty shape units are available in Casement and Picture/Direct Set configurations. Additional sizes beyond those shown here are available. Contact your Authorized Loewen Dealer for assistance.

Information is subject to change without notice. | CAD Download and Installation Instructions: www.loewen.com

SPECIALTY WINDOW SIZES

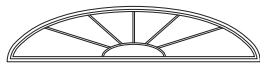
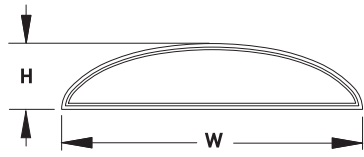

Standard Optional Grille

ELLIPTICAL WINDOWS

MODEL NUMBER	UNIT SIZES			
	UNIT O.S.M. (Imperial)	ROUGH OPENING (Imperial)	UNIT O.S.M. (Metric)	ROUGH OPENING (Metric)
EL 0800	31 1/2 X 9 13/16	32 1/4 X 10 9/16	800 X 250	819 X 269
EL 0900	35 7/16 X 9 13/16	36 3/16 X 10 9/16	900 X 250	919 X 269
EL 1000	39 3/8 X 9 13/16	40 1/8 X 10 9/16	1000 X 250	1019 X 269
EL 1200	47 1/4 X 11 13/16	48 X 12 9/16	1200 X 300	1219 X 319
EL 1400	55 1/8 X 11 13/16	55 7/8 X 12 9/16	1400 X 300	1419 X 319
EL 1600	63 X 13 3/4	63 3/4 X 14 1/2	1600 X 350	1619 X 369
EL 1800	70 7/8 X 13 3/4	71 5/8 X 14 1/2	1800 X 350	1819 X 369

SPECIALTY WINDOW SIZES

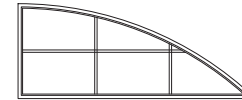
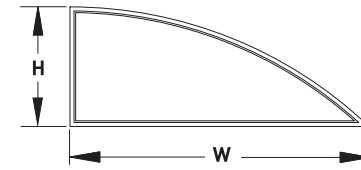

Standard Optional Grille

HALF CHORD WINDOWS

MODEL NUMBER	UNIT SIZES			
	UNIT O.S.M. (Imperial)	ROUGH OPENING (Imperial)	UNIT O.S.M. (Metric)	ROUGH OPENING (Metric)
HC 0500	19 11/16 X 9 13/16	20 13/16 X 10 9/16	500 X 250	528 X 269
HC 0600	23 5/8 X 11 13/16	24 3/4 X 12 9/16	600 X 300	628 X 319
HC 0700	27 9/16 X 11 13/16	28 13/16 X 12 9/16	700 X 300	731 X 319
HC 0800	31 1/2 X 13 3/4	32 11/16 X 14 1/2	800 X 350	831 X 369
HC 0900	35 7/16 X 13 3/4	36 3/4 X 14 1/2	900 X 350	934 X 369
HC 1000	39 3/8 X 15 3/4	40 11/16 X 16 1/2	1000 X 400	1033 X 419
HC 1200	47 1/4 X 15 3/4	48 3/4 X 16 1/2	1200 X 400	1238 X 419
HC 1400	55 1/8 X 17 11/16	56 5/8 X 18 7/16	1400 X 450	1439 X 469

H6

EXTENDED ELLIPTICAL WINDOWS

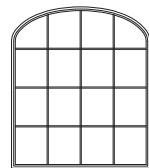
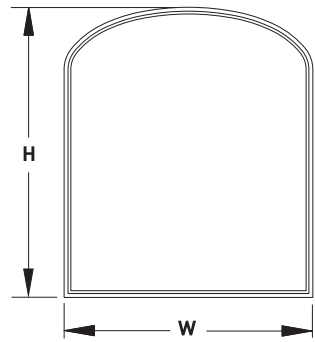

Standard Optional Grille

MODEL NUMBER	UNIT SIZES			
	UNIT O.S.M. (Imperial)	ROUGH OPENING (Imperial)	UNIT O.S.M. (Metric)	ROUGH OPENING (Metric)
EE 0808	31 1/2 X 31 1/2	32 1/4 X 32 1/4	800 X 800	819 X 819
EE 0810	31 1/2 X 39 3/8	32 1/4 X 40 1/8	800 X 1000	819 X 1019
EE 0812	31 1/2 X 47 1/4	32 1/4 X 48	800 X 1200	819 X 1219
EE 1010	39 3/8 X 39 3/8	40 1/8 X 40 1/8	1000 X 1000	1019 X 1019
EE 1012	39 3/8 X 47 1/4	40 1/8 X 48	1000 X 1200	1019 X 1219
EE 1014	39 3/8 X 55 1/8	40 1/8 X 55 7/8	1000 X 1400	1019 X 1419
EE 1212	47 1/4 X 47 1/4	48 X 48	1200 X 1200	1219 X 1219
EE 1214	47 1/4 X 55 1/8	48 X 55 7/8	1200 X 1400	1219 X 1419
EE 1216	47 1/4 X 63	48 X 63 3/4	1200 X 1600	1219 X 1619
EE 1414	55 1/8 X 55 1/8	55 7/8 X 55 7/8	1400 X 1400	1419 X 1419
EE 1416	55 1/8 X 63	55 7/8 X 63 3/4	1400 X 1600	1419 X 1619
EE 1418	55 1/8 X 70 7/8	55 7/8 X 71 5/8	1400 X 1800	1419 X 1819
EE 1616	63 X 63	63 3/4 X 63 3/4	1600 X 1600	1619 X 1619
EE 1818	70 7/8 X 70 7/8	71 5/8 X 71 5/8	1800 X 1800	1819 X 1819

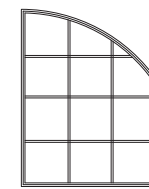
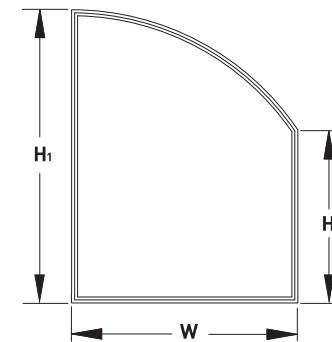

Standard Optional Grille

EXTENDED HALF CHORD WINDOWS

MODEL NUMBER	UNIT SIZES			
	UNIT O.S.M. (Imperial)	ROUGH OPENING (Imperial)	UNIT O.S.M. (Metric)	ROUGH OPENING (Metric)
EH 0512	19 11/16 X 39 3/8	20 7/16 X 40 1/8	500 X 1000	519 X 1019
EH 0510	19 11/16 X 47 1/4	20 7/16 X 48	500 X 1200	519 X 1219
EH 0612	23 5/8 X 47 1/4	24 3/8 X 48	600 X 1200	619 X 1219
EH 0614	23 5/8 X 55 1/8	24 3/8 X 55 7/8	600 X 1400	619 X 1419
EH 0712	27 9/16 X 47 1/4	28 5/16 X 48	700 X 1200	719 X 1219
EH 0714	27 9/16 X 55 1/8	28 5/16 X 55 7/8	700 X 1400	719 X 1419
EH 0716	27 9/16 X 63	28 5/16 X 63 3/4	700 X 1600	719 X 1619
EH 0814	31 1/2 X 55 1/8	32 1/4 X 55 7/8	800 X 1400	819 X 1419
EH 0816	31 1/2 X 63	32 1/4 X 63 3/4	800 X 1600	819 X 1619
EH 0818	31 1/2 X 70 7/8	32 1/4 X 71 5/8	800 X 1800	819 X 1819
EH 0916	35 7/16 X 63	36 3/16 X 63 3/4	900 X 1600	919 X 1619
EH 0918	35 7/16 X 70 7/8	36 3/16 X 71 5/8	900 X 1800	919 X 1819
EH 1016	39 3/8 X 63	40 1/8 X 63 3/4	1000 X 1600	1019 X 1619
EH 1018	39 3/8 X 70 7/8	40 1/8 X 71 5/8	1000 X 1800	1019 X 1819
EH 1218	47 1/4 X 70 7/8	48 X 71 5/8	1200 X 1800	1219 X 1819
EH 1418	55 1/8 X 70 7/8	55 7/8 X 71 5/8	1400 X 1800	1419 X 1819

Note: • SDL/Grille patterns are dependent on SDL/Grille type. All patterns shown in this catalog are for illustration purposes only – please verify SDL/Grille patterns before confirming your order.
• Specialty shape units are available in Casement and Picture/Direct Set configurations. Additional sizes beyond those shown here are available. Contact your Authorized Loewen Dealer for assistance.

Note: • SDL/Grille patterns are dependent on SDL/Grille type. All patterns shown in this catalog are for illustration purposes only – please verify SDL/Grille patterns before confirming your order.
• Specialty shape units are available in Casement and Picture/Direct Set configurations. Additional sizes beyond those shown here are available. Contact your Authorized Loewen Dealer for assistance.

H7

SPECIALTY WINDOW SIZES

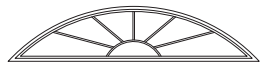
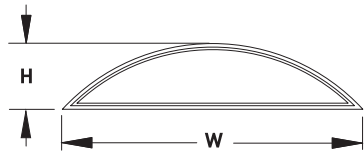

Standard Optional Grille

FULL CHORD WINDOWS

UNIT SIZES				
MODEL NUMBER	UNIT O.S.M. (Imperial)	ROUGH OPENING (Imperial)	UNIT O.S.M. (Metric)	ROUGH OPENING (Metric)
FC 0800	31 1/2 X 9 13/16	32 11/16 X 10 9/16	800 X 250	830 X 269
FC 0900	31 1/2 X 9 13/16	36 3/4 X 10 9/16	900 X 250	934 X 269
FC 1000	39 3/8 X 9 13/16	40 13/16 X 10 9/16	1000 X 250	1037 X 269
FC 1200	47 1/4 X 11 13/16	48 11/16 X 12 9/16	1200 X 300	1237 X 319
FC 1400	55 1/8 X 11 13/16	56 13/16 X 12 9/16	1400 X 300	1444 X 319
FC 1600	63 X 13 3/4	64 11/16 X 14 1/2	1600 X 350	1643 X 369
FC 1800	70 7/8 X 13 3/4	72 3/4 X 14 1/2	1800 X 350	1848 X 369

SPECIALTY WINDOW SIZES

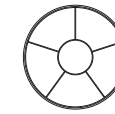
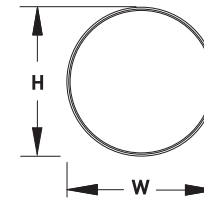

Standard Optional Grille

FULL ROUND WINDOWS

UNIT SIZES				
MODEL NUMBER	UNIT O.S.M. (Imperial)	ROUGH OPENING (Imperial)	UNIT O.S.M. (Metric)	ROUGH OPENING (Metric)
FR 0606	23 5/8 X 23 5/8	24 3/8 X 24 3/8	600 X 600	619 X 619
FR 0808	31 1/2 X 31 1/2	32 1/4 X 32 1/4	800 X 800	819 X 819
FR 0909	35 7/16 X 35 7/16	36 3/16 X 36 3/16	900 X 900	919 X 919
FR 1010	39 3/8 X 39 3/8	40 1/8 X 40 1/8	1000 X 1000	1019 X 1019
FR 1212	47 1/4 X 47 1/4	48 X 48	1200 X 1200	1219 X 1219
FR 1414	55 1/8 X 55 1/8	55 7/8 X 55 7/8	1400 X 1400	1419 X 1419
FR 1616	63 X 63	63 3/4 X 63 3/4	1600 X 1600	1619 X 1619
FR 1818	70 7/8 X 70 7/8	71 5/8 X 71 5/8	1800 X 1800	1819 X 1819

OCTAGON WINDOWS

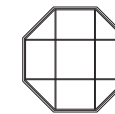
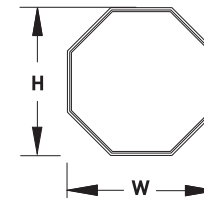

Standard Optional Grille

UNIT SIZES				
MODEL NUMBER	UNIT O.S.M. (Imperial)	ROUGH OPENING (Imperial)	UNIT O.S.M. (Metric)	ROUGH OPENING (Metric)
OW 0606	23 5/8 X 23 5/8	24 3/8 X 24 3/8	600 X 600	619 X 619
OW 0808	31 1/2 X 31 1/2	32 1/4 X 32 1/4	800 X 800	819 X 819
OW 1010	39 3/8 X 39 3/8	40 1/8 X 40 1/8	1000 X 1000	1019 X 1019

OVAL WINDOWS

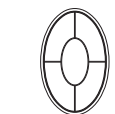
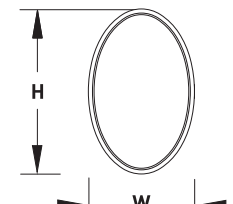

Standard Optional Grille

UNIT SIZES				
MODEL NUMBER	UNIT O.S.M. (Imperial)	ROUGH OPENING (Imperial)	UNIT O.S.M. (Metric)	ROUGH OPENING (Metric)
OV 7512	29 1/2 X 47 1/4	30 1/4 X 48	750 X 1200	769 X 1219
OV 0914	35 7/16 X 55 1/8	36 3/16 X 55 7/8	900 X 1400	919 X 1419
OV 1275	47 1/4 X 29 1/2	48 X 30 1/4	1200 X 750	1219 X 769
OV 1409	55 1/8 X 35 7/16	55 7/8 X 36 3/16	1400 X 900	1419 X 919

EXTENDED FULL CHORD WINDOWS

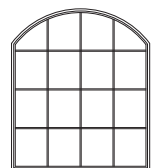
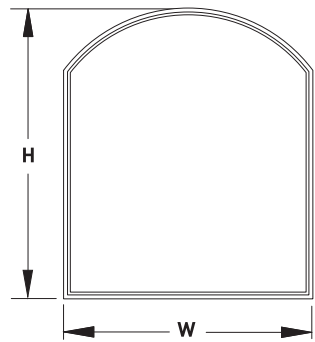

Standard Optional Grille

UNIT SIZES				
MODEL NUMBER	UNIT O.S.M. (Imperial)	ROUGH OPENING (Imperial)	UNIT O.S.M. (Metric)	ROUGH OPENING (Metric)
EF 0808	31 1/2 X 31 1/2	32 1/4 X 32 1/4	800 X 800	819 X 819
EF 0810	31 1/2 X 39 3/8	32 1/4 X 40 1/8	800 X 1000	819 X 1019
EF 0812	31 1/2 X 47 1/4	32 1/4 X 48	800 X 1200	819 X 1219
EF 1010	39 3/8 X 39 3/8	40 1/8 X 40 1/8	1000 X 1000	1019 X 1019
EF 1012	39 3/8 X 47 1/4	40 1/8 X 48	1000 X 1200	1019 X 1219
EF 1014	39 3/8 X 55 1/8	40 1/8 X 55 7/8	1000 X 1400	1019 X 1419
EF 1212	47 1/4 X 47 1/4	48 X 48	1200 X 1200	1219 X 1219
EF 1214	47 1/4 X 55 1/8	48 X 55 7/8	1200 X 1400	1219 X 1419
EF 1216	47 1/4 X 63	48 X 63 3/4	1200 X 1600	1219 X 1619
EF 1414	55 1/8 X 55 1/8	55 7/8 X 55 7/8	1400 X 1400	1419 X 1419
EF 1416	55 1/8 X 63	55 7/8 X 63 3/4	1400 X 1600	1419 X 1619
EF 1418	55 1/8 X 70 7/8	55 7/8 X 71 5/8	1400 X 1800	1419 X 1819
EF 1616	63 X 63	63 3/4 X 63 3/4	1600 X 1600	1619 X 1619
EF 1618	70 7/8 X 70 7/8	71 5/8 X 71 5/8	1600 X 1800	1619 X 1819
EF 1818	70 7/8 X 70 7/8	71 5/8 X 71 5/8	1800 X 1800	1819 X 1819

Note: • SDL/Grille patterns are dependent on SDL/Grille type. All patterns shown in this catalog are for illustration purposes only – please verify SDL/Grille patterns before confirming your order.
• Specialty shape units are available in Casement and Picture/Direct Set configurations. Additional sizes beyond those shown here are available. Contact your Authorized Loewen Dealer for assistance.

Note: • SDL/Grille patterns are dependent on SDL/Grille type. All patterns shown in this catalog are for illustration purposes only – please verify SDL/Grille patterns before confirming your order.
• Specialty shape units are available in Casement and Picture/Direct Set configurations. Additional sizes beyond those shown here are available. Contact your Authorized Loewen Dealer for assistance.

SPECIALTY WINDOW SIZES

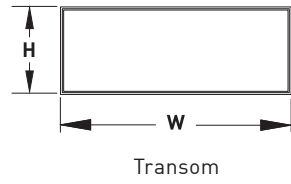

TRANSOM

UNIT SIZES				
MODEL NUMBER	UNIT O.S.M. (Imperial)	ROUGH OPENING (Imperial)	UNIT O.S.M. (Metric)	ROUGH OPENING (Metric)
TR 0403	15 3/4 X 11 13/16	16 1/2 X 12 9/16	400 X 300	419 X 319
TR 0503	19 11/16 X 11 13/16	20 7/16 X 12 9/16	500 X 300	519 X 319
TR 0603	23 5/8 X 11 13/16	24 3/8 X 12 9/16	600 X 300	619 X 319
TR 0703	27 9/16 X 11 13/16	28 5/16 X 12 9/16	700 X 300	719 X 319
TR 7503	29 1/2 X 11 13/16	30 1/4 X 12 9/16	750 X 300	769 X 319
TR 0803	31 1/2 X 11 13/16	32 1/4 X 12 9/16	800 X 300	819 X 319
TR 0903	35 7/16 X 11 13/16	36 3/16 X 12 9/16	900 X 300	919 X 319
TR 1003	39 3/8 X 11 13/16	40 1/8 X 12 9/16	1000 X 300	1019 X 319
TR 1203	47 1/4 X 11 13/16	48 X 12 9/16	1200 X 300	1219 X 319
TR 1403	55 1/8 X 11 13/16	55 7/8 X 12 9/16	1400 X 300	1419 X 319
TR 1603	63 X 11 13/16	63 3/4 X 12 9/16	1600 X 300	1619 X 319
TR 1803	70 7/8 X 11 13/16	71 5/8 X 12 9/16	1800 X 300	1819 X 319
TR 0404	15 3/4 X 15 3/4	16 1/2 X 16 1/2	400 X 400	419 X 419
TR 0504	19 11/16 X 15 3/4	20 7/16 X 16 1/2	500 X 400	519 X 419
TR 0604	23 5/8 X 15 3/4	24 3/8 X 16 1/2	600 X 400	619 X 419
TR 0704	27 9/16 X 15 3/4	28 5/16 X 16 1/2	700 X 400	719 X 419
TR 7504	29 1/2 X 15 3/4	30 1/4 X 16 1/2	750 X 400	769 X 419
TR 0804	31 1/2 X 15 3/4	32 1/4 X 16 1/2	800 X 400	819 X 419
TR 0904	35 7/16 X 15 3/4	36 3/16 X 16 1/2	900 X 400	919 X 419
TR 1004	39 3/8 X 15 3/4	40 1/8 X 16 1/2	1000 X 400	1019 X 419
TR 1204	47 1/4 X 15 3/4	48 X 16 1/2	1200 X 400	1219 X 419
TR 1404	55 1/8 X 15 3/4	55 7/8 X 16 1/2	1400 X 400	1419 X 419
TR 1604	63 X 15 3/4	63 3/4 X 16 1/2	1600 X 400	1619 X 419
TR 1804	70 7/8 X 15 3/4	71 5/8 X 16 1/2	1800 X 400	1819 X 419

Note: • SDL/Grille patterns are dependent on SDL/Grille type. All patterns shown in this catalog are for illustration purposes only – please verify SDL/Grille patterns before confirming your order.
 • Specialty shape units are available in Casement and Picture/Direct Set configurations. Additional sizes beyond those shown here are available. Contact your Authorized Loewen Dealer for assistance.

SPECIALTY WINDOW WALL CONNECTION DETAIL

HEAD & SILL DETAIL

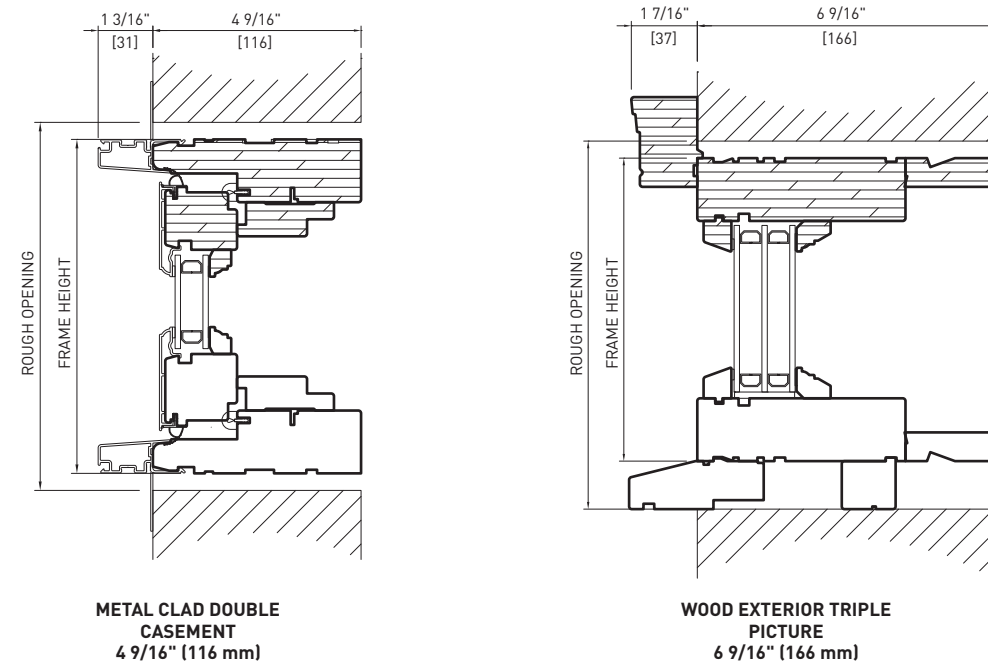

PLAN VIEW

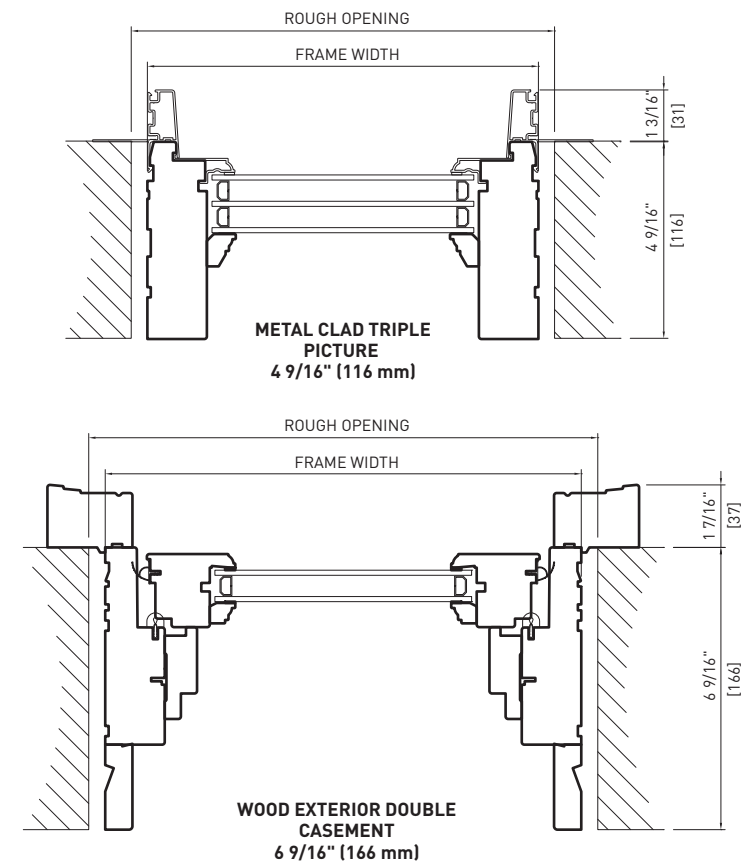

Note: • Other jamb widths available.
 • All dimensions to have +/- 1/16" (2 mm) tolerance.



NON-EXTENDED SPECIALTY WINDOW DETAIL

HEAD & SILL DETAIL

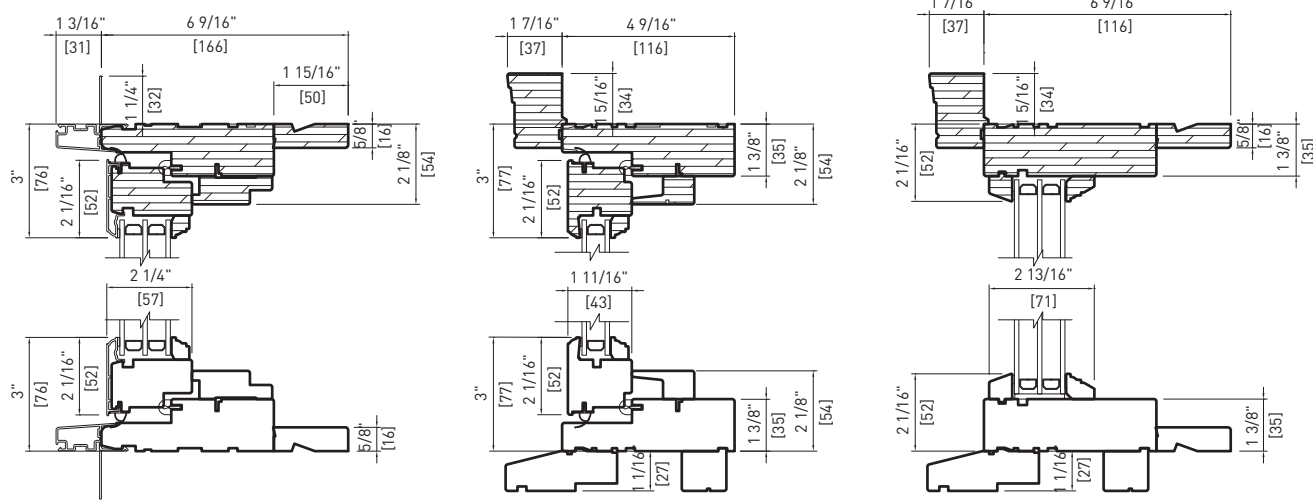

METAL CLAD CASEMENT TRIPLE
6 9/16" (166 mm)
ROTO GEAR MOULDINGS

WOOD CASEMENT DOUBLE
4 9/16" (116 mm)
PUSH OUT MOULDINGS
2" BRICKMOULD WITH STANDARD SUBSILL

WOOD PICTURE TRIPLE
6 9/16" (166 mm)
2" BRICKMOULD WITH STANDARD SUBSILL

EXTENDED SPECIALTY WINDOW DETAIL

HEAD & SILL DETAIL

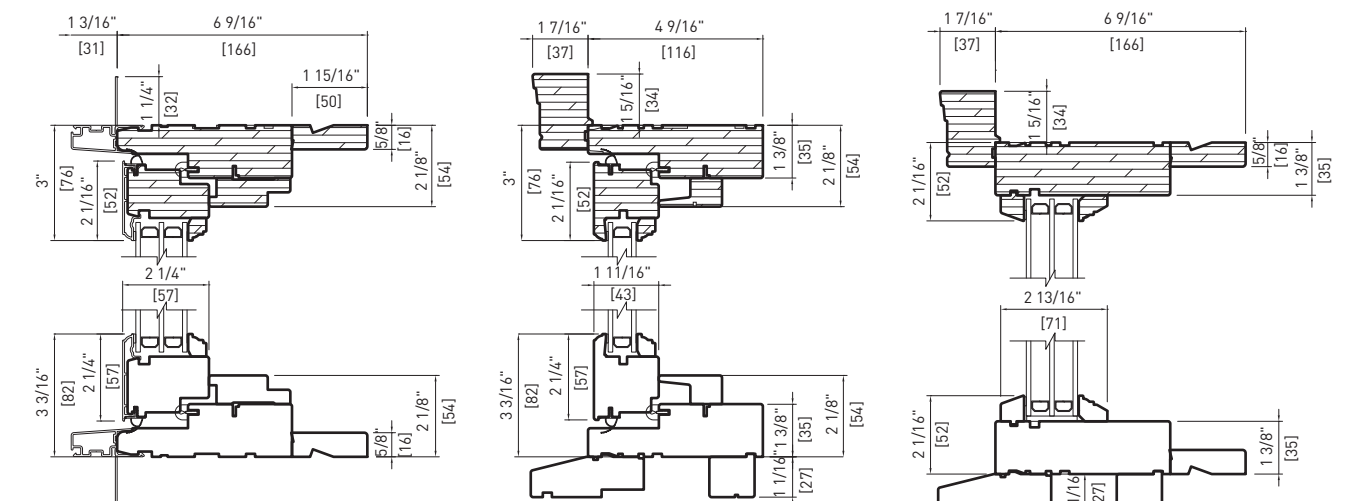

METAL CLAD CASEMENT TRIPLE
ROTO GEAR MOULDINGS

WOOD CASEMENT DOUBLE
4 9/16" (116 mm)
PUSH OUT MOULDINGS
2" BRICKMOULD WITH STANDARD SUBSILL

WOOD PICTURE TRIPLE
6 9/16" (166 mm)
2" BRICKMOULD WITH STANDARD SUBSILL

HEAD & SILL DETAIL

PLAN VIEW

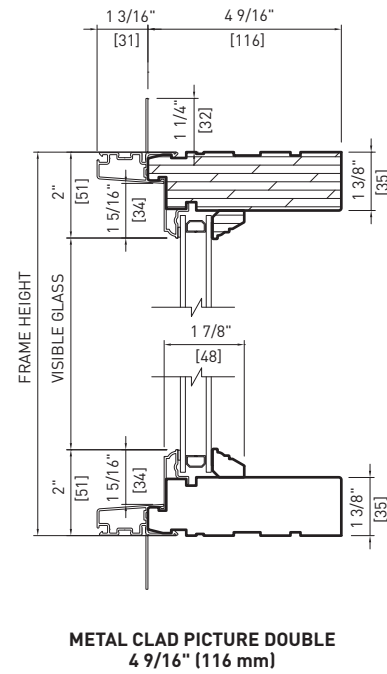

METAL CLAD PICTURE DOUBLE
4 9/16" (116 mm)

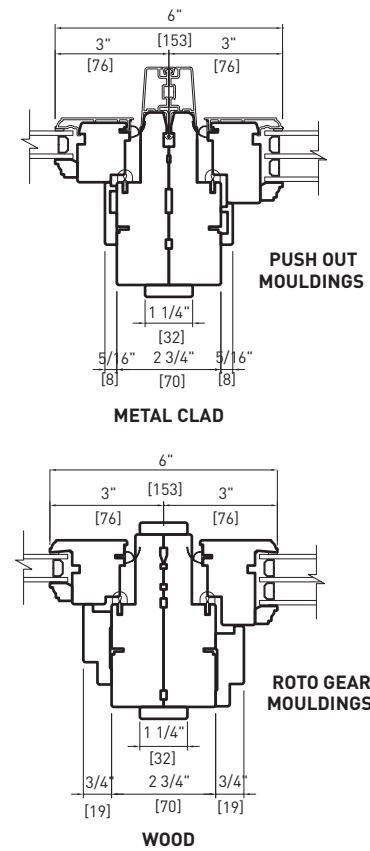

METAL CLAD

ROTO GEAR MOULDINGS

WOOD

HEAD & SILL DETAIL

PLAN VIEW

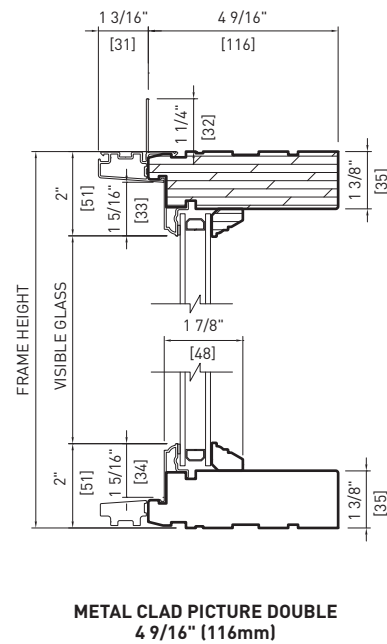

METAL CLAD PICTURE DOUBLE
4 9/16" (116mm)

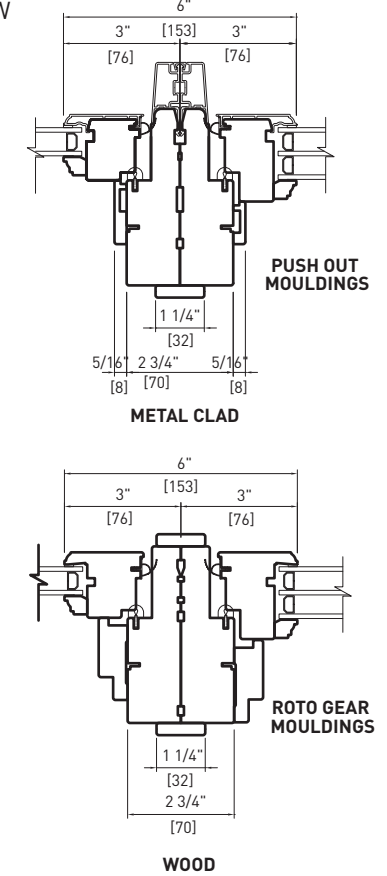

METAL CLAD

ROTO GEAR MOULDINGS

WOOD

Note: • Other jamb widths available.
• All dimensions to have +/- 1/16" [2 mm] tolerance.



RADIUS COMPONENT

Note: • Other jamb widths available.
• All dimensions to have +/- 1/16" [2 mm] tolerance.



RADIUS COMPONENT

