



WINDOW & DOOR TECHNICAL GUIDE

Details, Sizing & Specifications



LOEWEN WINDOWS & DOORS

Loewen is the leading manufacturer of premium windows and doors for the luxury architectural market in North America and abroad.

Handcrafted

We are committed to producing handcrafted windows and doors. Our expert artisans ensure our fit-and-finish is unparalleled. These craftspeople are supported by high-tech, automated technologies, but it's the skilled hands in our makerspaces that have earned us our reputation among discerning architects, builders, and homeowners.

Authentic

We use authentic materials of the highest quality. At our core, Loewen is a designer and manufacturer of wood windows and doors. We use solid wood laminations, not veneers. Our extruded aluminum is the highest quality. Our operating hardware is bronze, brass, zinc, and stainless steel - all genuine materials, not imitations.

Enduring

Our designs are Enduring, both aesthetically and in performance. We work tirelessly to create products that are timeless, whether that means being true to historical architecture or by creating a lasting contemporary design. Behind the outward beauty is a functional performance that gives you an industry-leading experience for years to come.

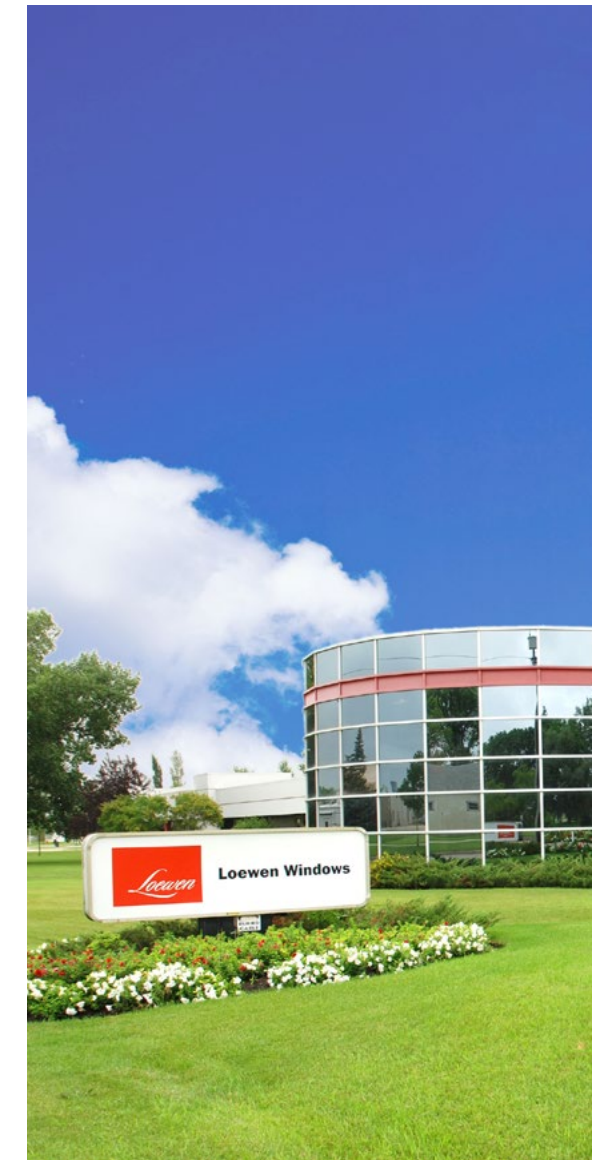

CONTENTS

Wood Species	A6
Aluminum Cladding	A7
Timber Curtain Wall	A8
Cyprium Collection	A9
Custom Shop	A10
Architectural Services	A11
Loewen Basics	A13
Environmental Commitment	A14
Certifications & Associations	A15
Our Guarantee	A16
Color & Cladding	A18
Interior Paints & Stains	A22
Durability & Versatility	A24
Window Hardware	A26
Door Hardware	A30
Glazing Options	A36
Specialty Glazing	A40
Divided Lites and Grilles	A42
CAD Drawings & Specifications	A49

Other Sections

Casement Windows	Section B
Awning Windows	Section C
Picture/Direct Set Windows	Section D
Double/Single Hung Windows	Section E
Bow, Bay & Corner Windows	Section F
Specialty Windows	Section G
Swinging Terrace Doors	Section H
Sliding Patio Doors	Section J
Bifold Doors	Section K
LiftSlide Doors	Section L
MultiSlide Doors	Section M
Timber Curtain Wall	Section N

Supplemental Guides

Cyprium Collection	Section P
StormForce	Section S



WOOD SPECIES

Authenticity is at the core of our product design, we continuously utilize genuine materials.

Coastal Douglas Fir - Our Standard

Douglas Fir is North America's most plentiful softwood species; Loewen provides Coastal Douglas Fir as our standard because it is the best species for luxury projects. Coastal Douglas Fir is the premium grade of Douglas Fir, being the strongest and most durable of all the soft woods. Not only does it give our products a rich, warm texture, it is also remarkably tough and resilient. By choosing Coastal Douglas Fir as our standard we promise a beautiful future for our customers.

FEATURES

The strength of Coastal Douglas Fir lies in its high natural resistance to moisture absorption, decay, and insect infestation

Coastal Douglas Fir out-performs other Douglas Fir species and vastly outperforms other soft wood species (such as pine, etc.)

Solid Coastal Douglas Fir is our standard where it is an upgrade for others; when offered as an upgrade, many of our competitors typically only provide it as a thin veneer over lesser materials

Available in many window and door configurations:

Windows Awning, Casement, Double Hung, Direct Set, Timber Curtain Wall, Specialty shapes and Custom configurations

Doors Terrace Swing, Sliding Patio, Bifold, MultiSlide and LiftSlide



ALUMINUM CLADDING

Our extruded aluminum cladding is intricately detailed and withstands serious impact without sustaining damage.

Loewen uses only pre-finished extruded aluminum cladding to better protect window and door exteriors and eliminate the need for painting. Our thick extruded aluminum cladding retains its shape, resists denting and lasts longer than roll-formed aluminum. In addition, Loewen's window cladding is set away from the underlying wood, creating an airspace that improves performance.

FEATURES

Withstands serious impact without sustaining damage

Allows intricate extrusion detailing

Provides the malleability necessary to clad many sizes and shapes

Delivers unequalled environmental durability

Provides a stable substrate that enhances paint and anodized performance

Available in many window and door configurations:

Windows Awning, Casement, Double Hung, Direct Set, Timber Curtain Wall, Specialty shapes and Custom configurations

Doors Terrace Swing, Sliding Patio, Bifold, MultiSlide and LiftSlide



TIMBER CURTAIN WALL

Stunning Panoramic Vistas are Here

The Loewen Timber Curtain Wall system embodies the spirit of contemporary architecture with minimal framing and cleaner sightlines, allowing for the most expansive views. Configuration options are limitless, including vertical walls, rake-heads, corner units, and integrated operable windows and doors.



CYPRUM COLLECTION

Living Finishes in Copper and Bronze

Loewen Cyprium features copper and bronze clad windows and doors unique in design and construction. The Cyprium collection is artisanal in detail, including hand-soldered exterior joints and rich, tactile depth of texture in the thick metal cladding and deep profiles.

These hand-wrought living surfaces develop distinctive patinas that adopt and define the individual aesthetic character of the homes to which they belong.

Available in many window and door configurations:

Windows Awning, Casement, Picture/Direct Set, Specialty Shapes and Custom Configurations

Doors Swinging Terrace and LiftSlide (through DDS approval)



CUSTOM SHOP

Our highly regarded Custom Shop works in unison with our customers to create unique, made-to-order pieces.

We understand that no two projects are exactly alike. Design is fluid and ever changing, and our highly-regarded Custom Shop works in unison with our customers to create distinctive pieces based on their specific design requests. Whether you are looking for custom glazing, custom species, distressing, stains, or custom exterior casings, we can provide a solution for you.

EXAMPLES OF CUSTOM OPERATIONS AND CONFIGURATIONS

Large pivot doors

Custom entry doors

Strut operated pass through awnings

Tilt/turn window

Dutch doors

Inswing Casements

Hoppers

Pre-finishing (paint or stain)

Available in various window and door configurations.

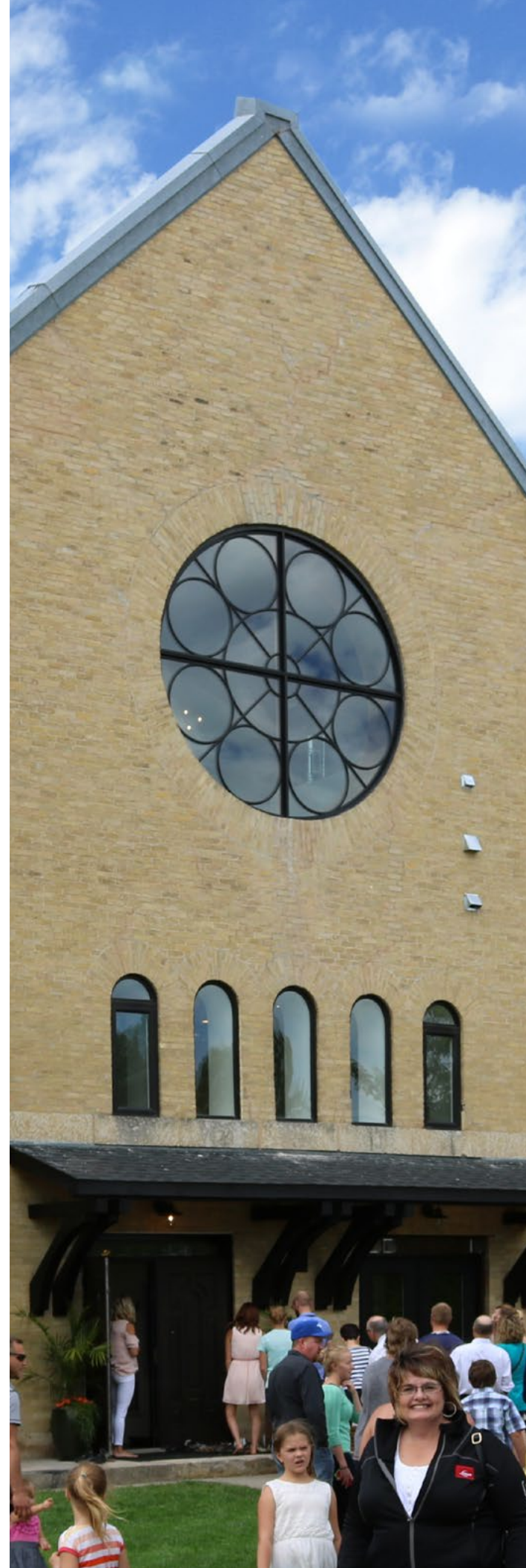

ARCHITECTURAL SERVICES

Loewen's Architectural Services division was created with the imagination and passion of Architects in mind. This consultative service connects Loewen's technical expertise and manufacturing experience with visionaries who live to design, create and inspire.

Contact us by email

architecture@loewen.com

Contact us by phone

United States or Canada: 800.563.9367

Outside of North America: 431.305.0888

Dealer Network

In addition to Loewen's Architectural Services, our large dealer network including territory managers and sales professionals throughout Canada and the United States serve and assist the architectural community. These Loewen professionals are able to provide detailed information, service and pricing for all Loewen products.

Loewen representatives are available for informative product demonstrations, office/site visits, architectural luncheons (which may qualify for AIA Continuing Education Credits), or other functions that require fenestration expertise.

Product Samples & Displays

Portable product samples and displays are available through Loewen Territory Managers and the dealer network. These tools aid in understanding product differences and features.

Loewen products are displayed at trade and home shows, including large national conferences and local exhibitions.



Performance

Our windows and doors are among the highest performing in the industry. Performance keeps homes comfortable and energy efficient, and strength protects against the worst nature can deliver. We achieve this through a commitment to produce the highest quality products possible, using only the highest quality materials. Loewen provides solutions ideal for diverse environments from the cold, harsh North to sunny South and tropical storm threatened regions

Loewen products are engineered to comply with and exceed building codes in North America. Each test is conducted by an independent agency and is based on extreme conditions and varying product sizes. Code compliance is a fundamental aspect of our product design. Many of our products meet the performance requirements for Energy Star™. The National Fenestration Rating Council empirically shows that Loewen products are among the industry's best in terms of thermal performance.

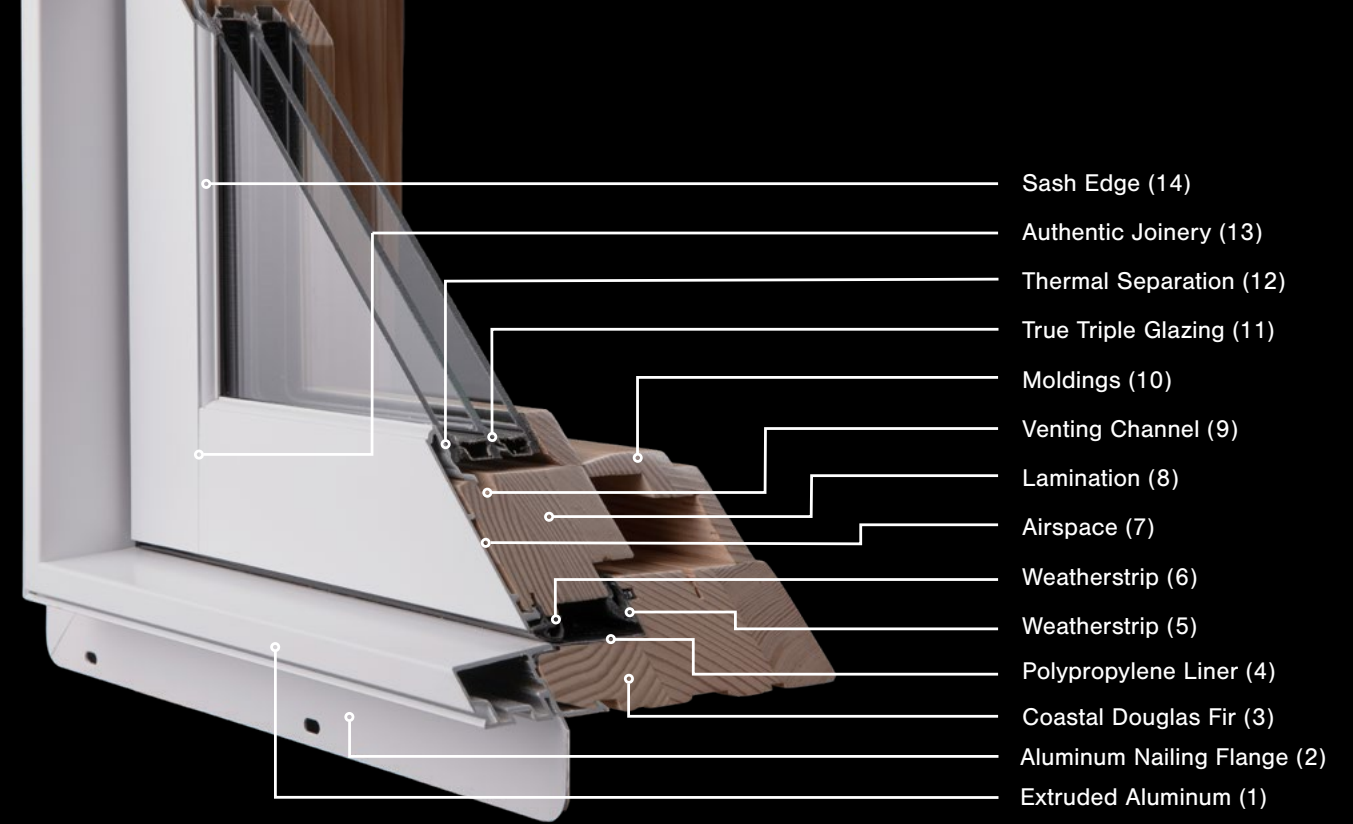

LOEWEN BASICS

Our highly customizable product offering is engineered for uncommon strength and durability.

1. Extruded aluminum cladding is intricately detailed, withstanding serious impact without sustaining damage.
2. Integral aluminum nailing flange ensures a secure installation and added weather protection.
3. Coastal Douglas Fir for strength and rigidity.
4. Polypropylene liner for added weather protection.
5. Continuous primary weather-stripping for maximum protection against air and water infiltration.
6. Secondary weatherstrip to deflect winddriven rain from primary seal.
7. Airspace between cladding and wood for air circulation and added insulation value.
8. Laminated wood components for enhanced structural stability and a tight weather seal.
9. Hidden venting channel allows condensation to escape, increasing seal and sash life.
10. Solid wood moldings as opposed to thin veneers.
11. 1/2" airspace is the optimum performance-spec when using an Argon Gas fill.
12. No metal-to-glass contact improves energy efficiency.
13. Authentic stile and rail construction with mortise and tenon sash corner joinery for structural stability.
14. Sash edge provides a finished look and integrates beautifully with Simulated Divided Lite (SDL) bars.

Corner section shown is a triple glazed rotogear casement with a clear coat Coastal Douglas Fir interior and Alpine White aluminum clad exterior. Other windows and doors may vary in construction and performance.

ENVIRONMENTAL COMMITMENT

Environmental stewardship is aligned with many of the core values that are present in Loewen. We understand our customers' commitment to environmental sensibility and our brand reflects our commitment to alleviating our environmental footprint.

We practice environmental stewardship in not only our manufacturing processes, but in our product offering as well. Nearly 100% of the wood fiber used in the production of Loewen products is derived from forests that are sustainably harvested. Some of the certification include Canadian Standards Association (CSA) certified, and Programme for the Endorsement of Forest Certification (PEFC).



Loewen's outstanding energy efficiency attributes and use of sustainable materials are ideal for use in structures designed under LEED (Leadership in Energy and Environmental Design).

Loewen is a socially responsible corporation, buying ethically manufactured products and recognized for our leadership in energy conservation and environmental protection. We prove the success of our brand through our environmental commitment.

Loewen was the recipient of the Tree Canada Foundation Eterne Award, honoring us for "environmental leadership and commitment to taking action on global climate change through the planting of trees."

We recycle virtually all of the wood waste created in the manufacturing process. For example, during our frigid Canadian winters, we even heat our plant with sawdust. We also recycle glass, aluminum, weatherstripping, solvents, motor oil and paper.



Loewen seeks to reduce-reuse-recycle. We understand the dynamics of down-cycling and aggressively design systems optimally efficient in consumption. Loewen builds windows and doors of the highest quality to ensure long product life.

To this end, our products are made to be repaired and can be removed and re-installed. Once again, product quality is at the crossroads of efficiency and responsible design.

By manufacturing wood windows and doors, we use a renewable resource and an efficient natural insulator that consumes less energy than alternative materials in a home. And, because wood is the foundation of our business —everything that we do relies on this resource — we support re-forestation initiatives.

CERTIFICATIONS & ASSOCIATIONS

Loewen windows and doors are engineered to comply with — and exceed — building codes in North America and beyond. Each test is conducted by an independent agency, based on extreme conditions and varying product sizes. Code compliance is a fundamental aspect of Loewen design and engineering.



National Fenestration Rating Council (NFRC)
Our products are empirically shown to be among the industry's best in terms of thermal performance.



Window & Door Manufacturers Association (WDMA)
Hallmark Certification verifies that manufactured products are the same as tested products.



Texas Department Of Insurance (TDI)
The TDI is a dynamic leader in responsible state, national, and global regulation, consumer protection, and market viability.



Florida Building Code
The Florida Building Code is the strictest code in the United States for resistance to wind-borne debris and wind-loading for fenestration products. Many Loewen certified products meet high velocity wind zone 4 standards.



Efficient Windows Collaborative
Loewen is a founding member of the U.S. Department of Energy's Efficient Windows Collaborative.



Fenestration Canada

*Not all products meet every certification.

OUR GUARANTEE

Support, Consideration and Service

Our warranty is the written proof of our commitment to quality. Loewen windows and doors are made to last, and we have always stood behind our product with unsurpassed support, follow up, and service.

The strength of a warranty is based on the quality of the windows and doors and the confidence of the company behind them. When you have been building custom windows and doors for decades, you know that the first step in having a credible warranty is the integrity of your products.



THE LOEWEN ADVANTAGE

Full 20-year warranty on glass, wood components, and paint finishes on clad product.

We guarantee our products for the full length of our warranty, meaning our support does not reduce over time.

Complete coverage for all color finishes on our aluminum clad exterior including protection against fading and chalking for 20 years.

Full 10-year coastal warranty on painted finishes within one mile of the coastline.

Fully supported warranty service with our network of Loewen experts and regional dealer inspections.

Full 2 years labor warranty.

COMPETITION WARRANTIES

May promote a longer warranty even if it is limited or not inclusive for all parts.

May be prorated warranties that reduce the manufacturer's liability as the product ages.

Vinyl and wood fiber clad exteriors may carry a color fade only warranty or none at all.

Warranties on paint that extend past those of the paint specifications will not extend the life of the paint finish and are always limited.

Warranties that cover various distances from the coast often do not consider the specific effects of coastal weather conditions.

Confusing language - for example: a lifetime warranty against corrosion for an exterior component that contains no metals really needs to cover against UV deterioration and chalking.



Coates Design

COLOR & CLADDING

Superior Aluminum Cladding

Loewen uses only pre-finished extruded aluminum cladding to better protect window and door exteriors and eliminate the need for painting. Our thick extruded aluminum cladding retains its shape, resists denting and lasts longer than roll-formed aluminum. In addition, Loewen's window cladding is set away from the underlying wood, creating an airspace that improves thermal performance.

The broad variation in Loewen sizes, shapes and designs and the demanding environmental conditions that our product encounters require an alloy that has the ability to:

Withstand serious impact without sustaining damage

Allow intricate extrusion detailing

Provide the malleability necessary to clad many sizes and shapes

Deliver unequalled environmental durability

Provide a stable substrate that enhances colorfast paint performance

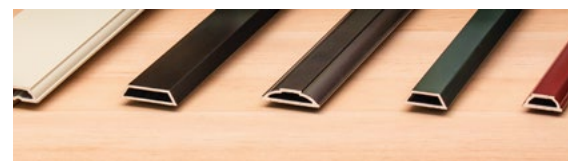

AAMA 2605 / 70% Kynar Finishes

Loewen's finish palette provides the perfect finishing touch for fulfilling your vision, while also providing industry leading quality and performance. Loewen's paint formula includes 70% Kynar 500 PVDF (polyvinylidene fluoride) resin, which offers the greatest resistance to weathering, fading and chalking. This ensures a beautiful finish that will last when cared for properly. With excellent appearance and durability, these paints meet the specifications of the American Architectural Manufacturers Association (AAMA) 2605.



STANDARD PALETTE

Painted Clad Finishes (AAMA 2605 / 70% Kynar)

Loewen's finish palette provides the perfect finishing touch for fulfilling your vision, while also providing industry leading quality and performance. Loewen's paint formula includes 70% Kynar 500 PVDF (polyvinylidene fluoride) resin, which offers the greatest resistance to weathering, fading and chalking. This ensures a beautiful finish that will last with minimal maintenance. With excellent appearance and durability, these paints meet the specifications of the American Architectural Manufacturers Association (AAMA) 2605.



Anodized Finishes (AAMA 611)

For a durable alternative to paints and organic coatings, our Anodized Finishes offer a rich matte look that reduces sunlight glare and allows the aluminum to maintain its metallic appearance. In addition to the aesthetically desirable etching, our Anodized Finishing also increases resistance to abrasion and corrosion on aluminum. This aluminum is 100% recyclable and uses a waterbased process with no volatile organic compounds for eco-friendliness.

**Anodized finishes are not recommended in coastal environments*

Due to technical print limitations colors and finishes may not be exactly as shown

CUSTOM PALETTE

Enhancing our Standard Palette, our Custom Palette includes a few extra anodized finishes and the option to configure your own custom paint colors. The integral cross matching system and color approval process ensures that you get the exact custom paint color you want every time.

ADDITIONAL ANODIZED FINISHES

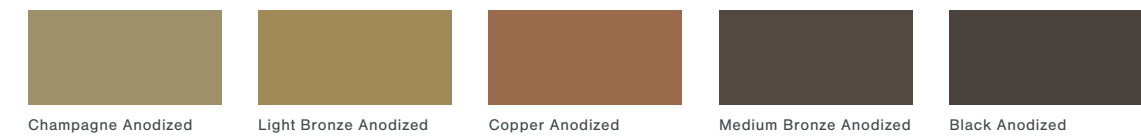

EXAMPLES OF CUSTOM PAINT COLORS



Due to technical print limitations colors and finishes may not be exactly as shown

Interior Paint Prefinishing

Loewen offers two standard factory applied, interior paint finishes for Douglas Fir units. Pre-finishing is available in Jet Black or Oxford White.

All components are prepped and painted before final unit assembly. The application includes multi-step process including sanding between coats as well as time in the drying ovens. The coatings are a premium waterborne finish of a proprietary blend of self-crosslinking acrylic and urethane resins that are specially formulated to provide exceptional finish properties.

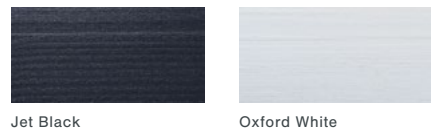

Jet Black Oxford White



Interior/Exterior Stains & Distressing

We offer stains for our wood products through our Custom Shop. Our expert craftspeople ensure that stains are accurately and consistently applied for an enduring finish. In addition to staining, optional wire-brushed distressing can be applied.

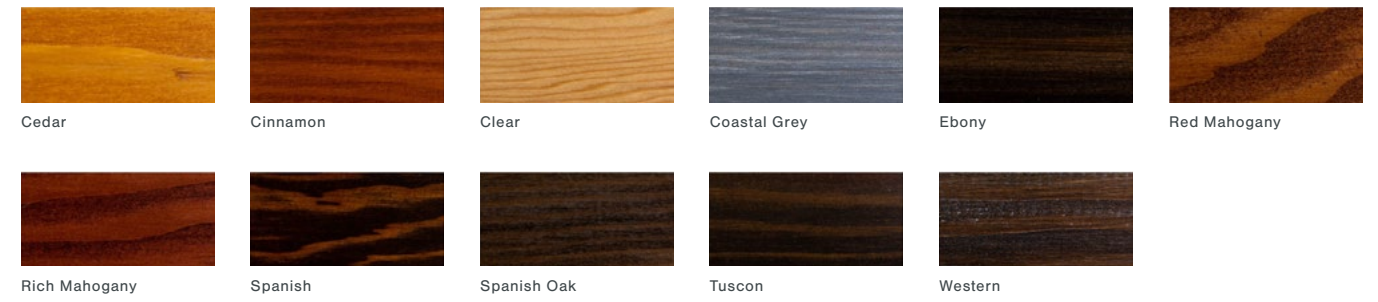

Wirebrushed Tuscon

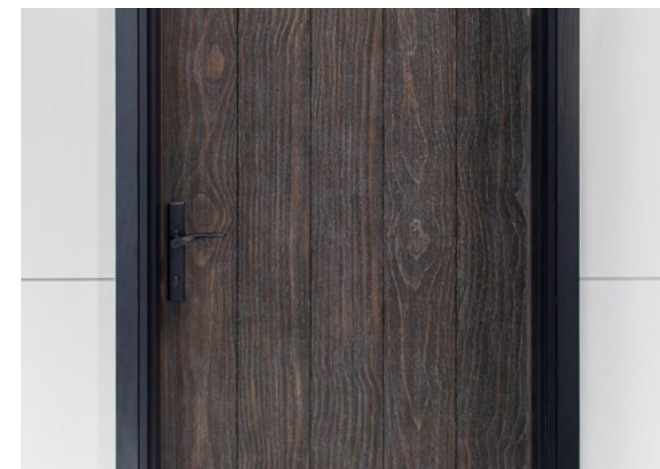
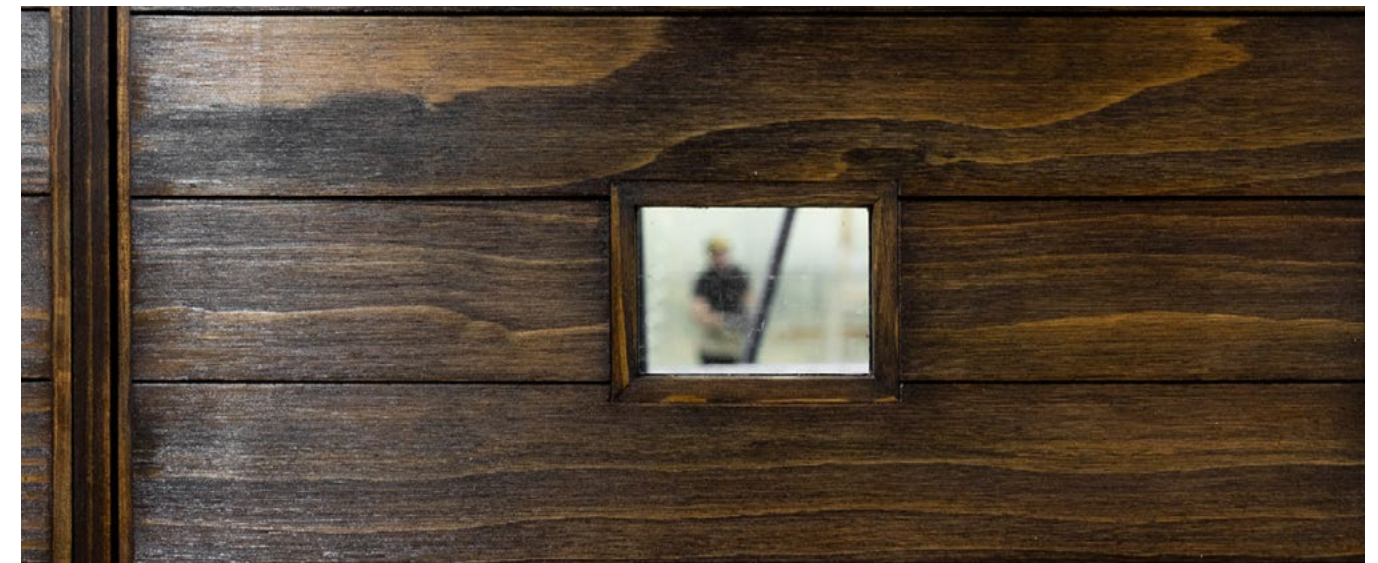

Wirebrushed Western



Wirebrushed Coastal Grey

DURABILITY & VERSATILITY

Versatility is one of the key elements in the Loewen product offering – there are more than ten trillion possible combinations of standard Loewen products.

In addition to this massive standard selection matrix, Loewen products are available in custom shapes, sizes and configurations.

Each Loewen product, whether standard or custom, may be further personalized by choosing the Loewen Cyprium™ Collection or through the use of Simulated Divided Lites, exterior casing options and metal clad paint selection in a variety of colors and finishes. An array of hardware finishes further expand the variety and customization of each window order.

Douglas Fir Durability

Douglas Fir outperforms Hemlock & Pine

Wood Species	Specific Gravity (density) Weight Over Volume	Impact Strength (height of drop causing complete failure) Inch	Compression Strength (parallel to grain) psi	Compression Strength (perpendicular to grain) psi	Hardness (load perpendicular to grain) lbs	Resistance to Decay USFS Grade
Douglas Fir	0.48	31.0	7,230	800	710	Moderate
Mahogany	0.42	Untested	6,460	1,500	830	Slight
Western Hemlock	0.45	23.0	7,200	550	540	Slightly to non-resistant
Ponderosa Pine	0.40	19.0	5,320	580	420	Slightly to non-resistant

Douglas Fir Fastener Retention

This chart shows the force required to remove fasteners

Wood Species	Nail	Screw	Hinge
Douglas Fir	189 lbs	527 lbs	743 lbs
Ponderosa Pine	98 lbs	392 lbs	486 lbs



WINDOW HARDWARE

Selecting a style and finish that reflects your unique taste is a critical part of creating the right look.

But choosing hardware involves more than just appearance – function and operation are essential, which is why Loewen offers a wide range of handles, locking systems and other hardware choices – from the most traditional to the most contemporary. Hardware must also offer intelligent design and flexibility. This is why Loewen provides designs such as the foldaway handle, useful when window coverings fit tight against a window or when access space is limited.

For hard-to-reach windows, optional motorized operators can be activated by a simple wall switch or battery operated remote control.

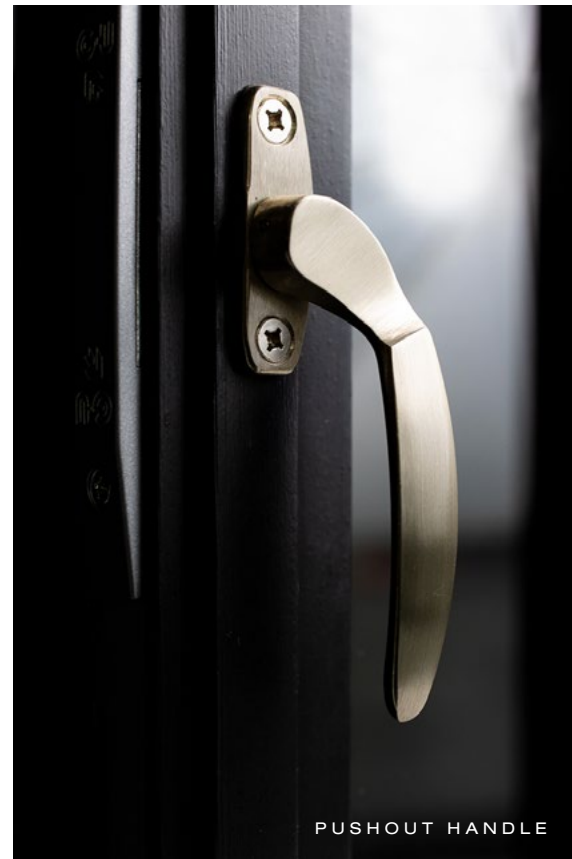

Double Hung

Sash Lock



Rotogear

Contemporary



Tango

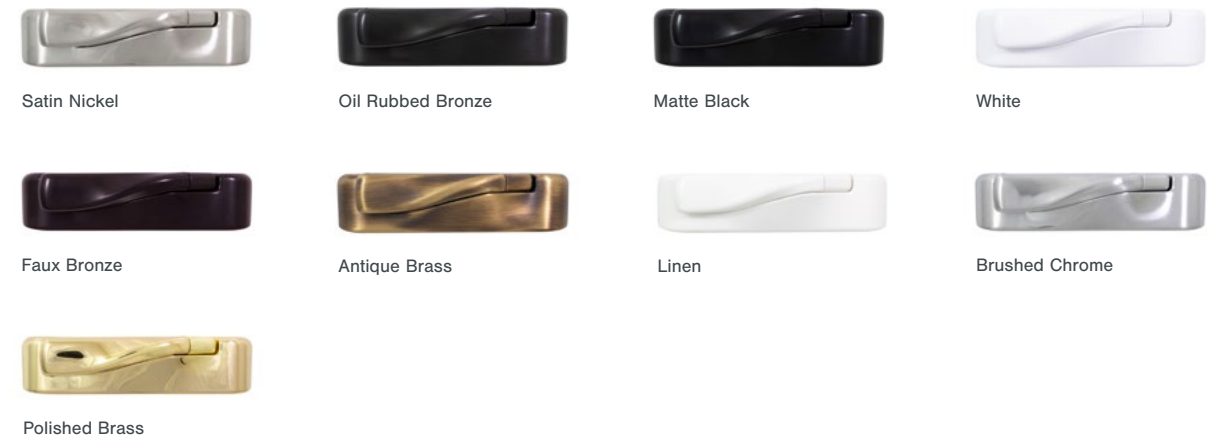

Provence

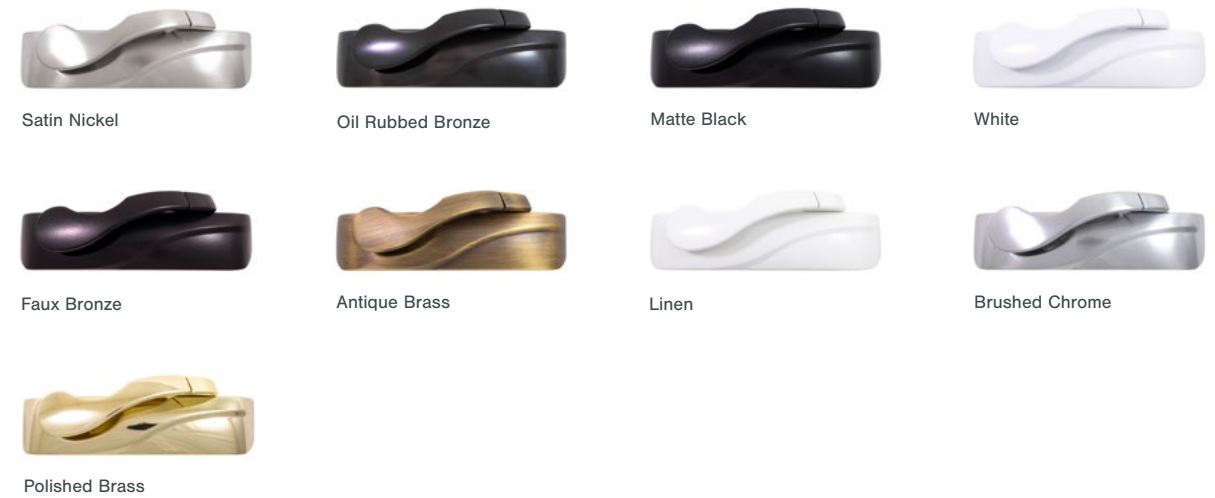

Hardware finish names may only refer to the handle's color, not the handle's actual metal substrate. For example, Loewen carries instances of the Satin Nickel finish on Brass handles.

Pushout

Contemporary



Satin Nickel



Oil Rubbed Bronze



Matte Black



White



Faux Bronze



Linen



Polished Brass

Traditional



Satin Nickel



Oil Rubbed Bronze



Matte Black



White



Faux Bronze



Antique Brass



Linen



Brushed Chrome



Polished Brass



Rustic Bronze



Unlacquered Brass

Hardware finish names may only refer to the handle's color, not the handle's actual metal substrate. For example, Loewen carries instances of the Satin Nickel finish on Brass handles.

DOOR HARDWARE

Loewen doors are available with a wide range of hardware options. We constantly review our hardware selection and new options are regularly added. Consult your Authorized Loewen Dealer for the most current information.

Terrace Door

Dallas



Satin Nickel (PVD*) Matte Black Polished Brass (PVD*) Dark Bronze Metallic Rustic Umber

Verona

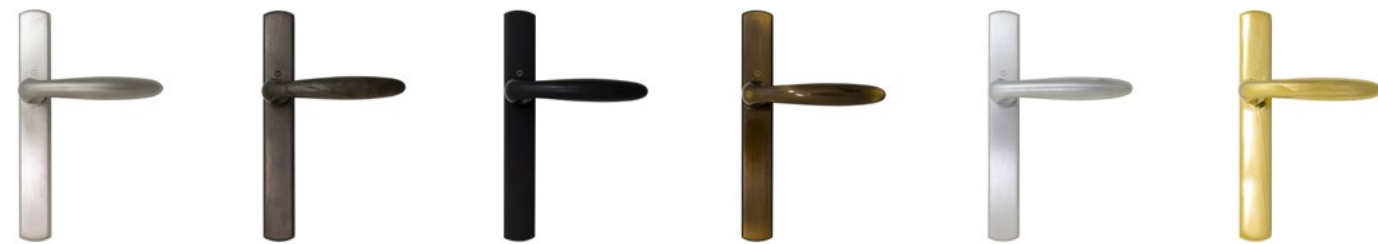

Satin Nickel (PVD*) Oil Rubbed Bronze Matte Black Antique Brass Brushed Chrome (PVD*) Polished Brass (PVD*)

Meran

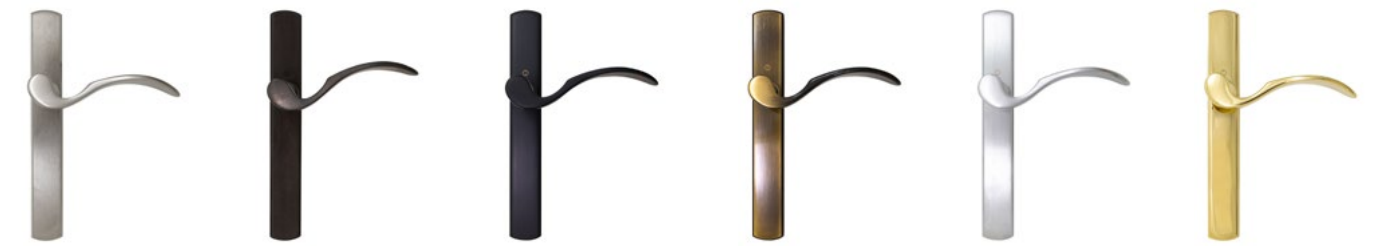

Satin Nickel (PVD*) Oil Rubbed Bronze Matte Black Antique Brass Brushed Chrome (PVD*) Polished Brass (PVD*)

Rodos



Satin Nickel (PVD*) Oil Rubbed Bronze Matte Black Antique Brass Brushed Chrome (PVD*) Polished Brass (PVD*)

Sand Cast Bronze



Churchill Rustic Bronze Shropshire Rustic Bronze

PVD* - Offerings with this designation utilize protective finishes that are appropriate for humid coastal environments.

Hardware finish names may only refer to the handle's color, not the handle's actual metal substrate. For example, Loewen carries instances of the Satin Nickel finish on Brass handles.

MultiSlide & Patio Door

Miami



Satin Nickel (PVD*)



Matte Black



Bronze (PVD*)



Polished Brass (PVD*)

Sand Cast Bronze



Churchill Rustic Bronze

Botticelli



Satin Nickel (PVD*)



Oil Rubbed Bronze



Matte Black



Antique Brass



Bronze (PVD*)



Polished Brass (PVD*)

Fontana



Satin Nickel (PVD*)



Oil Rubbed Bronze



Matte Black



Antique Brass



Bronze (PVD*)



Polished Brass (PVD*)

Flush Handle



Satin Nickel (PVD*)



Matte Black



White



Faux Bronze



Bronze (PVD*)

Hardware finish names may only refer to the handle's color, not the handle's actual metal substrate. For example, Loewen carries instances of the Satin Nickel finish on Brass handles.



LiftSlide Door

Modera



Satin Nickel (PVD*)



Oil Rubbed Bronze



Matte Black



Dark Bronze



Polished Brass (PVD*)

Marcos



Satin Nickel (PVD*)



Oil Rubbed Bronze



Matte Black



Dark Bronze



Polished Brass (PVD*)

Flush Handle



Silicon Bronze Dark



Silicon Bronze Dark Lustre



White Bronze Brushed

Storm & Screen Door

Tampa



Satin Nickel



Oil Rubbed Bronze



Matte Black

Concord



Matte Black



Hardware finish names may only refer to the handle's color, not the handle's actual metal substrate. For example, Loewen carries instances of the Satin Nickel finish on Brass handles.

Storm and Screen Door

GLAZING OPTIONS

Loewen Sealed Units offer ideal solutions for any environment. With countless glazing configurations and LowE coating options, we ensure that you can choose the perfect blend of protection and comfort - no matter where you live.

LowE Window Systems

LowE is a high-performance glazing system that offers great thermal value in a variety of climate zones. They also protect furnishings by limiting much of the damaging ultraviolet radiation that causes fading and related damage. The charts on page A38 show the comparative performance of each Loewen Window System.

LowE Double

Double glazed, with one or more layers of LowE coating and 1/2" (13mm) airspace filled with Argon gas and stainless steel thermal spacer bar.

Loewen standard 1/8" (3 mm) double strength glass offers greater strength and clarity over thinner glass, making our products more insulative, more soundproof, more resistant to impact and considerably more resistant to stresses caused by fluctuations in temperature.

Loewen standard sealed units contain Argon gas and machine applied primary and secondary sealants reducing the chance of seal failure, improving Argon gas retention, and increasing strength.



We pioneered True Triple Glazing in the 1970's, which is a testament to our approach on innovation. For premium energy performance, we've made triple glazing available across our entire product line.

True Triple Sealed Units with LowE surface coatings for maximum performance

Triple glazed, with multiple layers of LowE coatings and two 1/2" airspaces filled with Argon gas and stainless steel thermal spacer bars. Our LowE Triple features full 1/2" airspaces to maximize energy efficiency unlike other window systems that use lesser performing narrower airspaces.

Loewen standard 1/8" (3mm) double strength glass provides greater strength and clarity over thinner glass, making our products more insulative, more soundproof, more resistant to impact and considerably more resistant to stresses caused by fluctuations in temperature

Loewen standard sealed units contain Argon gas in all airspaces and machine applied primary and secondary sealants, reducing the chance of seal failure, improving Argon gas retention and increasing strength

Venting channel built into the sash helps dissipate should condensation or moisture occur

Stainless steel spacer bar is less conductive than aluminum and structurally superior to silicone foam type spacers

Sash cladding does not touch the glass which reduces the opportunity for thermal conduction

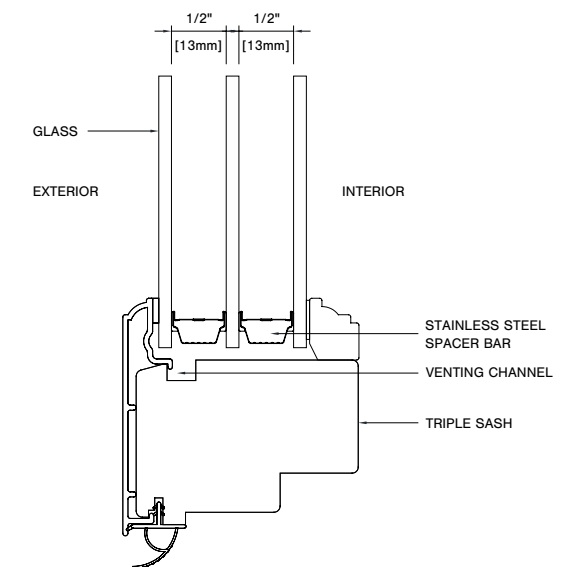

LowE Compared With Clear Double & Triple Pane Glass Units

U-VALUE*

This chart illustrates the resistance of heat transfer through the glass. Lower U-Value indicates greater insulating capabilities. U-Value measured at center of glass.

SOLAR HEAT GAIN (SHGC)*

This chart measures the ratio of solar heat gain through a glazing system compared to an unobstructed opening.

UV TRANSMITTANCE*

This chart measures the percentage of ultraviolet radiated wavelengths allowed to be transmitted through the glazing system.

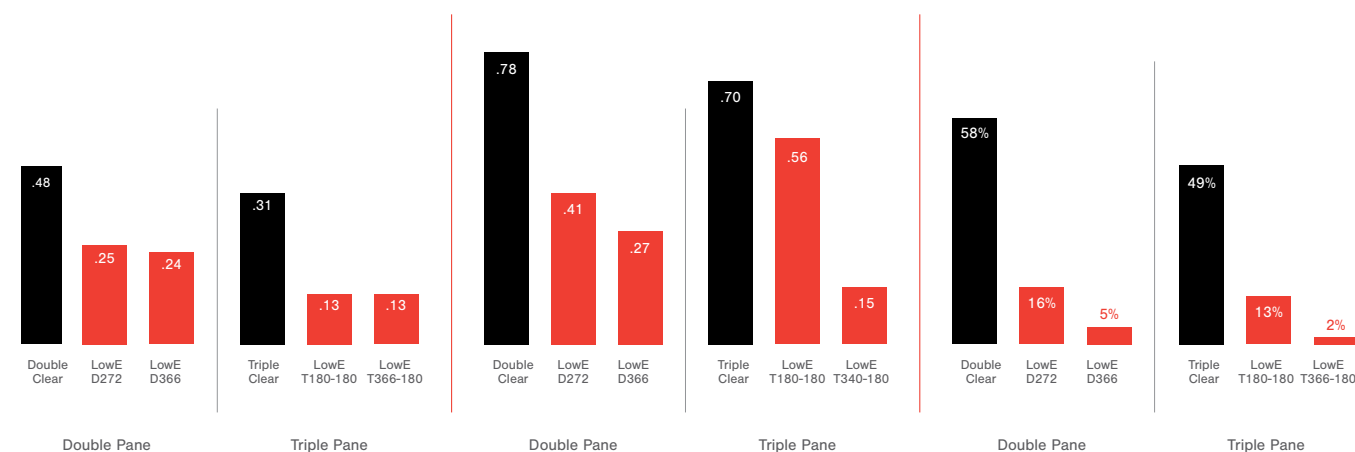

*Ashrae calculated values Window 5.2 | 1/2" airspace (13 mm) | Does not apply to sealed units with capillary tubes installed

Note: Information in these charts compares the center of glass performance levels of the sealed unit only when manufactured with different glazing options. They are not representative of overall window performance, which depends on many factors including grille options, such as simulated divided lites, grilles between glass, product size and configuration. This information cannot be used to calculate energy performance, to determine resistance to condensation or to develop assumptions about suitability for use or compliance with energy codes. For overall performance of specific windows or doors, refer to "NFRC U-factor and SHGC/VT" information.

LowE Coating Options

We offer as many glazing configurations and LowE coatings as there are climates so our window performance can be built to provide comfort in any environment.

LowE – 366 Ultimate Performance

Highest level of year-round comfort for every climate

Better insulator (low u-value) and solar heat blockage (low SHGC)

Three layers of silver (LowE 366)

LowE – 180 Passive Solar Gain

Ideal for passive solar applications

Good insulator (low u-value) and high solar heat gain

One layer of silver (LowE 180)

LowE – 340 Ultimate Solar Control

Greatly reduces oppressive solar heat gain & glare

Best insulator (low u-value)

Three layers of silver (LowE 340)

LowE – i89 Roomside LowE

Indoor lite, surface #4 (double) or #6 (triple) reflecting more heat back into the room

Enhanced insulation (lowers u-value)

Iridium Tin Oxide coating (LowE i89)

LowE – 272 All-Climate

Year-round, well balanced performance and comfort

Better insulator (low u-value) and moderate solar heat blockage

Two layers of silver (LowE 272)

Glazing Fabrication

TINTED GLAZING

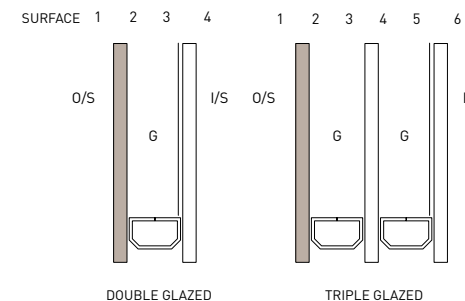

LOW E
TINTED
G = ARGON GAS

LowE® Glazing Fabrication

STANDARD GLAZING

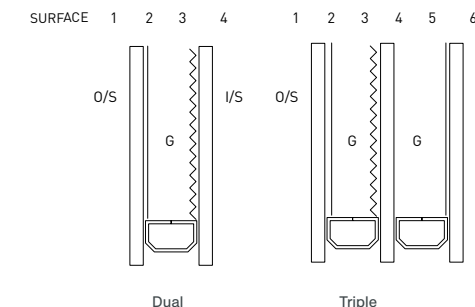

LOW E
ETCHED, OPAQUE, OBSCURE
G = ARGON GAS

SPECIALTY GLAZING

Neat+® Glass or Preserve™ Protective Film Added Value Solutions

Neat+® Glass is an ultra smooth surface made from silicon dioxide that harnesses UV rays to loosen dirt. Neat+® Glass helps leave windows spotless with a quick rinse of water and preserves their cleanliness longer. Neat+® Glass is offered with Preserve™ as standard to protect the Neat® surface.

Loewen windows and doors may also be equipped with added value solutions, such as Preserve™ protective film. Preserve™ is made from a low-density polyethylene and water-based adhesive that reduces masking and cleanup costs for painting and staining. Available for the exterior and interior window and door glass surfaces, Preserve™ is quickly and easily removed

Tranquility Solutions for Traffic & Other Urban Noise

Loewen's heavy frames, thick glass and superior fit and finish result in above-average sound attenuation.

Tranquility® Glazing Systems Greatly Reduce Sound Transmission.

Tranquility® Glazing Systems consist of a 1/4" (6 mm) glass on the exterior, a 13/16" (21 mm) Argon filled space, and a 9/32" (7 mm) laminate pane of glass on the interior.

Operating casement units test out at STC40 (no storm panel is required to achieve this rating). Visit www.loewen.com for details.

Laminated glass used in the sealed unit provides increased security and helps to filter out damaging ultraviolet rays.

Tranquility® Sound Transmission Class (STC)

Using a single number, the STC rating identifies the sound transmission reduction of a glazing unit over a range of frequencies.

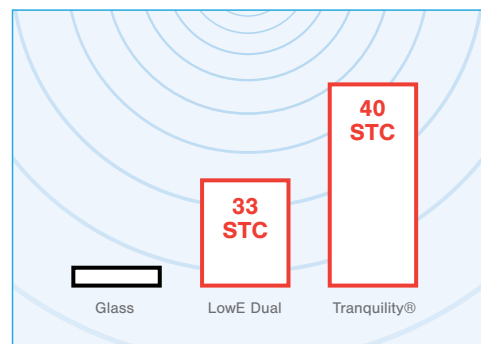

Tranquility® available on product configured for triple pane only.

Tranquility® Glazing

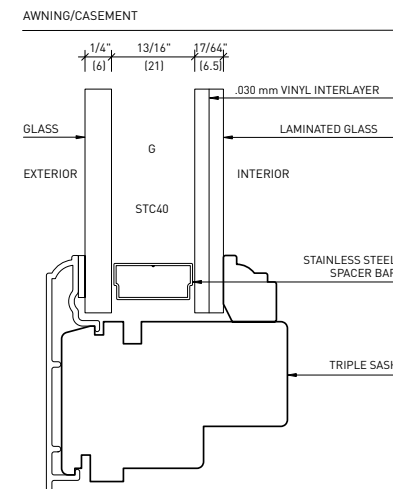

Additional options include a wide variety of novelty glass treatments. These images are a sample of the offerings that can be added to selected Loewen windows and doors. Please contact your local dealer for the full range of options and applications.

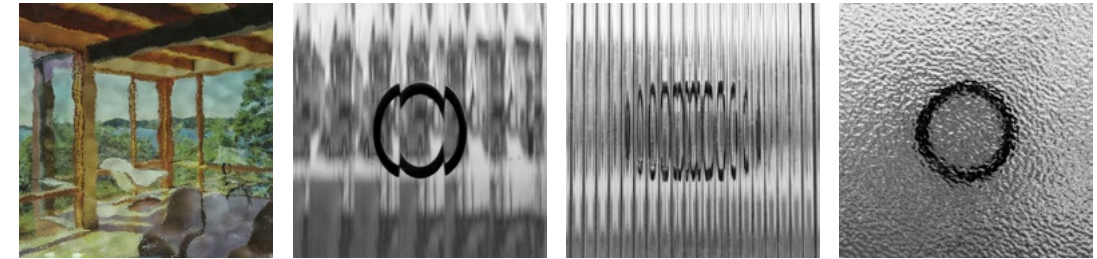

Aqualite English Reed Narrow Reed Pattern #62

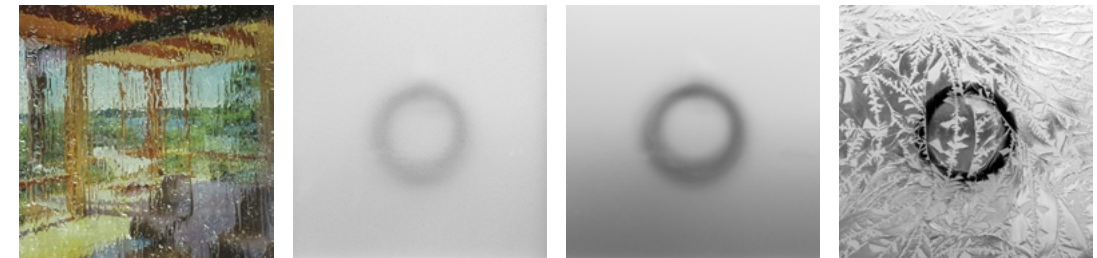

Rain Sandblast Satin Etch Single Glue Chip



Narrow Reed

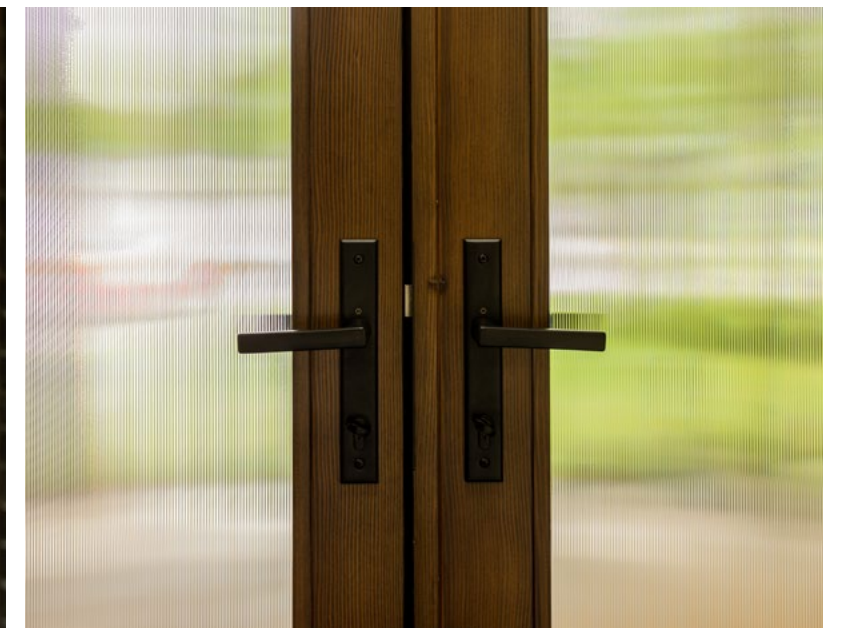

Narrow Reed

DIVIDED LITES AND GRILLES

Simulated Divided Lite (SDL) bars add a distinctive design feature to full-size panes of glass. Wood or metal bars securely bonded to the outer surfaces of the sealed glass unit simulate the appearance of traditional true divided lites.

Available with straight or radius bars.

Additional airspace bars (between the glass) complete a convincing reproduction of a multi-paned window or door. Our spacer bars function among the best in the industry and provide an intriguing aesthetic appearance in stainless steel or black color options. Wide shadow bars fill more of the airspace replicating the look of True Divided Lites. Narrow shadow bars also provide a similar appearance while allowing for improved sealed unit performance.

Exterior Bar Options

	Ogee	Putty
Cross Section		
5/8" [16]		
3/4" [19]		
7/8" [22]		
1-1/8" [30]		
2" [51]		

Simulated Divided Lite (SDL) Standard Patterns

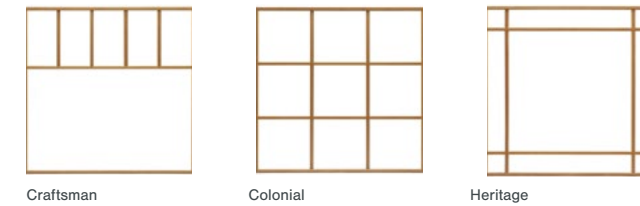

Craftsman Colonial Heritage

Extended Half Round

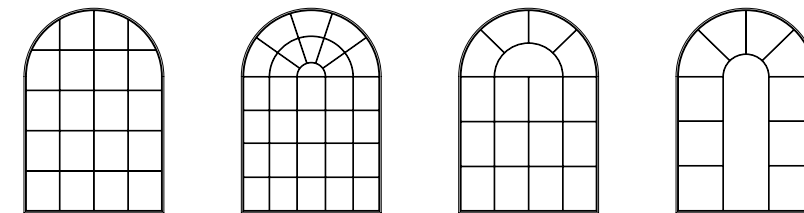

STYLE GR1 STYLE GR2 STYLE GR3 STYLE GR4

Extended Half Ellipse

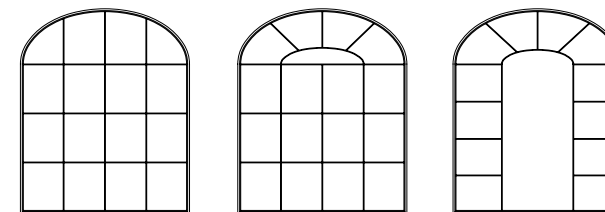

STYLE GR5 STYLE GR6 STYLE GR7

Extended Quarter Round

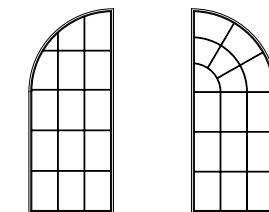

STYLE GR8 STYLE GR9

Extended Full Chord

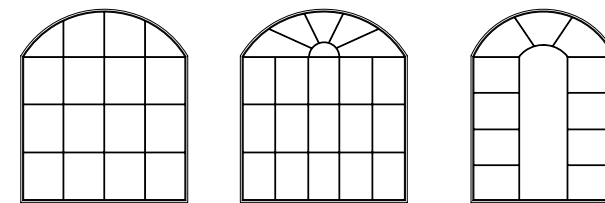

STYLE GR10 STYLE GR11 STYLE GR12

Full Round

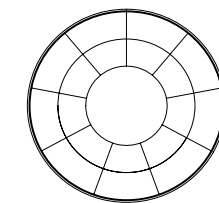

STYLE GR13

Sunburst

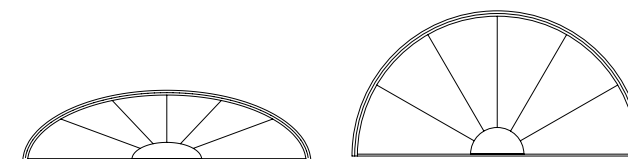

STYLE GR14 STYLE GR15

Oval

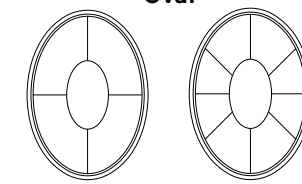









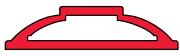



















STYLE GR16 STYLE GR17

Note: Number of grille bars and spacing is determined by the size of the unit. Grille type may not be available in all units. Custom patterns available for approval.

Information is subject to change without notice. | CAD download and installation instructions: www.loewen.com

Awning & Casement Units Types of Simulated Divided Lite

















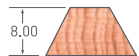



Application	Available SDL	5/8" [16mm]	3/4" [19mm]	7/8" [22mm]	1-1/8" [30mm]	2" [50mm]
MC Exterior	Ogee					
Interior	Ogee					
MC Exterior	Putty					
NC Exterior / Interior	Putty					
Interior	Square					
Interior	Impact Ogee					
NC Exterior	Ogee					

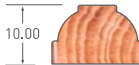

Note: MC = Metal Clad, NC = Non Clad

Information is subject to change without notice. | CAD download and installation instructions: www.loewen.com

Double/Single Hung Units Types of Simulated Divided Lite













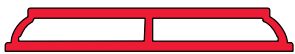



















Application	Available SDL	5/8" [16mm]	3/4" [19mm]	7/8" [22mm]	1-1/8" [30mm]	2" [50mm]
MC Exterior	Ogee					
Interior	Ogee					
MC Exterior	Putty					
NC Exterior / Interior	Putty					
Interior	Square					
Interior	Impact Ogee					
NC Exterior	Ogee					

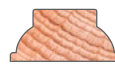

Note: MC = Metal Clad, NC = Non Clad

Information is subject to change without notice. | CAD download and installation instructions: www.loewen.com

Picture Units
Types of Simulated Divided Lite





































Application	Available SDL	5/8" [16mm]	3/4" [19mm]	7/8" [22mm]	1-1/8" [30mm]	2" [50mm]
MC Exterior	Ogee					
Interior	Ogee					
MC Exterior	Putty					
NC Exterior / Interior	Putty					
Interior	Square					
Interior	Impact Ogee					
NC Exterior	Ogee					



Note: MC = Metal Clad, NC = Non Clad

Information is subject to change without notice. | CAD download and installation instructions: www.loewen.com

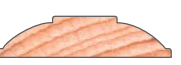
Patio Door Unit
Types of Simulated Divided Lite

Application	Available SDL	5/8" [16mm]	3/4" [19mm]	7/8" [22mm]	1-1/8" [30mm]	2" [50mm]
MC Exterior	Ogee					
Interior	Ogee					
MC Exterior	Putty					
NC Exterior / Interior	Putty					
Interior	Square					
Interior	Impact Ogee [MP]					
Interior	Impact Ogee [MP]					
NC Exterior	Ogee					



Note: MC = Metal Clad, NC = Non Clad

Information is subject to change without notice. | CAD download and installation instructions: www.loewen.com

Terrace/French & Bifold Door Unit Types of Simulated Divided Lite

Application	Available SDL	5/8" [16mm]	3/4" [19mm]	7/8" [22mm]	1-1/8" [30mm]	2" [50mm]
MC Exterior	Ogee					
Interior	Ogee					
MC Exterior	Putty					
NC Exterior / Interior	Putty					
Interior	Square					
Interior	Impact Ogee [MP]					
Interior	Impact Ogee [MP]					
NC Exterior	Ogee					

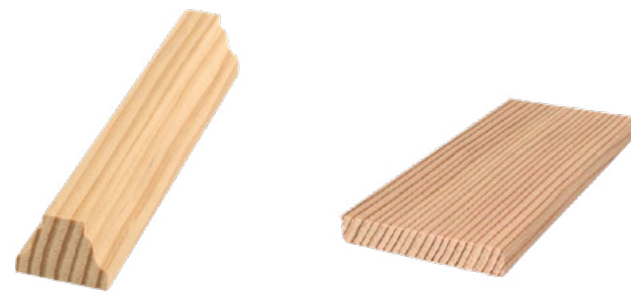

Note: MC = Metal Clad, NC = Non Clad

Information is subject to change without notice. | CAD download and installation instructions: www.loewen.com

Casing, Jamb & Opening Definitions

Head & Sill Detail

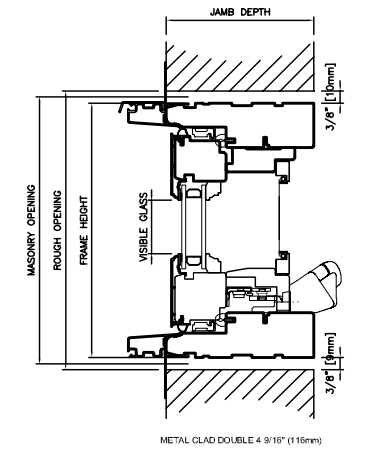

METAL CLAD DOUBLE 4 9/16" (116mm)

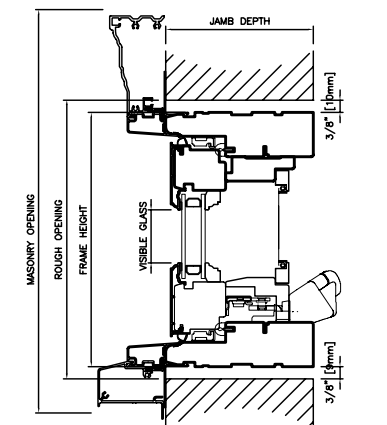

METAL CLAD DOUBLE 4 9/16" (116mm)
with ADAMS CASING & BC NOSING

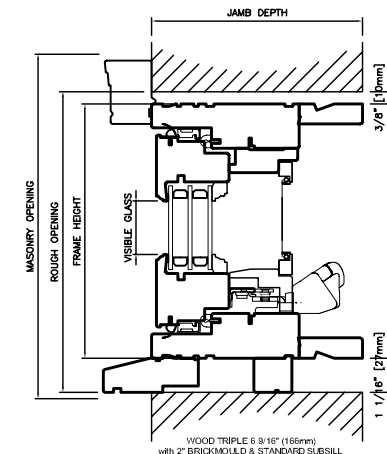

WOOD TRIPLE 6 9/16" (166mm)
with 2" BRICKMOULD & STANDARD SUBSILL

Plan View

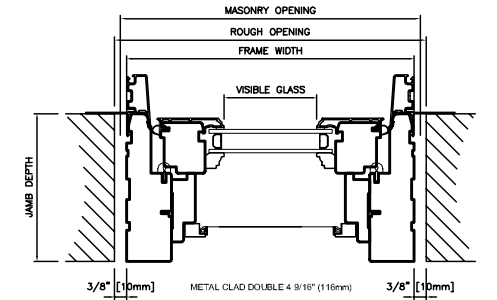

METAL CLAD DOUBLE 4 9/16" (116mm)

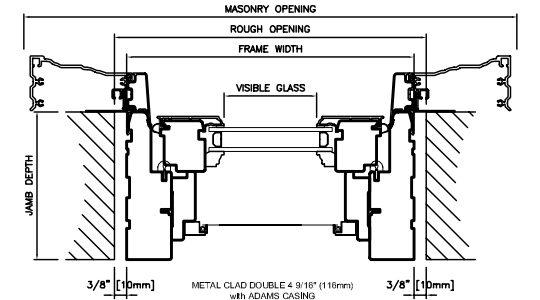



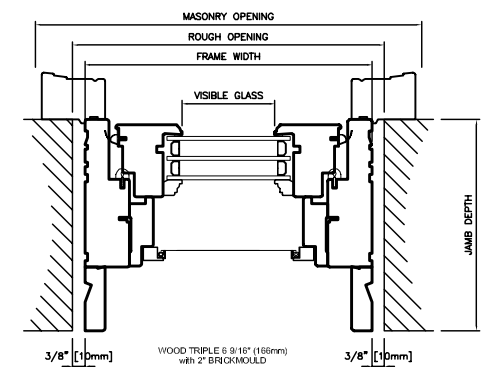







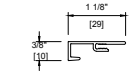
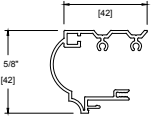
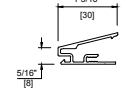
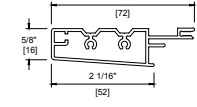



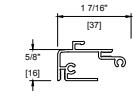
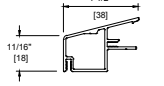
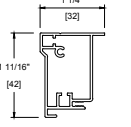
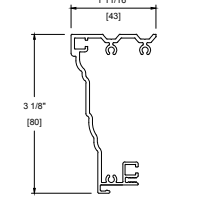

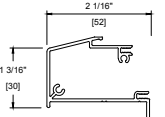
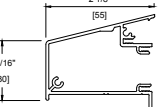
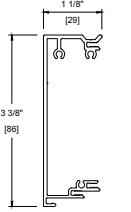
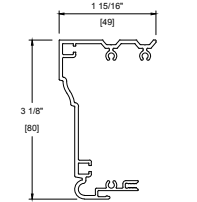

METAL CLAD DOUBLE 4 9/16" (116mm)
with ADAMS CASING

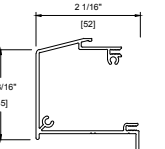
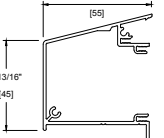
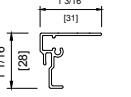

WOOD TRIPLE 6 9/16" (166mm)
with 2" BRICKMOULD

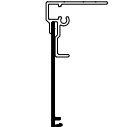
Information is subject to change without notice. | CAD download and installation instructions: www.loewen.com

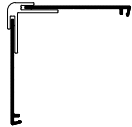
Metal Clad Casing, Sill Nose & Accessories

				
Direct Mull Cover	Kerf Casing	Nose & Cove Casing	Double Hung Multi-Lite Sill Nose	2" Clad Frame Extension
				
1/4" Spread Mull Cover				
				
1" Spread Mull Cover				
				
1 1/2" Spread Mull Cover	Standard Sill Nose	Double Hung Standard Sill Nose	2" Brickmould	Adams Casing
				
2" Spread Mull Cover				
				
2 1/2" Spread Mull Cover				
				
3" Spread Mull Cover	BC Sill Nose	Double Hung BC Sill Nose	3 1/2" Flat Casing	Williamsburg Casing
				
4" Spread Mull Cover				
				
6" Spread Mull Cover				
				
	Heritage Sill Nose	Double Hung Heritage Sill Nose	Adjustable Brickmould	H-Clip
				
				L-Clip
				
1" Frame Expander				
				
2" Frame Expander	Add frame expander for custom height brickmould.	Add frame expander for custom mull cover.	Add frame expander for custom corner cover.	
				
3" Frame Expander				
				
4" Frame Expander				

Note: • Other jamb widths available.

Information is subject to change without notice. | CAD download and installation instructions: www.loewen.com

Contemporary Frame Cladding

Head & Sill Detail

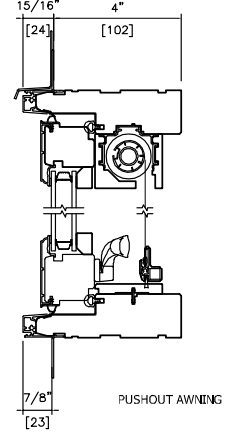
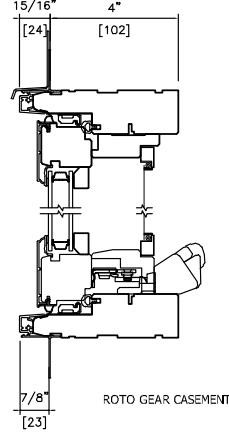
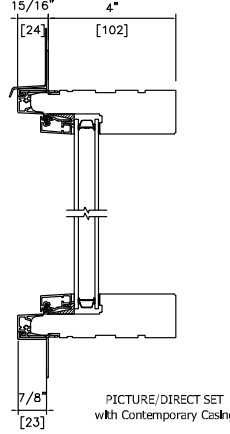
		
PUSHOUT AWNING	ROTO GEAR CASEMENT	PICTURE/DIRECT SET with Contemporary Casing

Head & Sill Detail

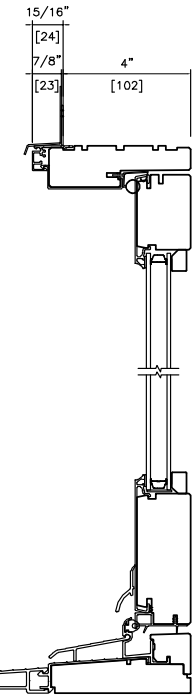
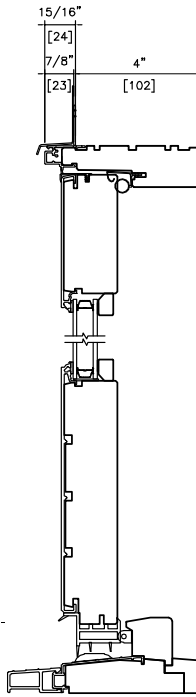
	
INSWING TERRACE/FRENCH TERRACE - NARROW STILE	OUTSWING TERRACE/FRENCH TERRACE - STANDARD STILE

Casing

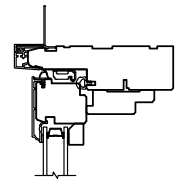
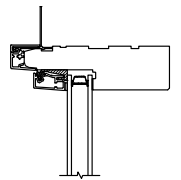
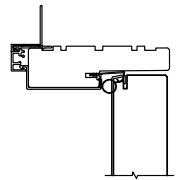
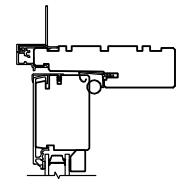
			
AWNING/CASEMENT	PICTURE/DIRECT SET	INSWING TERRACE/FRENCH TERRACE	OUTSWING TERRACE/FRENCH TERRACE -

Information is subject to change without notice. | CAD download and installation instructions: www.loewen.com

Wood Exterior Casing & Subsill Options

Wood Casings

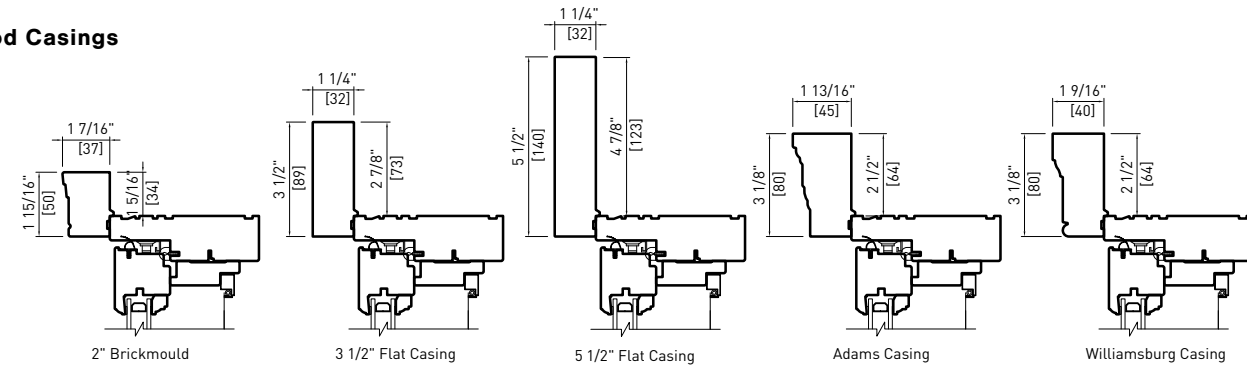

Wood Flat Casings - Elevation View

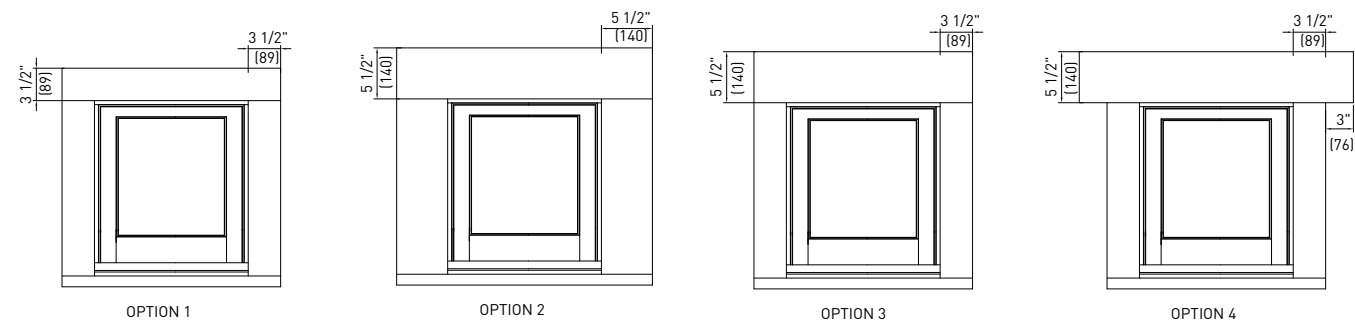

Wood Subsills

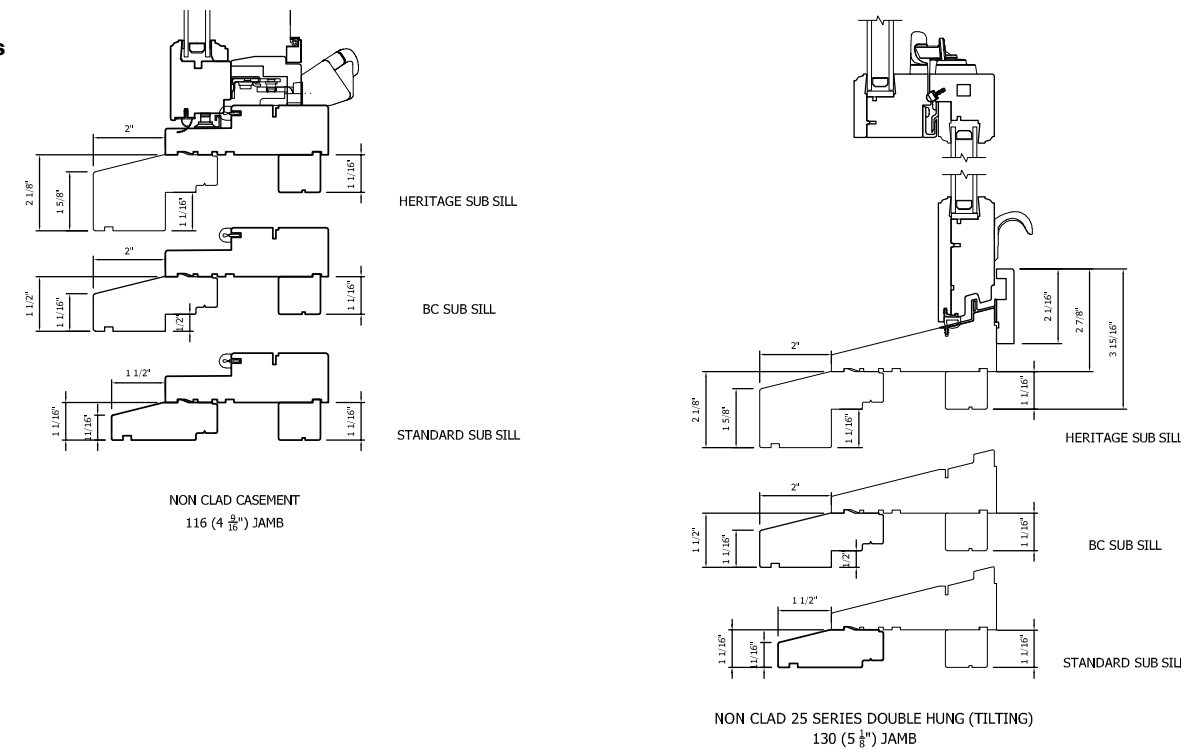

Note: • Other jamb widths available.

Information is subject to change without notice. | CAD download and installation instructions: www.loewen.com

Masonry Opening Metal Clad

Casing Options

Frame Cladding Only.
Add 3/16" (5mm) to
Frame Dimensions at
Head & Sides.

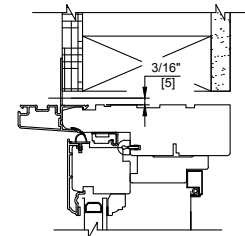

Contemporary Casing.
Add 3/8" (10mm) to
Frame Dimensions at
Head & Sides.

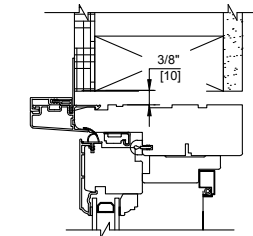

2" Clad Frame Extension.
Add 3/8" (10mm) to
Frame Dimensions at
Head & Sides.

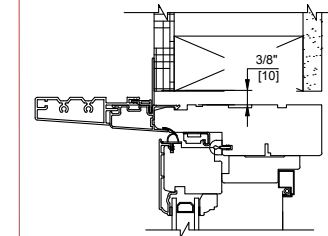

2" Brickmould.
Add 1 11/16" (43mm) to
Frame Dimensions at
Head & Sides.

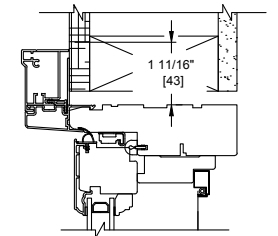

Sill Nose Options

Frame Cladding Only.
Add 3/16" (5mm) to
Frame Dimension at Sill.

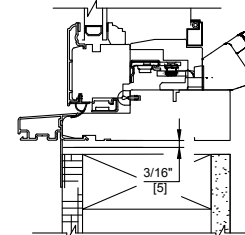

Contemporary Casing.
Add 3/8" (10mm) to
Frame Dimension at Sill.

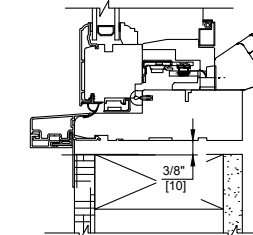

2" Clad Frame Extension.
Add 3/8" (10mm) to
Frame Dimension at Sill.

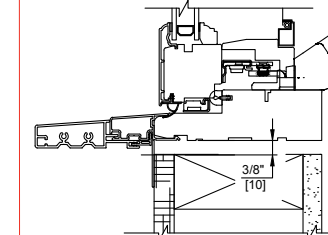

Standard Sill Nose.
Add 13/16" (21mm) to
Frame Dimension at Sill.

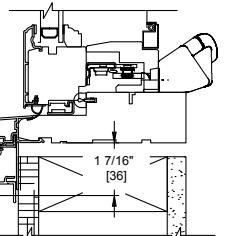
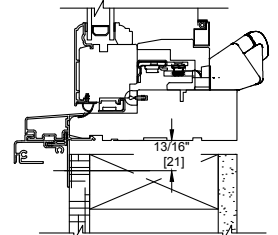

BC Sill Nose.
Add 1 7/16" (36mm) to
Frame Dimension at Sill.

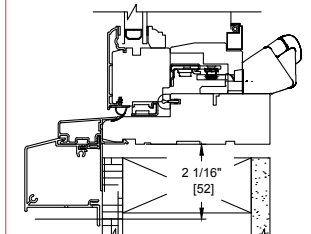

Heritage Sill Nose.
Add 2 1/16" (52mm) to
Frame Dimension at Sill.

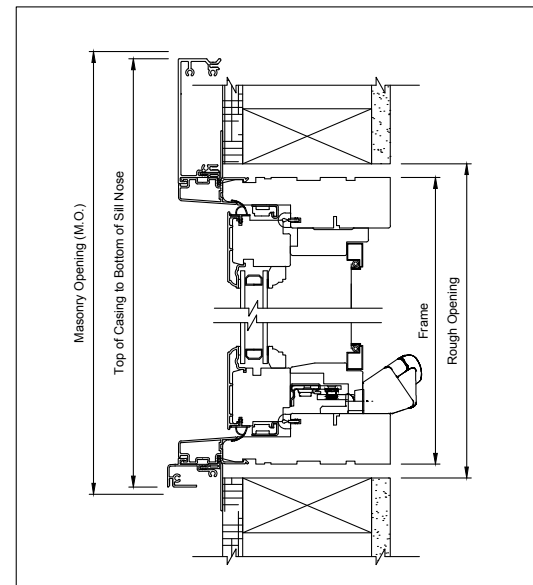

Note: • Other jamb widths available.

Information is subject to change without notice. | CAD download and installation instructions: www.loewen.com

Masonry Opening Metal Clad

Casing Options

3 1/2" Flat Casing.
Add 3 7/16" (87mm) to
Frame Dimensions at
Head & Sides.

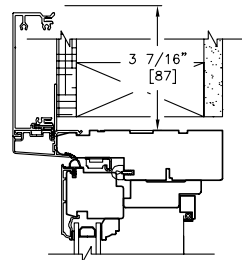

Nose & Cove Casing.
Add 1 9/16" (40mm) to
Frame Dimensions at
Head & Sides.

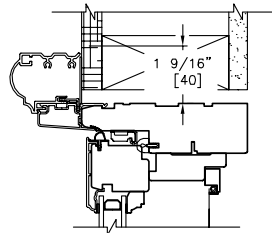

Adams Casing.
Add 3 3/16" (81mm) to
Frame Dimensions at
Head & Sides.

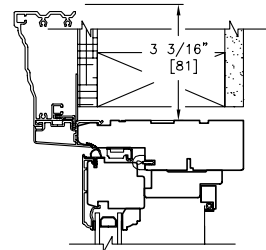

Williamsburg Casing.
Add 3 3/16" (81mm) to
Frame Dimensions at
Head & Sides.

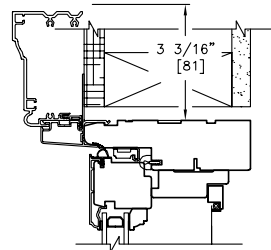

Sill Nose Options

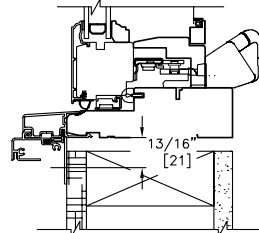

Standard Sill Nose.
Add 13/16" (21mm) to
Frame Dimension at Sill.

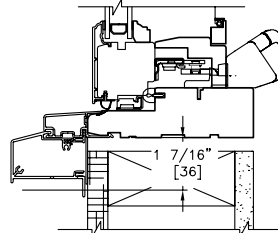

BC Sill Nose.
Add 1 7/16" (36mm) to
Frame Dimension at Sill.

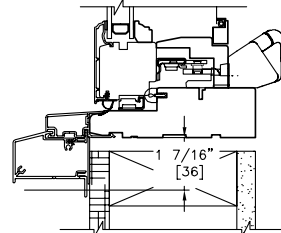

BC Sill Nose.
Add 1 7/16" (36mm) to
Frame Dimension at Sill.

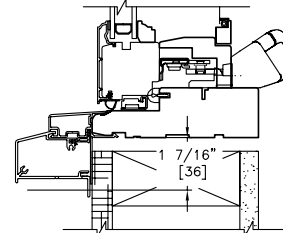

BC Sill Nose.
Add 1 7/16" (36mm) to
Frame Dimension at Sill.

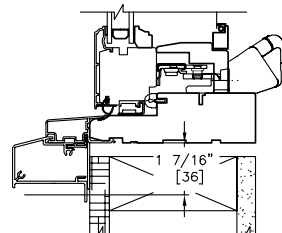

BC Sill Nose.
Add 1 7/16" (36mm) to
Frame Dimension at Sill.

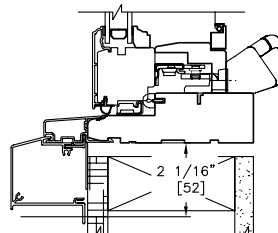

Heritage Sill Nose.
Add 2 1/16" (52mm) to
Frame Dimension at Sill.

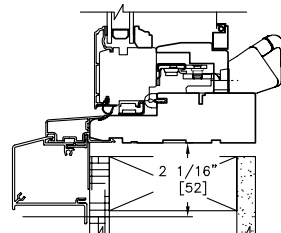

Heritage Sill Nose.
Add 2 1/16" (52mm) to
Frame Dimension at Sill.

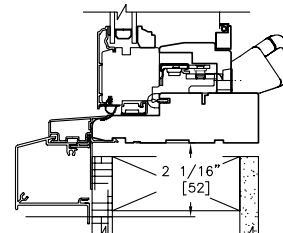

Heritage Sill Nose.
Add 2 1/16" (52mm) to
Frame Dimension at Sill.

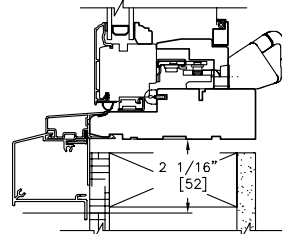

Heritage Sill Nose.
Add 2 1/16" (52mm) to
Frame Dimension at Sill.

EXAMPLE #1: CA1 7515 with 2" Brickmould & Standard sill nose.
Frame dimensions, 29 1/2" (750mm) x 59 1/16" (1500mm).
Masonry width = 29 1/2" (750mm) + [1 11/16" (43mm) x 2] = 32 7/8" (836mm)
Masonry height = 59 1/16" (1500mm) + 1 11/16" (43mm) + 13/16" (21mm) = 61 9/16" (1564mm)

EXAMPLE #2: CA1 0918 with Adams casing & BC sill nose.
Frame dimensions, 35 7/16" (900mm) x 70 7/8" (1800mm).
Masonry width = 35 7/16" (900mm) + [3 3/16" (81mm) x 2] = 41 13/16" (1062mm)
Masonry height = 70 7/8" (1800mm) + 3 3/16" (81mm) + 1 7/16" (36mm) = 75 1/2" (1917mm)

Note: • Other jamb widths available.

Information is subject to change without notice. | CAD download and installation instructions: www.loewen.com

Masonry Opening Metal Clad - Double Hung

Casing Options

Frame Cladding Only.
Add 3/16" (5mm) to
Frame Dimensions at
Head & Sides.

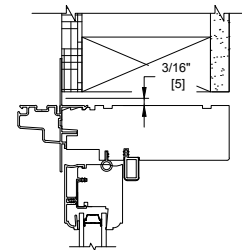

Frame Cladding Only.
Add 3/16" (5mm) to
Frame Dimensions at
Head & Sides.

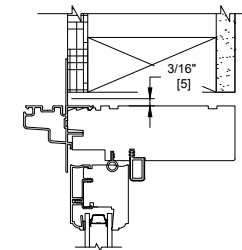

2" Brickmould.
Add 1 11/16" (43mm) to
Frame Dimensions at
Head & Sides.

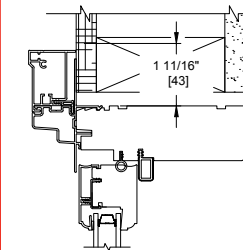

3 1/2" Flat Casing.
Add 3 7/16" (87mm) to
Frame Dimensions at
Head & Sides.

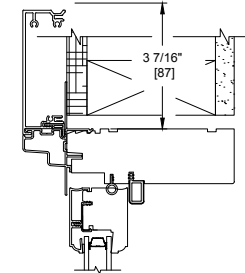

Sill Nose Options

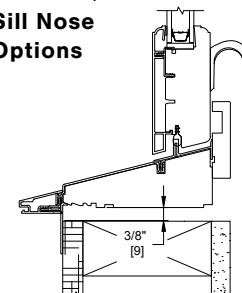

Multi Lite Sill Nose.
Add 3/8" (9mm) to Frame
Dimension at Sill.

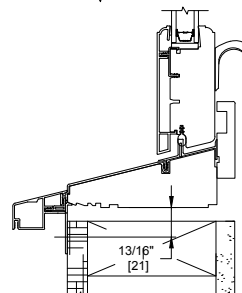

Standard Sill Nose.
Add 13/16" (21mm) to
Frame Dimension at Sill.

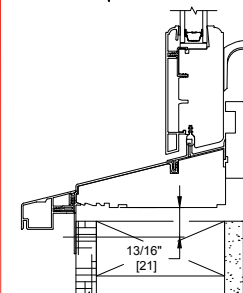

Standard Sill Nose.
Add 13/16" (21mm) to
Frame Dimension at Sill.

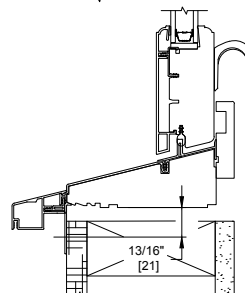

Standard Sill Nose.
Add 13/16" (21mm) to
Frame Dimension at Sill.

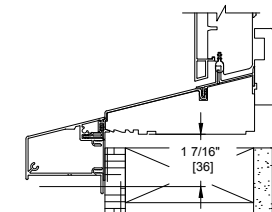
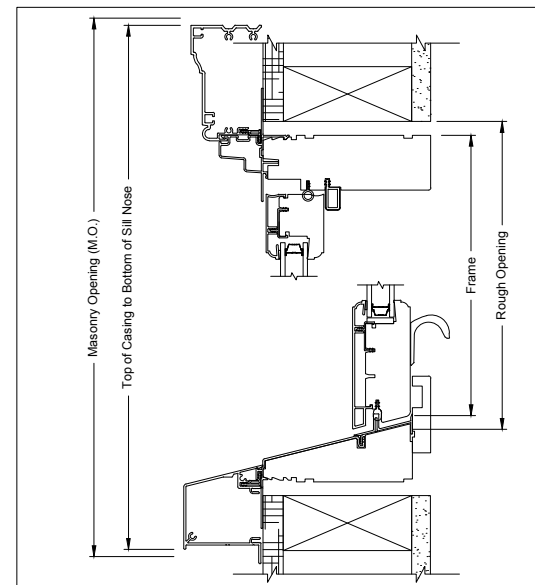

BC Sill Nose.
Add 1 7/16" (36mm) to
Frame Dimension at Sill.

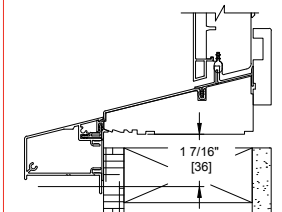

BC Sill Nose.
Add 1 7/16" (36mm) to
Frame Dimension at Sill.

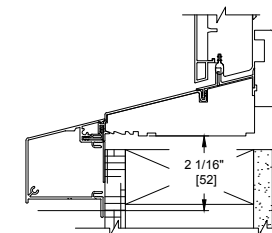

Heritage Sill Nose.
Add 2 1/16" (52mm) to
Frame Dimension at Sill.

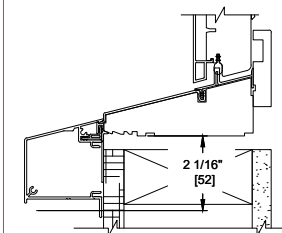

Heritage Sill Nose.
Add 2 1/16" (52mm) to
Frame Dimension at Sill.

Note: • Other jamb widths available.

Information is subject to change without notice. | CAD download and installation instructions: www.loewen.com

Masonry Opening Metal Clad - Double Hung

Casing Options

Nose & Cove Casing.
Add 1 9/16" (40mm) to
Frame Dimensions at
Head & Sides.

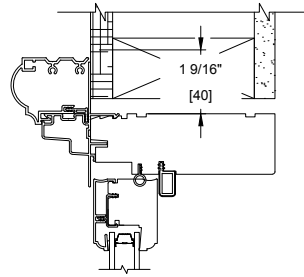

Adams Casing.
Add 3 3/16" (81mm) to
Frame Dimensions at
Head & Sides.

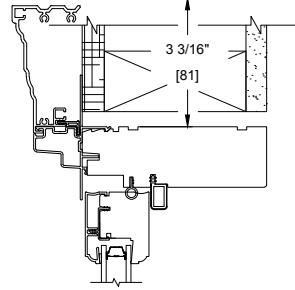

Williamsburg Casing.
Add 3 3/16" (81mm) to
Frame Dimensions at
Head & Sides.

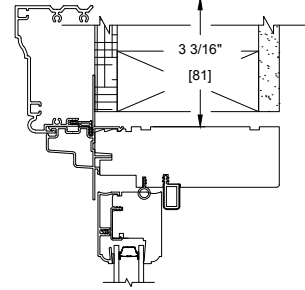

Sill Nose Options

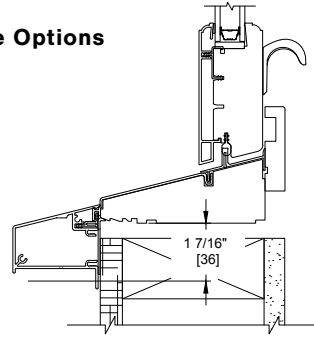

BC Sill Nose.
Add 1 7/16" (36mm) to
Frame Dimension at Sill.

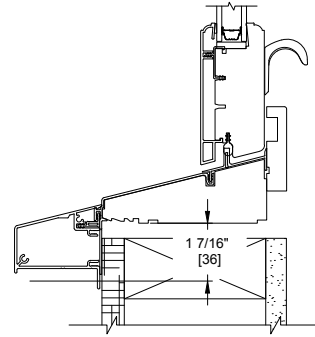

BC Sill Nose.
Add 1 7/16" (36mm) to
Frame Dimension at Sill.

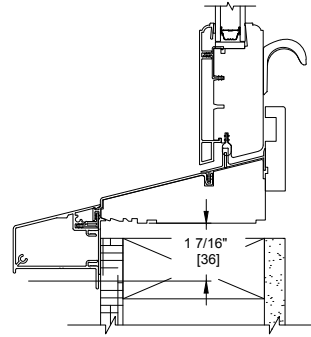

BC Sill Nose.
Add 1 7/16" (36mm) to
Frame Dimension at Sill.

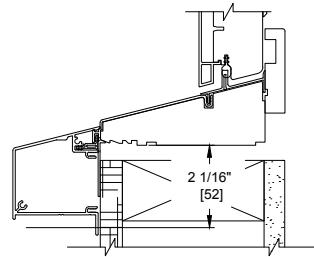

Heritage Sill Nose.
Add 2 1/16" (52mm) to
Frame Dimension at Sill.

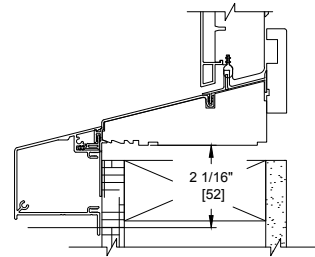

Heritage Sill Nose.
Add 2 1/16" (52mm) to
Frame Dimension at Sill.

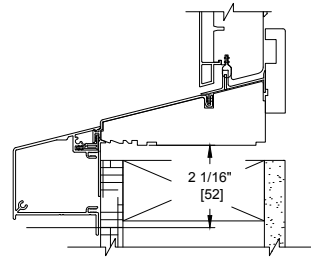

Heritage Sill Nose.
Add 2 1/16" (52mm) to
Frame Dimension at Sill.

EXAMPLE #1: DH1 2828 with Frame Cladding Only & Standard sill nose.

Frame dimensions, 33 1/16" (859mm) x 64 1/4" (1632mm).

Masonry width = 33 13/16" (859mm) + [3/16" (5mm) x 2] = 34 3/16" (869mm)

Masonry height = 64 1/4" (1632mm) + 3/16" (5mm) + 13/16" (21mm) = 65 1/4" (1658mm)

EXAMPLE #2: DH1 3238 with Nose & Cove casing & Heritage sill nose.

Frame dimensions, 37 13/16" (961mm) x 84 1/4" (2140mm).

Masonry width = 37 13/16" (961mm) + [1 9/16" (40mm) x 2] = 40 15/16" (1041mm)

Masonry height = 84 1/4" (2140mm) + 1 9/16" (40mm) + 2 1/16" (52mm) = 87 7/8" (2232mm)

Note: • Other jamb widths available.

Information is subject to change without notice. | CAD download and installation instructions: www.loewen.com

Masonry Opening Wood Exterior

Casing Options

2" BRICKMOULD.
ADD 1 9/16" (39 mm) TO FRAME
DIMENSIONS AT HEAD & SIDES.

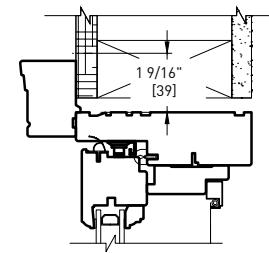

3 1/2" FLAT CASING.
ADD 3 3/16" (78 mm) TO FRAME
DIMENSIONS AT HEAD & SIDES.

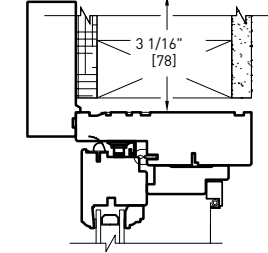

5 1/2" FLAT CASING.
ADD 5 1/16" (129 mm)
TO FRAME DIMENSIONS
AT HEAD & SIDES.

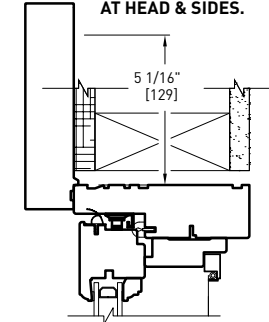

Sill Nose Options

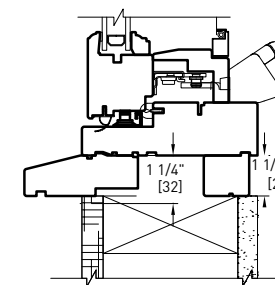

STANDARD SUB SILL.
ADD 1 1/4" (32 mm) TO
FRAME DIMENSION AT SILL.

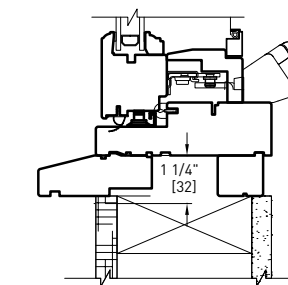

STANDARD SUB SILL.
ADD 1 1/4" (32 mm) TO
FRAME DIMENSION AT SILL.

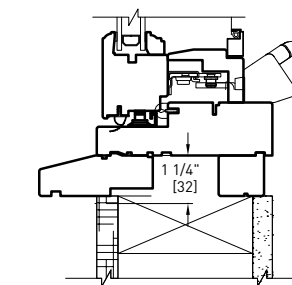

STANDARD SUB SILL.
ADD 1 1/4" (32 mm) TO
FRAME DIMENSION AT SILL.

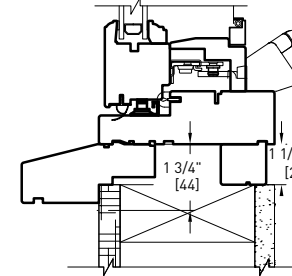

BC SUB SILL.
ADD 1 3/4" (44 mm) TO
FRAME DIMENSION AT SILL.

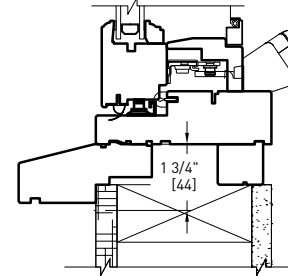

BC SUB SILL.
ADD 1 3/4" (44 mm) TO
FRAME DIMENSION AT SILL.

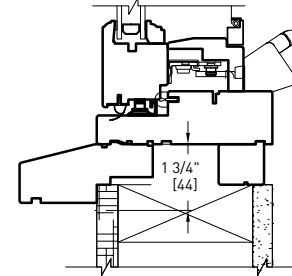

BC SUB SILL.
ADD 1 3/4" (44 mm) TO
FRAME DIMENSION AT SILL.

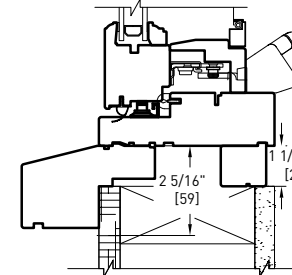

HERITAGE SUB SILL.
ADD 2 5/16" (59 mm) TO
FRAME DIMENSION AT SILL.

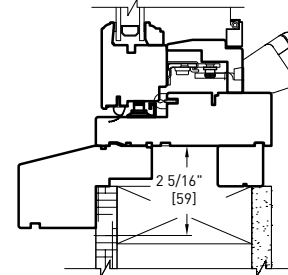

HERITAGE SUB SILL.
ADD 2 5/16" (59 mm) TO
FRAME DIMENSION AT SILL.

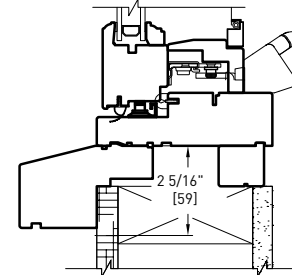

HERITAGE SUB SILL.
ADD 2 5/16" (59 mm) TO
FRAME DIMENSION AT SILL.

Note: • Other jamb widths available.

Information is subject to change without notice. | CAD download and installation instructions: www.loewen.com

Masonry Opening Wood Exterior

Casing Options

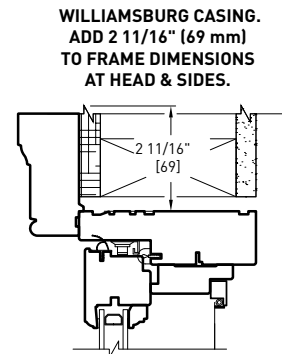
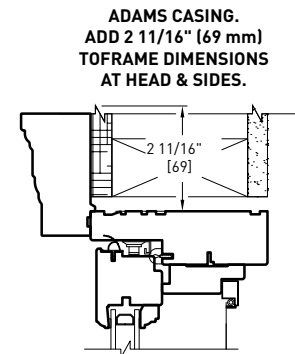

Sub Sill Options

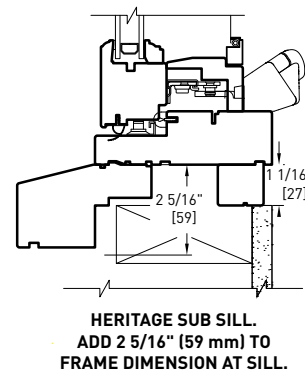
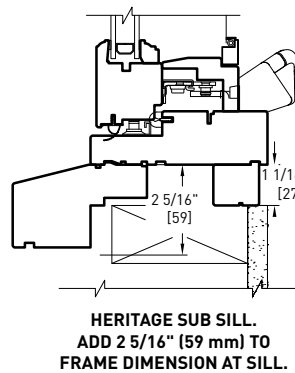
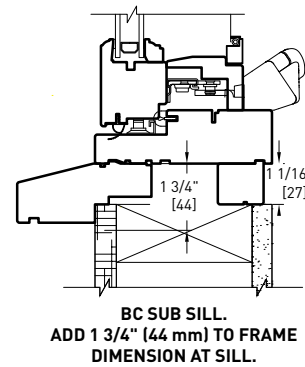
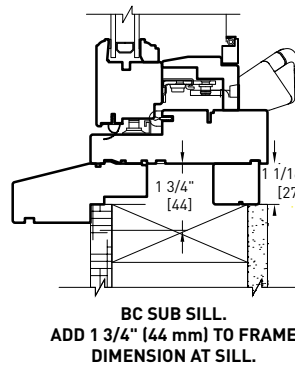

- EXAMPLE #1:** CA1 7515 with 2" Brickmould & Standard sill nose.
Frame dimensions, 29 1/2" (750mm) x 59 1/16" (1500mm).
Masonry width = 29 1/2" (750mm) + [1 9/16" (39mm) x 2] = 32 5/8" (828mm)
Masonry height = 59 1/16" (1500mm) + 1 9/16" (39mm) + 1 1/4" (32mm) = 61 15/16" (1571mm)
- EXAMPLE #2:** CA1 0918 with Adams casing & BC sill nose.
Frame dimensions, 35 7/16" (900mm) x 70 7/8" (1800mm).
Masonry width = 35 7/16" (900mm) + [2 11/16" (69mm) x 2] = 40 13/16" (1038mm)
Masonry height = 70 7/8" (1800mm) + 2 11/16" (69mm) + 1 3/4" (44mm) = 75 5/16" (1913mm)

Note: • Other jamb widths available.

Information is subject to change without notice. | CAD download and installation instructions: www.loewen.com

Masonry Clip Installation Universal

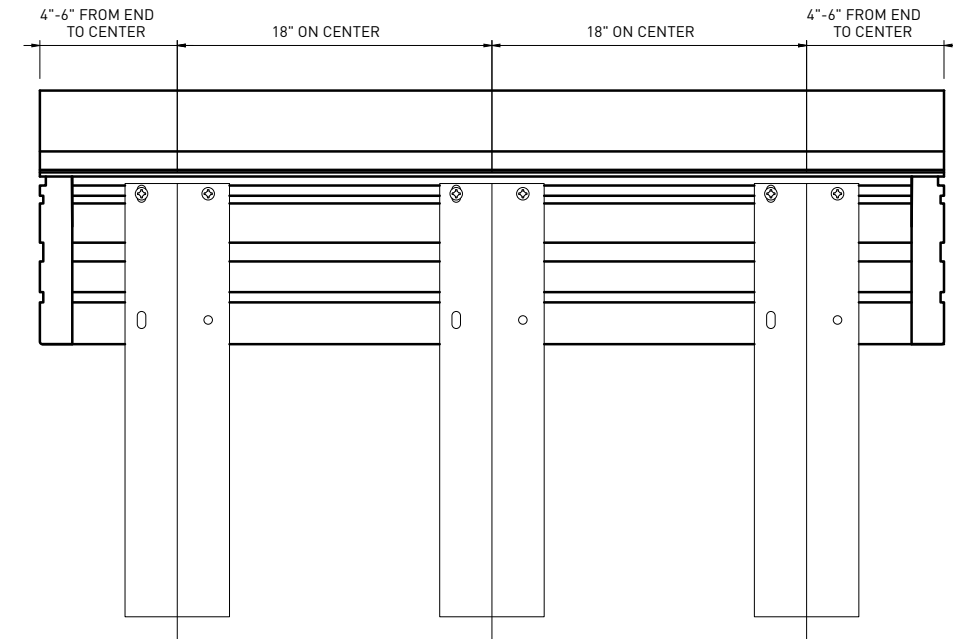

1. Start installation of masonry clips 4" to 6" from the ends of the unit to the center of the clip.
2. After placing both of the outermost clips on the unit, install the remainder of the clips moving inward to the center of the unit, placing each clip approximately 18" on center.
3. Fasten clips to unit using two 5/8" #8 Panhead screws.

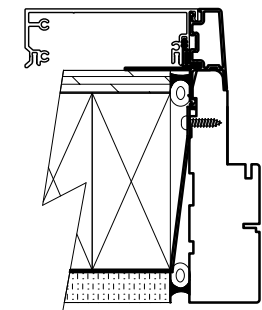
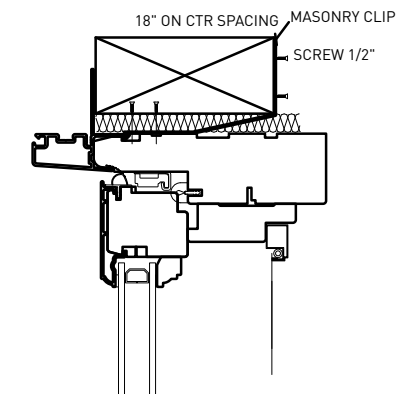

Information is subject to change without notice. | CAD download and installation instructions: www.loewen.com

32mm Jamb Extension (1 1/4")

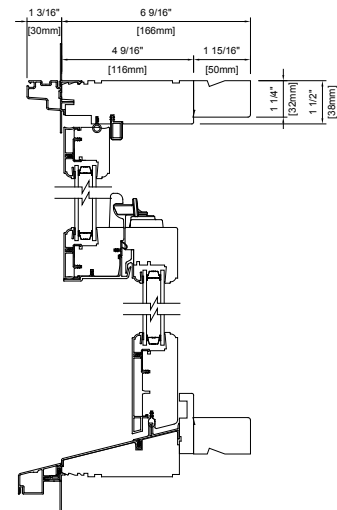

Double Hung [DH1]

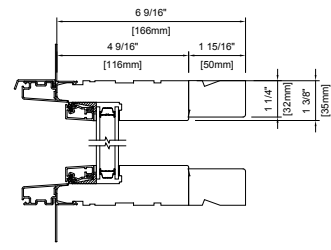

Picture [PS1]

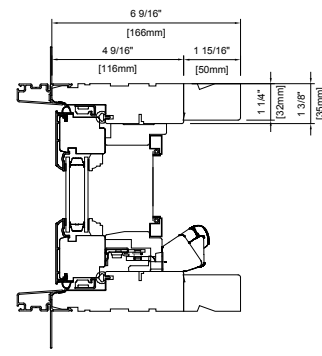

Casement [CA1]

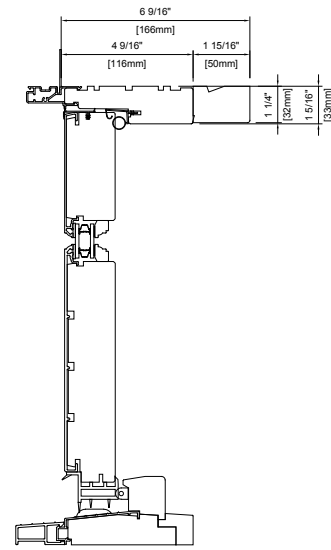

Outswing Terrace Door [TD1]

Metal Clad Spread Mullions

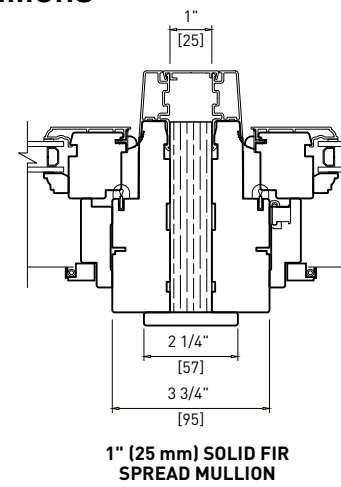

1" (25 mm) SOLID FIR SPREAD MULLION

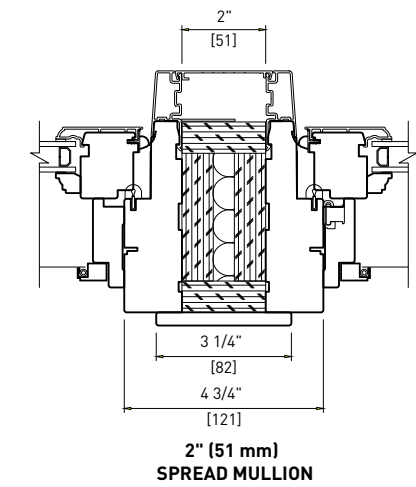

2" (51 mm) SPREAD MULLION

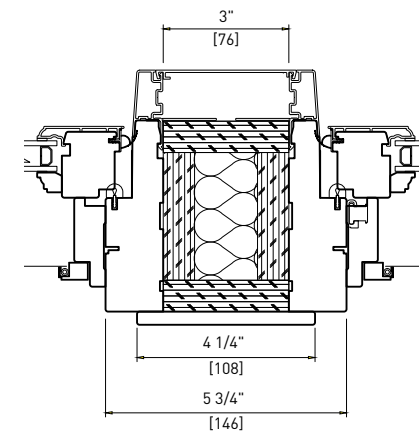

3" (76 mm) SPREAD MULLION

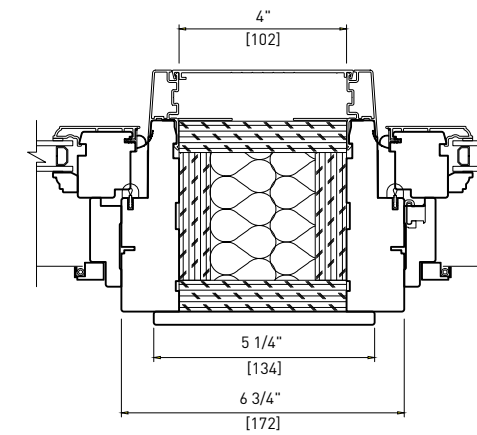

4" (102 mm) SPREAD MULLION

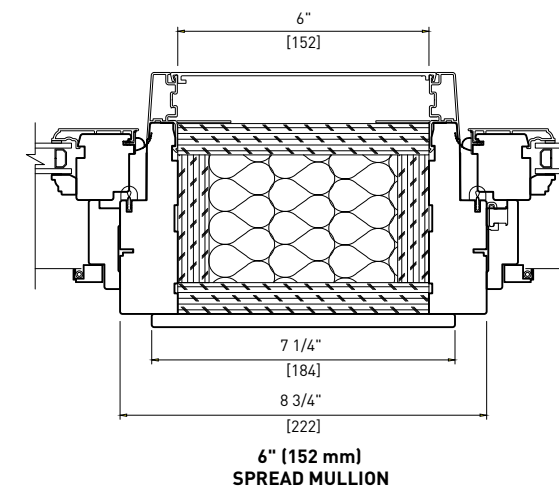

6" (152 mm) SPREAD MULLION

Note:

- Other jamb widths available.
- All dimensions to have +/- 1/16" (2mm) tolerance.

Metal Clad Stud Pocket

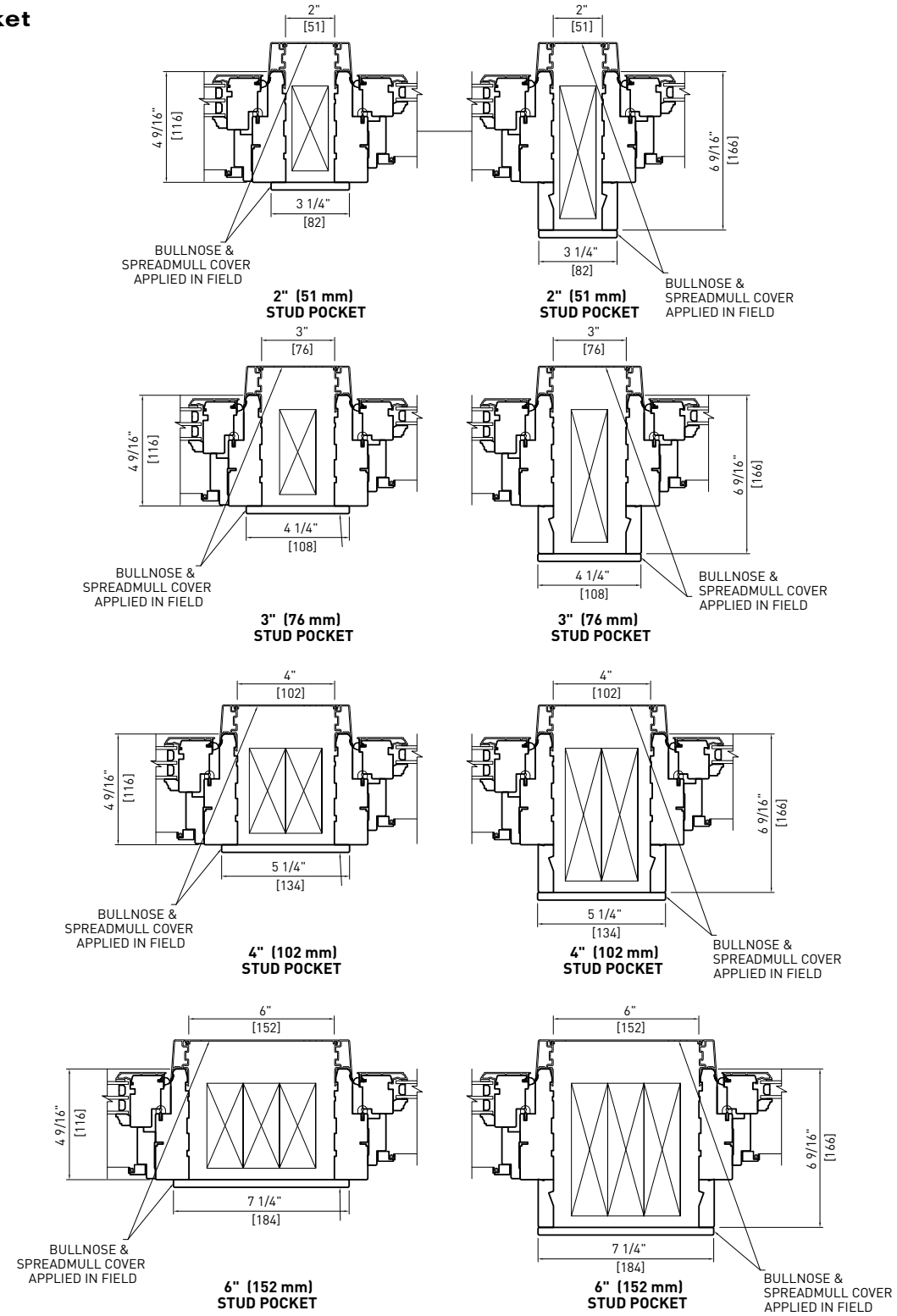

Note:

- Other jamb widths available.
- All dimensions to have +/- 1/16" (2mm) tolerance.
- Framing member designed and supplied by others.

Information is subject to change without notice. | CAD download and installation instructions: www.loewen.com

Metal Clad Stud Pocket - Double Hung

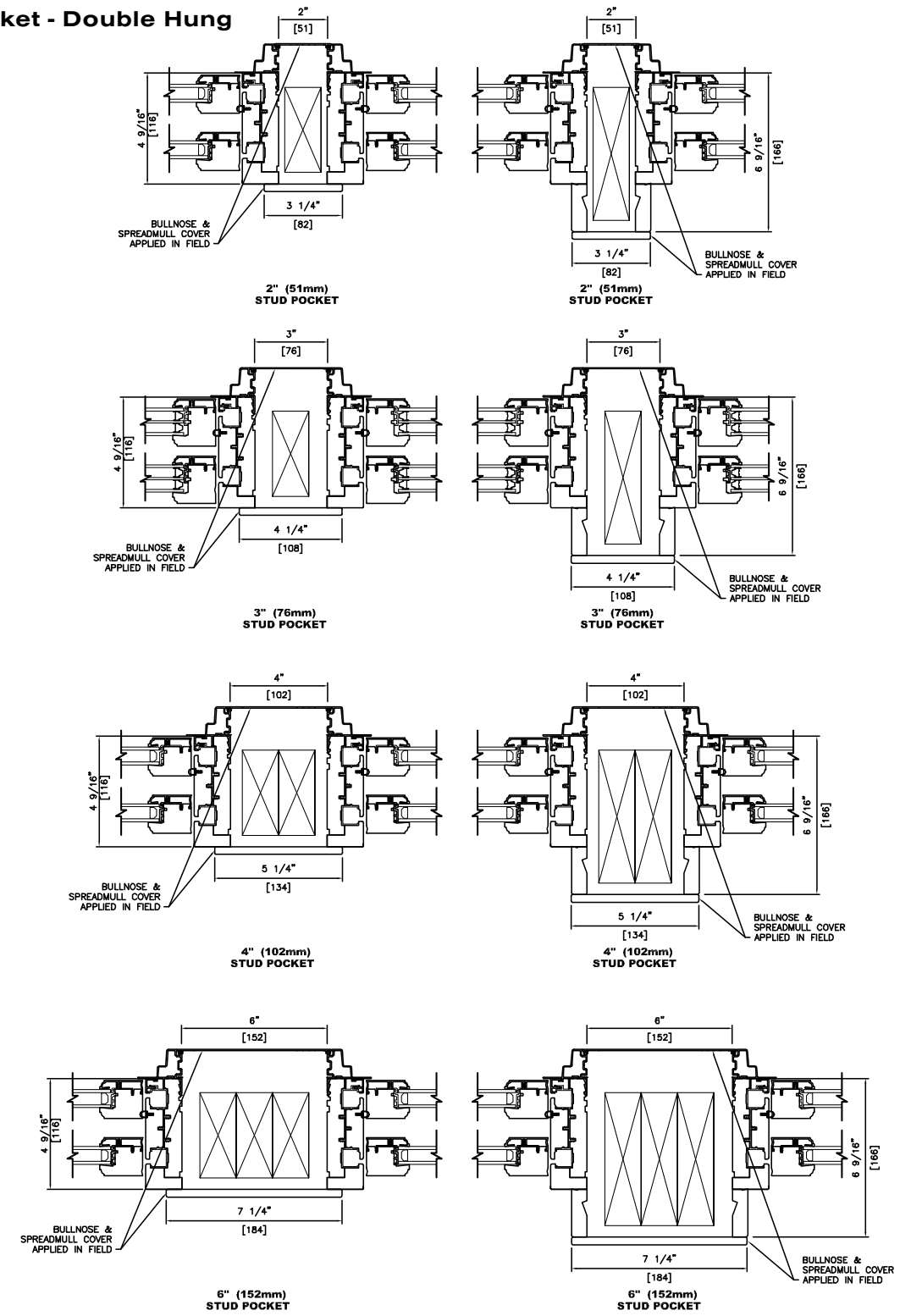

Note:

- Other jamb widths available.
- All dimensions to have +/- 1/16" (2mm) tolerance.
- Framing member designed and supplied by others.

Information is subject to change without notice. | CAD download and installation instructions: www.loewen.com

**Wood Exterior
Spread Mullions**

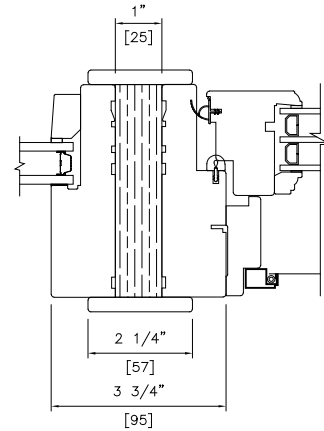

**1" (25mm) SOLID FIR
SPREAD MULLION**

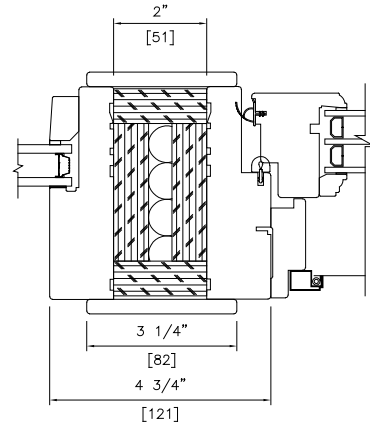

**2" (51mm)
SPREAD MULLION**

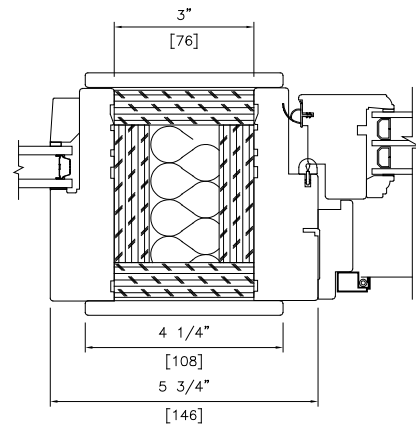

**3" (76mm)
SPREAD MULLION**

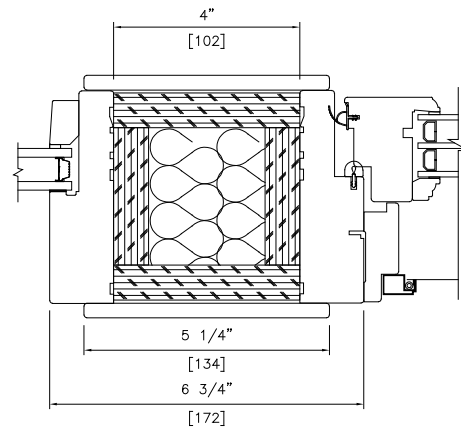

**4" (102mm)
SPREAD MULLION**

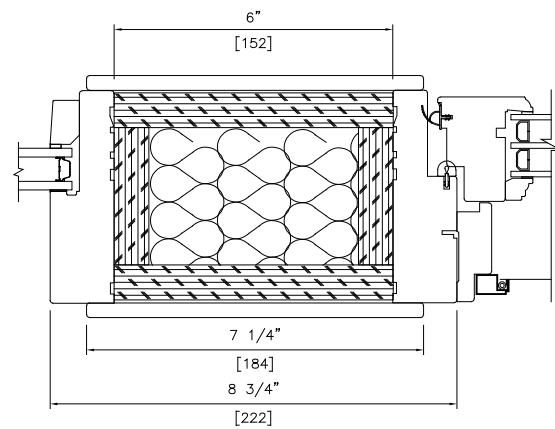

**6" (152mm)
SPREAD MULLION**

Note:

- Other jamb widths available.
- All dimensions to have +/- 1/16" (2mm) tolerance.

Information is subject to change without notice. | CAD download and installation instructions: www.loewen.com

**Wood Exterior
Stud Pocket**

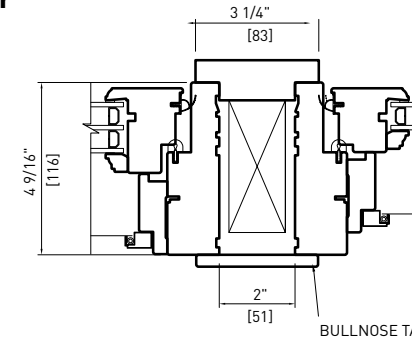

**2" (51 mm)
STUD POCKET**

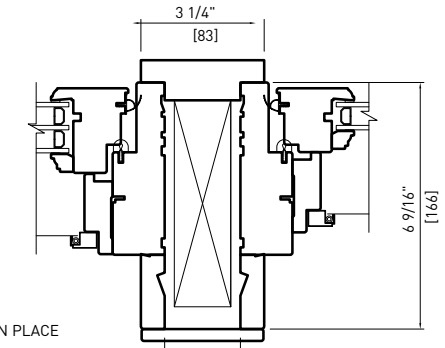

**2" (51 mm)
STUD POCKET**

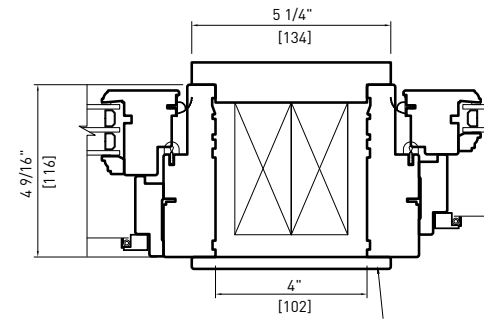

**4" (102 mm)
STUD POCKET**

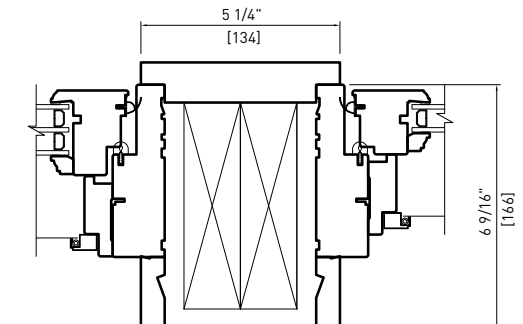

**4" (102 mm)
STUD POCKET**

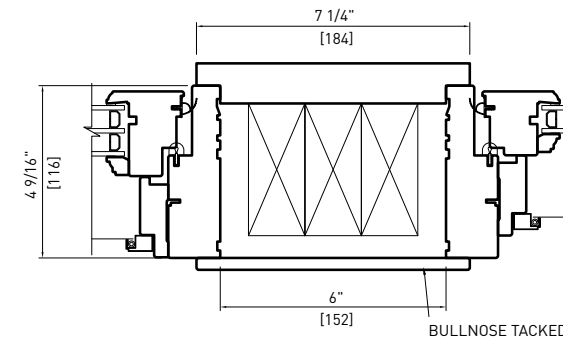

**6" (152 mm)
STUD POCKET**

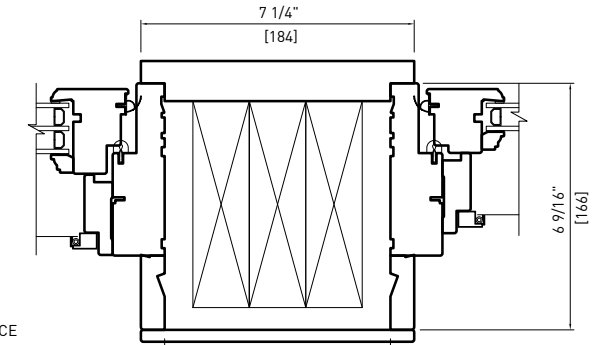

**6" (152 mm)
STUD POCKET**

Note:

- Other jamb widths available.
- All dimensions to have +/- 1/16" (2mm) tolerance.
- Framing member designed and supplied by others.

Information is subject to change without notice. | CAD download and installation instructions: www.loewen.com

**Wood Exterior
Stud Pocket - Double Hung**

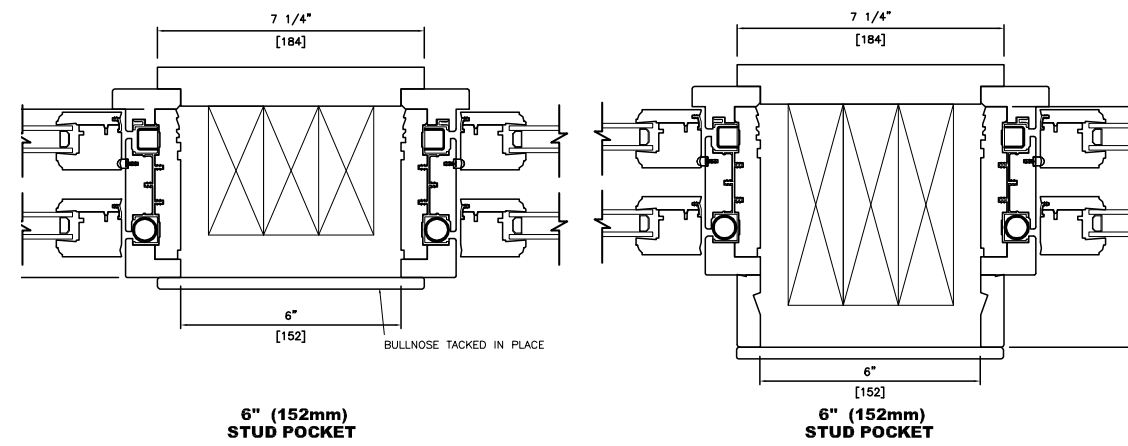
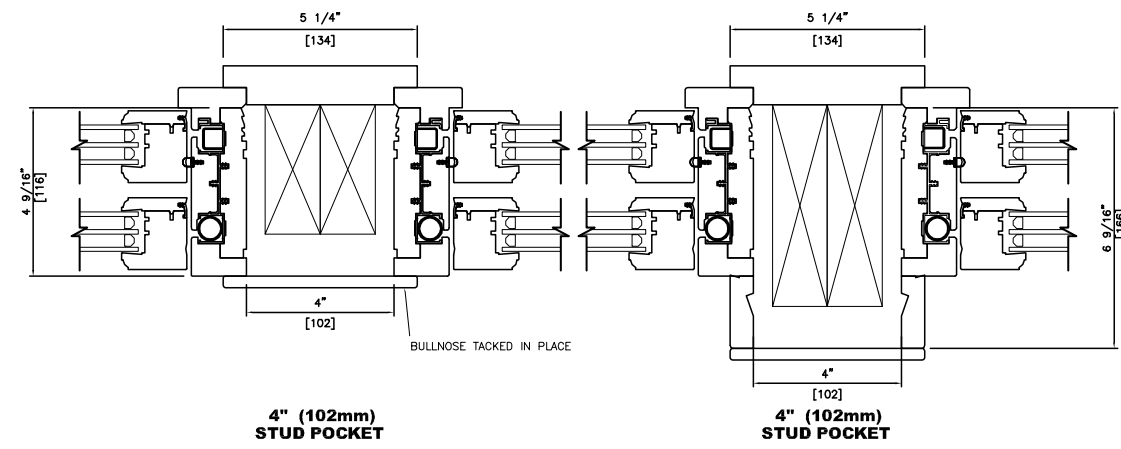
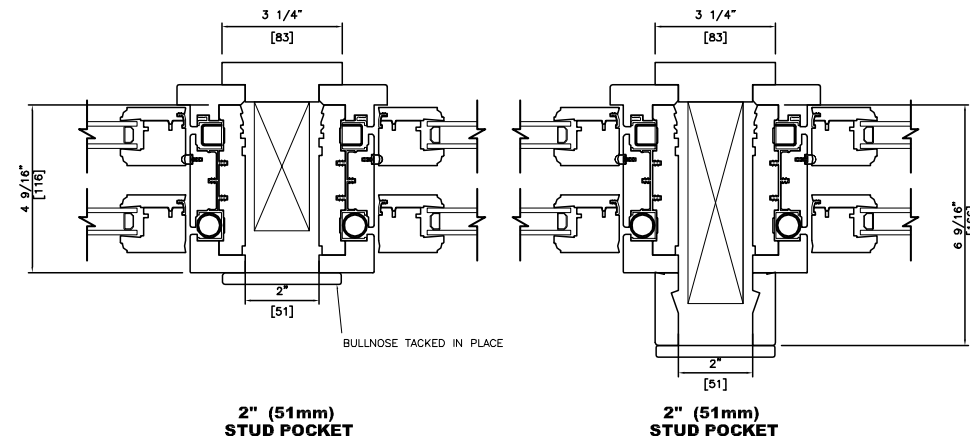

Note:

- Other jamb widths available.
- All dimensions to have +/- 1/16" (2mm) tolerance.
- Framing member designed and supplied by others.

Information is subject to change without notice. | CAD download and installation instructions: www.loewen.com

Attribution

A Cover Lake Flato Architects | Casey Dunn Photography
A2 Nautilus Homes | Ryan Gamma Photography
A5 Nastasi Architects | David Hartz Photography
A6 Schwartz and Architecture | Bruce Damonte Photography
A8 Republic Architecture
A9 Sharratt Design & Company | Phillip C. Mueller Photography
A12 Steve Wisenbaker Architects | Paul Dyer Photography
A14 Ricardo Capretta Architecture
A17 Coates Design | Lara Swimmer Photography
A19 square three architecture | Bernard Andre Photography
A25 Skylab Architects | Jeremy Bittermann Photography
A35 Steve Wisenbaker Architects | Paul Dyer Photography
B Cover bba Architects | Aimee Mazzenga Photography
C Cover Lake Flato Architects | Casey Dunn Photography
D Cover Steve Wisenbaker Architects | Paul Dyer Photography
E Cover Trent Bell Photography for Caleb Johnson Studio
F Cover Nautilus Homes | Ryan Gamma Photography
G Cover Eskuche Design | Landmark Photography
H Cover Cosan Studio | Salcito Custom Homes | Roehner Ryan Photography
J Cover Haley Whiteside Design | Brandon Haydon Construction | Peter Lyons Photography
K Cover Coates Design | Lara Swimmer Photography
L Cover LaRue Architects | Foursquare Builders | Casey Dunn Photography
M Cover Cosan Studio | Salcito Custom Homes | Roehner Ryan Photography
M2 Lake Flato Architects | Casey Dunn Photography
N Cover Nastasi Architects | David Hartz Photography
N2 John Wingfelder Architect | Heartland Homes | Kim Smith Photo

Information subject to change without notice.

Distributed by Loewen Inc. in the USA and C.P. Loewen Enterprises Ltd. in Canada and internationally. Trade Marks owned by C.P. Loewen Enterprises Ltd. Used under license.
© C.P. Loewen Enterprises Ltd. All rights reserved.



Recycled Paper
Printed in Canada
P2985A_0423