

Technical Guide G

Specialty Windows



Product Features

Styles

Picture, Fixed Casement, Operating Casement, Double Hung, Single Hung, Radius Top and Cottage options.

Standard Features

- Natural, Douglas Fir interior (no visible finger joints)
- 4 9/16" (116 mm) jamb construction
- LowE insulated glazing with 1/2" (13 mm) airspace
- Extruded aluminum cladding in a variety of standard colors, primed wood or clear fir exterior
- Flexible continuous weatherstrip system
- Insect screens with high transparency mesh option

Hardware

Multiple hardware type and finish choices are available. See the Hardware in section A for more information.

Glazing

LowE Double, LowE Triple and StormForce™. StormForce is not available on all products.

Simulated Divided Lites (SDL)

Ogee Profile – 3/4" (19 mm), 1 1/8" (30 mm), 2" (51 mm)

Putty Profile – 5/8" (16 mm), 7/8" (22 mm), 1 1/8" (30 mm), 2" (51 mm)

Square Profile (interior only) – 3/4" (19 mm), 7/8" (22 mm), 1 1/8" (30 mm), 2" (51 mm)

Casing

Wood: 2" (51 mm) Brickmould, 3 1/2" (89 mm) Flat, 5 1/2" (139 mm) Flat, Adams and Williamsburg.

Metal Clad: 2" (51 mm) Brickmould, 3 1/2" (89 mm) Flat, 2" clad frame extension, Nose & Cove, Adams, Williamsburg and Kerf.

Metal Clad Color Spectrum

All Palette colors, including anodized finishes.

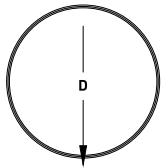

Full Round

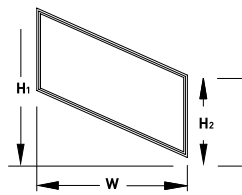

Quadrilateral

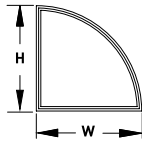

Quarter Round

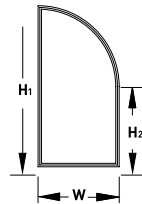

Extended Quarter Round

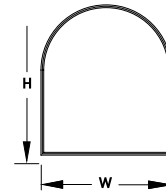

Extended Half Round

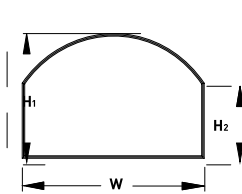

Extended Full Chord (Springline)

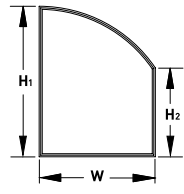

Extended Half Chord

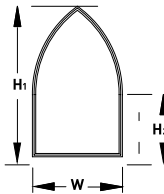

Extended Gothic

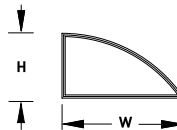

Half Chord

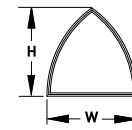

Gothic

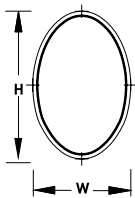

Oval

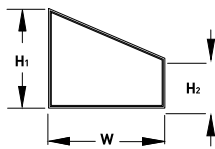

Rakehead

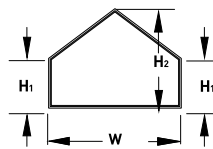

Peakhead

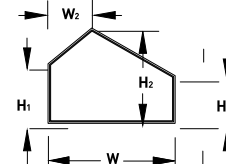

Offset Peakhead

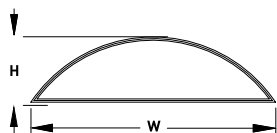

Full Chord (Circle Segment)

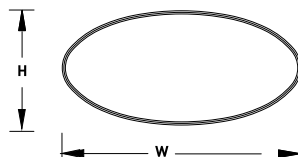

Full Ellipse

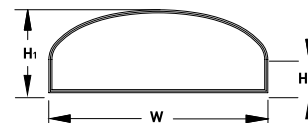

Extended Ellipse

Specifications

Frame & Sash

Manufactured from Coastal Douglas Fir kiln-dried lumber with frame construction designed for 4 9/16" (116 mm) jamb. All wood exterior components are factory primed unless specified as clear exterior. Minor scratches or abrasions in the wood surface or primer are not considered defects.

Alternate Species

The entire Loewen product line is also available in optional Mahogany.

Interior Casing (Radius Shapes Only)

A unique manufacturing technique utilizes continuous wood strips, laminated to form a one-piece casing which can be painted or stained to match other wood finishes.

Preservative Treated

All wood parts are dipped in approved preservative.

Glazing

With countless glazing configurations and LowE coating options, we ensure that you can choose the perfect blend of protection and comfort.

Insulating Glass

Double or triple glass configurations with 1/2" (13 mm) airspace.

LowE Systems

LowE best describes the benefits of the product that incorporates glazing coatings and Argon gas. LowE systems help reduce heating and cooling costs, providing superior energy efficiency.

Simulated Divided Lites (SDL)

Standard SDL complete with airspace grilles, where available. Grille bars are permanently applied to the interior and exterior.

Decorative Glazing Designs

All products in this catalog are available with decorative glass designs which include etched glass, textured, beveled glass and much more.

Metal Cladding

Heavy duty exterior metal cladding comprised of extruded aluminum is available in a variety of Palette colors, including anodized and Cyprium (copper and bronze cladding). Interior of window can be natural wood (unfinished) or primed. Metal clad units are supplied ready-to-install complete with integral metal nailing flange.

Specialty Window Sizes

Half Round Windows

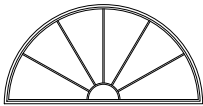
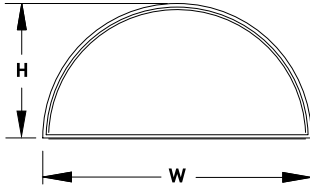

Standard Optional Grille

UNIT SIZES				
MODEL NUMBER	UNIT O.S.M. (Imperial)	ROUGH OPENING (Imperial)	UNIT O.S.M. (Metric)	ROUGH OPENING (Metric)
RT 0603	23 5/8 X 11 13/16	24 3/8 X 12 9/16	600 X 300	619 X 319
RT 0735	27 9/16 X 13 3/4	28 5/16 X 14 1/2	700 X 350	719 X 369
RT 0804	31 1/2 X 15 3/4	32 1/4 X 16 1/2	800 X 400	819 X 419
RT 0945	35 7/16 X 17 11/16	36 3/16 X 18 7/16	900 X 450	919 X 469
RT 1005	39 3/8 X 19 11/16	40 1/8 X 20 7/16	1000 X 500	1019 X 519
RT 1206	47 1/4 X 23 5/8	48 X 24 3/8	1200 X 600	1219 X 619
RT 1407	55 1/8 X 27 9/16	55 7/8 X 28 5/16	1400 X 700	1419 X 719
RT 1608	63 X 31 1/2	63 3/4 X 32 1/4	1600 X 800	1619 X 819
RT 1809	70 7/8 X 35 7/16	71 5/8 X 36 3/16	1800 X 900	1819 X 919
RT 2010	78 3/4 X 39 3/8	79 1/2 X 40 1/8	2000 X 1000	2019 X 1019
RT 2412	94 1/2 X 47 1/4	95 1/4 X 48	2400 X 1200	2419 X 1219
RT 2613	102 3/8 X 51 3/16	103 1/8 X 51 15/16	2600 X 1300	2619 X 1319
RT 2814	110 1/4 X 55 1/8	111 X 55 7/8	2800 X 1400	2819 X 1419
RT 3015	118 1/8 X 59 1/16	118 7/8 X 59 13/16	3000 X 1500	3019 X 1519

Extended Half Round Windows

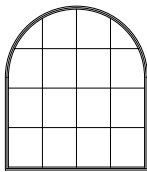
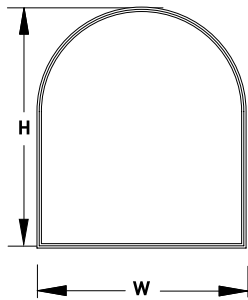

Standard Optional Grille

UNIT SIZES				
MODEL NUMBER	UNIT O.S.M. (Imperial)	ROUGH OPENING (Imperial)	UNIT O.S.M. (Metric)	ROUGH OPENING (Metric)
ER 0810	31 1/2 X 39 3/8	32 1/4 X 40 1/8	800 X 1000	819 X 1019
ER 0812	31 1/2 X 47 1/4	32 1/4 X 48	800 X 1200	819 X 1219
ER 0814	31 1/2 X 55 1/8	32 1/4 X 55 7/8	800 X 1400	819 X 1419
ER 1010	39 3/8 X 39 3/8	40 1/8 X 40 1/8	1000 X 1000	1019 X 1019
ER 1012	39 3/8 X 47 1/4	40 1/8 X 48	1000 X 1200	1019 X 1219
ER 1014	39 3/8 X 55 1/8	40 1/8 X 55 7/8	1000 X 1400	1019 X 1419
ER 1016	39 3/8 X 63	40 1/8 X 63 3/4	1000 X 1600	1019 X 1619
ER 1018	39 3/8 X 70 7/8	40 1/8 X 71 5/8	1000 X 1800	1019 X 1819
ER 1212	47 1/4 X 47 1/4	48 X 48	1200 X 1200	1219 X 1219
ER 1214	47 1/4 X 55 1/8	48 X 55 7/8	1200 X 1400	1219 X 1419
ER 1216	47 1/4 X 63	48 X 63 3/4	1200 X 1600	1219 X 1619
ER 1218	47 1/4 X 70 7/8	48 X 71 5/8	1200 X 1800	1219 X 1819
ER 1414	55 1/8 X 55 1/8	55 7/8 X 55 7/8	1400 X 1400	1419 X 1419
ER 1416	55 1/8 X 63	55 7/8 X 63 3/4	1400 X 1600	1419 X 1619
ER 1418	55 1/8 X 70 7/8	55 7/8 X 71 5/8	1400 X 1800	1419 X 1819
ER 1616	63 X 63	63 3/4 X 63 3/4	1600 X 1600	1619 X 1619
ER 1618	63 X 70 7/8	63 3/4 X 71 5/8	1600 X 1800	1619 X 1819
ER 1818	70 7/8 X 70 7/8	71 5/8 X 71 5/8	1800 X 1800	1819 X 1819
ER 2418	94 1/2 X 70 7/8	95 1/4 X 71 5/8	2400 X 1800	2419 X 1819

Note:

- SDL/Grille patterns are dependent on SDL/Grille type. All patterns shown in this catalog are for illustration purposes only – please verify SDL/Grille patterns before confirming your order.
- Specialty shape units are available in Casement and Picture/Direct Set configurations. Additional sizes beyond those shown here are available. Contact your Authorized Loewen Dealer for assistance.

Specialty Window Sizes

Quarter Round Windows

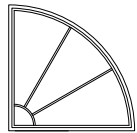
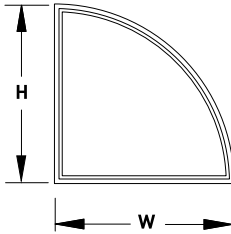

Standard Optional Grille

UNIT SIZES				
MODEL NUMBER	UNIT O.S.M. (Imperial)	ROUGH OPENING (Imperial)	UNIT O.S.M. (Metric)	ROUGH OPENING (Metric)
QR 505	19 11/16 X 19 11/16	20 7/16 X 20 7/16	500 X 500	519 X 519
QR 606	23 5/8 X 23 5/8	24 3/8 X 24 3/8	600 X 600	619 X 619
QR 909	35 7/16 X 35 7/16	36 3/16 X 36 3/16	900 X 900	919 X 919
QR 1010	39 3/8 X 39 3/8	40 1/8 X 40 1/8	1000 X 1000	1019 X 1019
QR 1212	47 1/4 X 47 1/4	48 X 48	1200 X 1200	1219 X 1219
QR 1414	55 1/8 X 55 1/8	55 7/8 X 55 7/8	1400 X 1400	1419 X 1419

Extended Quarter Round Windows

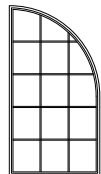
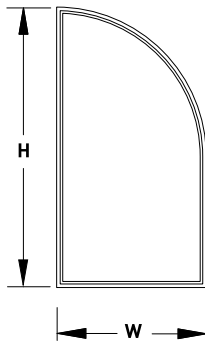

Standard Optional Grille

UNIT SIZES				
MODEL NUMBER	UNIT O.S.M. (Imperial)	ROUGH OPENING (Imperial)	UNIT O.S.M. (Metric)	ROUGH OPENING (Metric)
EQ 0510	19 11/16 X 39 3/8	20 7/16 X 40 1/8	500 X 1000	519 X 1019
EQ 0512	19 11/16 X 47 1/4	20 7/16 X 48	500 X 1200	519 X 1219
EQ 0612	23 5/8 X 47 1/4	24 3/8 X 48	600 X 1200	619 X 1219
EQ 0614	23 5/8 X 55 1/8	24 3/8 X 55 7/8	600 X 1400	619 X 1419
EQ 0712	27 9/16 X 47 1/4	28 5/16 X 48	700 X 1200	719 X 1219
EQ 0714	27 9/16 X 55 1/8	28 5/16 X 55 7/8	700 X 1400	719 X 1419
EQ 0716	27 9/16 X 63	28 5/16 X 63 3/4	700 X 1600	719 X 1619
EQ 0814	31 1/2 X 55 1/8	32 1/4 X 55 7/8	800 X 1400	819 X 1419
EQ 0816	31 1/2 X 63	32 1/4 X 63 3/4	800 X 1600	819 X 1619
EQ 0818	31 1/2 X 70 7/8	32 1/4 X 71 5/8	800 X 1800	819 X 1819
EQ 0916	35 7/16 X 63	36 3/16 X 63 3/4	900 X 1600	919 X 1619
EQ 0918	35 7/16 X 70 7/8	36 3/16 X 71 5/8	900 X 1800	919 X 1819
EQ 1016	39 3/8 X 63	40 1/8 X 63 3/4	1000 X 1600	1019 X 1619
EQ 1018	39 3/8 X 70 7/8	40 1/8 X 71 5/8	1000 X 1800	1019 X 1819
EQ 1218	47 1/4 X 70 7/8	48 X 71 5/8	1200 X 1800	1219 X 1819
EQ 1418	55 1/8 X 70 7/8	55 7/8 X 71 5/8	1400 X 1800	1419 X 1819

- Note:**
- SDL/Grille patterns are dependent on SDL/Grille type. All patterns shown in this catalog are for illustration purposes only – please verify SDL/Grille patterns before confirming your order.
 - Specialty shape units are available in Casement and Picture/Direct Set configurations. Additional sizes beyond those shown here are available. Contact your Authorized Loewen Dealer for assistance.

Specialty Window Sizes

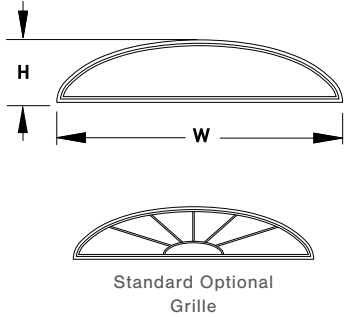

Elliptical Windows

MODEL NUMBER	UNIT SIZES			
	UNIT O.S.M. (Imperial)	ROUGH OPENING (Imperial)	UNIT O.S.M. (Metric)	ROUGH OPENING (Metric)
EL 0800	31 1/2 X 9 13/16	32 1/4 X 10 9/16	800 X 250	819 X 269
EL 0900	35 7/16 X 9 13/16	36 3/16 X 10 9/16	900 X 250	919 X 269
EL 1000	39 3/8 X 9 13/16	40 1/8 X 10 9/16	1000 X 250	1019 X 269
EL 1200	47 1/4 X 11 13/16	48 X 12 9/16	1200 X 300	1219 X 319
EL 1400	55 1/8 X 11 13/16	55 7/8 X 12 9/16	1400 X 300	1419 X 319
EL 1600	63 X 13 3/4	63 3/4 X 14 1/2	1600 X 350	1619 X 369
EL 1800	70 7/8 X 13 3/4	71 5/8 X 14 1/2	1800 X 350	1819 X 369

Extended Elliptical Windows

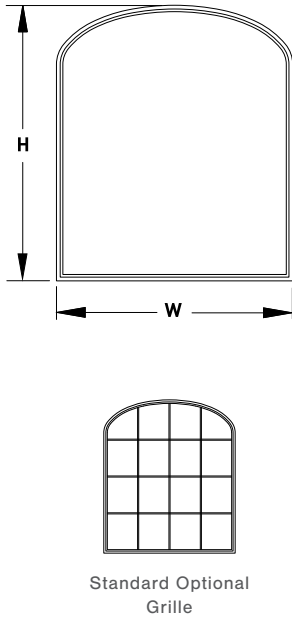

MODEL NUMBER	UNIT SIZES			
	UNIT O.S.M. (Imperial)	ROUGH OPENING (Imperial)	UNIT O.S.M. (Metric)	ROUGH OPENING (Metric)
EE 0808	31 1/2 X 31 1/2	32 1/4 X 32 1/4	800 X 800	819 X 819
EE 0810	31 1/2 X 39 3/8	32 1/4 X 40 1/8	800 X 1000	819 X 1019
EE 0812	31 1/2 X 47 1/4	32 1/4 X 48	800 X 1200	819 X 1219
EE 1010	39 3/8 X 39 3/8	40 1/8 X 40 1/8	1000 X 1000	1019 X 1019
EE 1012	39 3/8 X 47 1/4	40 1/8 X 48	1000 X 1200	1019 X 1219
EE 1014	39 3/8 X 55 1/8	40 1/8 X 55 7/8	1000 X 1400	1019 X 1419
EE 1212	47 1/4 X 47 1/4	48 X 48	1200 X 1200	1219 X 1219
EE 1214	47 1/4 X 55 1/8	48 X 55 7/8	1200 X 1400	1219 X 1419
EE 1216	47 1/4 X 63	48 X 63 3/4	1200 X 1600	1219 X 1619
EE 1414	55 1/8 X 55 1/8	55 7/8 X 55 7/8	1400 X 1400	1419 X 1419
EE 1416	55 1/8 X 63	55 7/8 X 63 3/4	1400 X 1600	1419 X 1619
EE 1418	55 1/8 X 70 7/8	55 7/8 X 71 5/8	1400 X 1800	1419 X 1819
EE 1616	63 X 63	63 3/4 X 63 3/4	1600 X 1600	1619 X 1619
EE 1818	70 7/8 X 70 7/8	71 5/8 X 71 5/8	1800 X 1800	1819 X 1819

Note:

- SDL/Grille patterns are dependent on SDL/Grille type. All patterns shown in this catalog are for illustration purposes only – please verify SDL/Grille patterns before confirming your order.
- Specialty shape units are available in Casement and Picture/Direct Set configurations. Additional sizes beyond those shown here are available. Contact your Authorized Loewen Dealer for assistance.

Specialty Window Sizes

Half Chord Windows

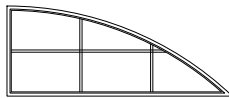
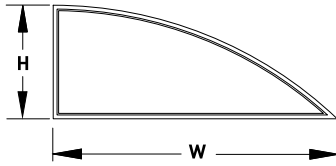

Standard Optional Grille

MODEL NUMBER	UNIT SIZES			
	UNIT O.S.M. (Imperial)	ROUGH OPENING (Imperial)	UNIT O.S.M. (Metric)	ROUGH OPENING (Metric)
HC 0500	19 11/16 X 9 13/16	20 13/16 X 10 9/16	500 X 250	528 X 269
HC 0600	23 5/8 X 11 13/16	24 3/4 X 12 9/16	600 X 300	628 X 319
HC 0700	27 9/16 X 11 13/16	28 13/16 X 12 9/16	700 X 300	731 X 319
HC 0800	31 1/2 X 13 3/4	32 11/16 X 14 1/2	800 X 350	831 X 369
HC 0900	35 7/16 X 13 3/4	36 3/4 X 14 1/2	900 X 350	934 X 369
HC 1000	39 3/8 X 15 3/4	40 11/16 X 16 1/2	1000 X 400	1033 X 419
HC 1200	47 1/4 X 15 3/4	48 3/4 X 16 1/2	1200 X 400	1238 X 419
HC 1400	55 1/8 X 17 11/16	56 5/8 X 18 7/16	1400 X 450	1439 X 469

Extended Half Chord Windows

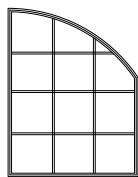
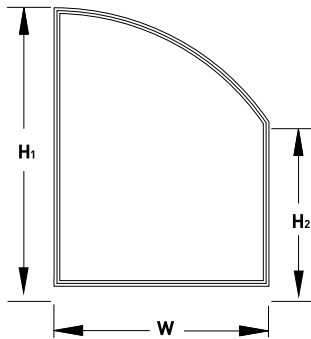

Standard Optional Grille

MODEL NUMBER	UNIT SIZES			
	UNIT O.S.M. (Imperial)	ROUGH OPENING (Imperial)	UNIT O.S.M. (Metric)	ROUGH OPENING (Metric)
EH 0512	19 11/16 X 39 3/8	20 7/16 X 40 1/8	500 X 1000	519 X 1019
EH 0510	19 11/16 X 47 1/4	20 7/16 X 48	500 X 1200	519 X 1219
EH 0612	23 5/8 X 47 1/4	24 3/8 X 48	600 X 1200	619 X 1219
EH 0614	23 5/8 X 55 1/8	24 3/8 X 55 7/8	600 X 1400	619 X 1419
EH 0712	27 9/16 X 47 1/4	28 5/16 X 48	700 X 1200	719 X 1219
EH 0714	27 9/16 X 55 1/8	28 5/16 X 55 7/8	700 X 1400	719 X 1419
EH 0716	27 9/16 X 63	28 5/16 X 63 3/4	700 X 1600	719 X 1619
EH 0814	31 1/2 X 55 1/8	32 1/4 X 55 7/8	800 X 1400	819 X 1419
EH 0816	31 1/2 X 63	32 1/4 X 63 3/4	800 X 1600	819 X 1619
EH 0818	31 1/2 X 70 7/8	32 1/4 X 71 5/8	800 X 1800	819 X 1819
EH 0916	35 7/16 X 63	36 3/16 X 63 3/4	900 X 1600	919 X 1619
EH 0918	35 7/16 X 70 7/8	36 3/16 X 71 5/8	900 X 1800	919 X 1819
EH 1016	39 3/8 X 63	40 1/8 X 63 3/4	1000 X 1600	1019 X 1619
EH 1018	39 3/8 X 70 7/8	40 1/8 X 71 5/8	1000 X 1800	1019 X 1819
EH 1218	47 1/4 X 70 7/8	48 X 71 5/8	1200 X 1800	1219 X 1819
EH 1418	55 1/8 X 70 7/8	55 7/8 X 71 5/8	1400 X 1800	1419 X 1819

Note:

- SDL/Grille patterns are dependent on SDL/Grille type. All patterns shown in this catalog are for illustration purposes only – please verify SDL/Grille patterns before confirming your order.
- Specialty shape units are available in Casement and Picture/Direct Set configurations. Additional sizes beyond those shown here are available. Contact your Authorized Loewen Dealer for assistance.

Specialty Window Sizes

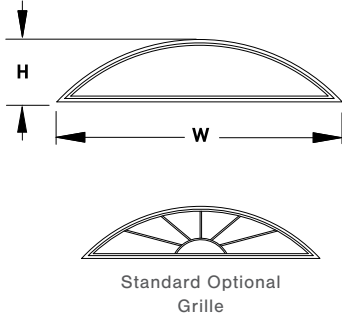

Full Chord Windows

MODEL NUMBER	UNIT SIZES			
	UNIT O.S.M. (Imperial)	ROUGH OPENING (Imperial)	UNIT O.S.M. (Metric)	ROUGH OPENING (Metric)
FC 0800	31 1/2 X 9 13/16	32 11/16 X 10 9/16	800 X 250	830 X 269
FC 0900	31 1/2 X 9 13/16	36 3/4 X 10 9/16	900 X 250	934 X 269
FC 1000	39 3/8 X 9 13/16	40 13/16 X 10 9/16	1000 X 250	1037 X 269
FC 1200	47 1/4 X 11 13/16	48 11/16 X 12 9/16	1200 X 300	1237 X 319
FC 1400	55 1/8 X 11 13/16	56 13/16 X 12 9/16	1400 X 300	1444 X 319
FC 1600	63 X 13 3/4	64 11/16 X 14 1/2	1600 X 350	1643 X 369
FC 1800	70 7/8 X 13 3/4	72 3/4 X 14 1/2	1800 X 350	1848 X 369

Extended Full Chord Windows

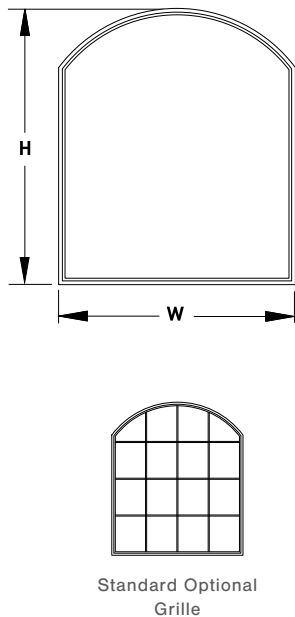

MODEL NUMBER	UNIT SIZES			
	UNIT O.S.M. (Imperial)	ROUGH OPENING (Imperial)	UNIT O.S.M. (Metric)	ROUGH OPENING (Metric)
EF 0808	31 1/2 X 31 1/2	32 1/4 X 32 1/4	800 X 800	819 X 819
EF 0810	31 1/2 X 39 3/8	32 1/4 X 40 1/8	800 X 1000	819 X 1019
EF 0812	31 1/2 X 47 1/4	32 1/4 X 48	800 X 1200	819 X 1219
EF 1010	39 3/8 X 39 3/8	40 1/8 X 40 1/8	1000 X 1000	1019 X 1019
EF 1012	39 3/8 X 47 1/4	40 1/8 X 48	1000 X 1200	1019 X 1219
EF 1014	39 3/8 X 55 1/8	40 1/8 X 55 7/8	1000 X 1400	1019 X 1419
EF 1212	47 1/4 X 47 1/4	48 X 48	1200 X 1200	1219 X 1219
EF 1214	47 1/4 X 55 1/8	48 X 55 7/8	1200 X 1400	1219 X 1419
EF 1216	47 1/4 X 63	48 X 63 3/4	1200 X 1600	1219 X 1619
EF 1414	55 1/8 X 55 1/8	55 7/8 X 55 7/8	1400 X 1400	1419 X 1419
EF 1416	55 1/8 X 63	55 7/8 X 63 3/4	1400 X 1600	1419 X 1619
EF 1418	55 1/8 X 70 7/8	55 7/8 X 71 5/8	1400 X 1800	1419 X 1819
EF 1616	63 X 63	63 3/4 X 63 3/4	1600 X 1600	1619 X 1619
EF 1618	70 7/8 X 70 7/8	71 5/8 X 71 5/8	1600 X 1800	1619 X 1819
EF 1818	70 7/8 X 70 7/8	71 5/8 X 71 5/8	1800 X 1800	1819 X 1819

Note:

- SDL/Grille patterns are dependent on SDL/Grille type. All patterns shown in this catalog are for illustration purposes only – please verify SDL/Grille patterns before confirming your order.
- Specialty shape units are available in Casement and Picture/Direct Set configurations. Additional sizes beyond those shown here are available. Contact your Authorized Loewen Dealer for assistance.

Specialty Window Sizes

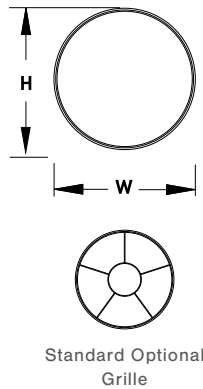

Full Round Windows

UNIT SIZES				
MODEL NUMBER	UNIT O.S.M. (Imperial)	ROUGH OPENING (Imperial)	UNIT O.S.M. (Metric)	ROUGH OPENING (Metric)
FR 0606	23 5/8 X 23 5/8	24 3/8 X 24 3/8	600 X 600	619 X 619
FR 0808	31 1/2 X 31 1/2	32 1/4 X 32 1/4	800 X 800	819 X 819
FR 0909	35 7/16 X 35 7/16	36 3/16 X 36 3/16	900 X 900	919 X 919
FR 1010	39 3/8 X 39 3/8	40 1/8 X 40 1/8	1000 X 1000	1019 X 1019
FR 1212	47 1/4 X 47 1/4	48 X 48	1200 X 1200	1219 X 1219
FR 1414	55 1/8 X 55 1/8	55 7/8 X 55 7/8	1400 X 1400	1419 X 1419
FR 1616	63 X 63	63 3/4 X 63 3/4	1600 X 1600	1619 X 1619
FR 1818	70 7/8 X 70 7/8	71 5/8 X 71 5/8	1800 X 1800	1819 X 1819

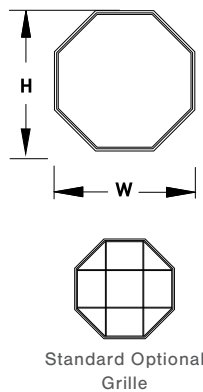

Octagon Windows

UNIT SIZES				
MODEL NUMBER	UNIT O.S.M. (Imperial)	ROUGH OPENING (Imperial)	UNIT O.S.M. (Metric)	ROUGH OPENING (Metric)
OW 0606	23 5/8 X 23 5/8	24 3/8 X 24 3/8	600 X 600	619 X 619
OW 0808	31 1/2 X 31 1/2	32 1/4 X 32 1/4	800 X 800	819 X 819
OW 1010	39 3/8 X 39 3/8	40 1/8 X 40 1/8	1000 X 1000	1019 X 1019

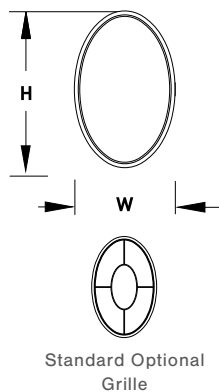

Oval Windows

UNIT SIZES				
MODEL NUMBER	UNIT O.S.M. (Imperial)	ROUGH OPENING (Imperial)	UNIT O.S.M. (Metric)	ROUGH OPENING (Metric)
OV 7512	29 1/2 X 47 1/4	30 1/4 X 48	750 X 1200	769 X 1219
OV 0914	35 7/16 X 55 1/8	36 3/16 X 55 7/8	900 X 1400	919 X 1419
OV 1275	47 1/4 X 29 1/2	48 X 30 1/4	1200 X 750	1219 X 769
OV 1409	55 1/8 X 35 7/16	55 7/8 X 36 3/16	1400 X 900	1419 X 919

- Note:**
- SDL/Grille patterns are dependent on SDL/Grille type. All patterns shown in this catalog are for illustration purposes only – please verify SDL/Grille patterns before confirming your order.
 - Specialty shape units are available in Casement and Picture/Direct Set configurations. Additional sizes beyond those shown here are available. Contact your Authorized Loewen Dealer for assistance.

Specialty Window Wall Connection Detail

Head & Sill Detail

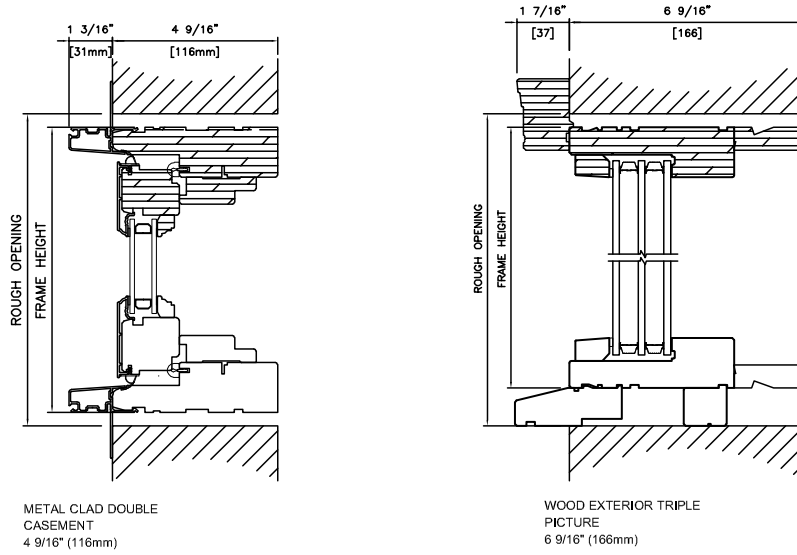

Plan View

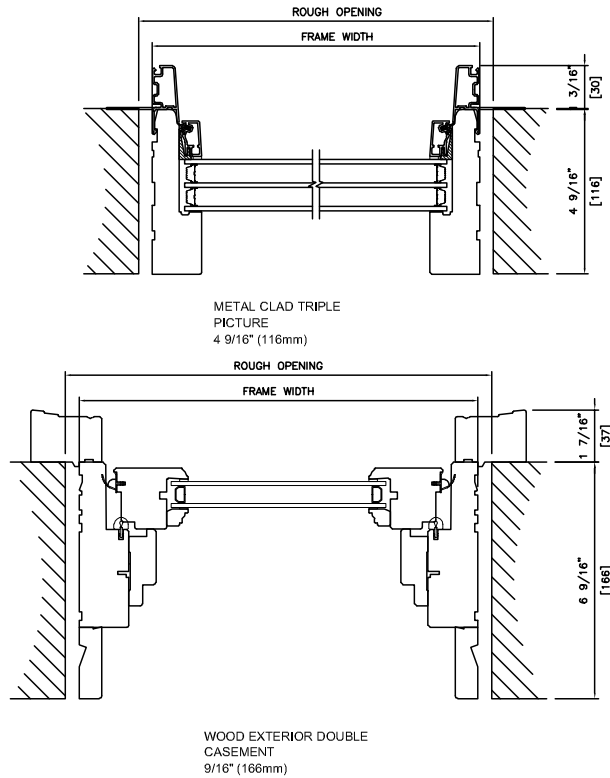

Note:

- Other jamb widths available.
- All dimensions to have +/- 1/16" (2mm) tolerance.

Non Extended Specialty Window Detail

Head & Sill Detail

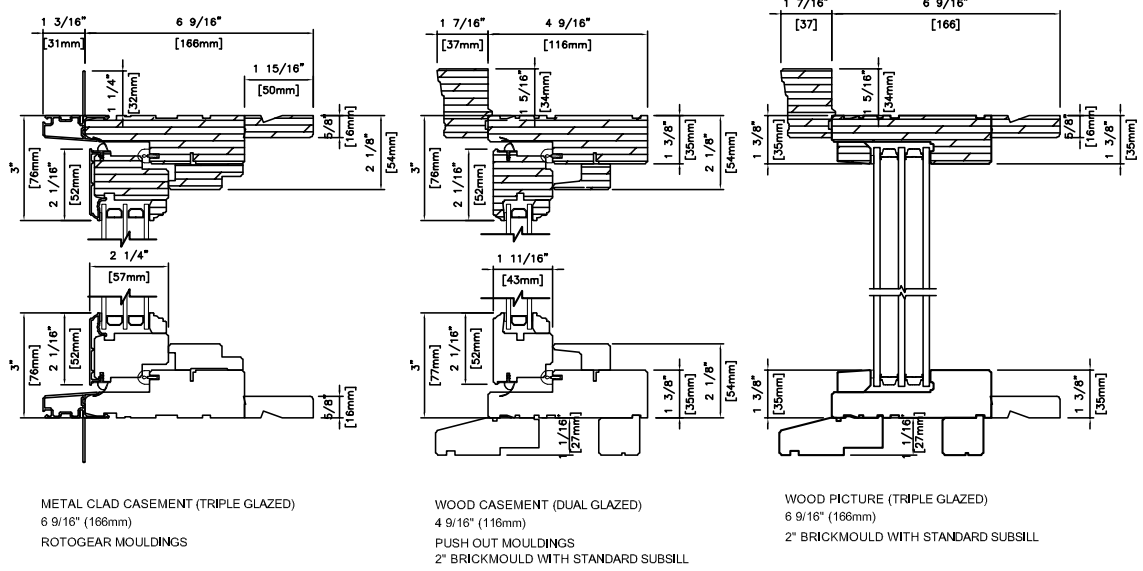

Head & Sill Detail

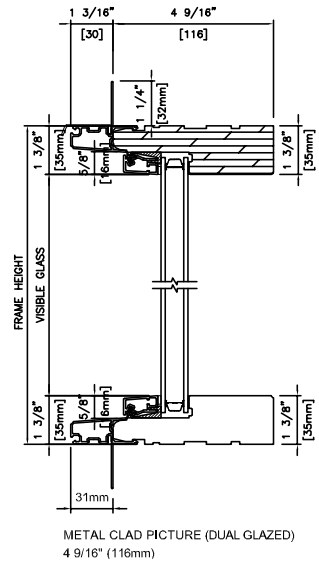

Plan View

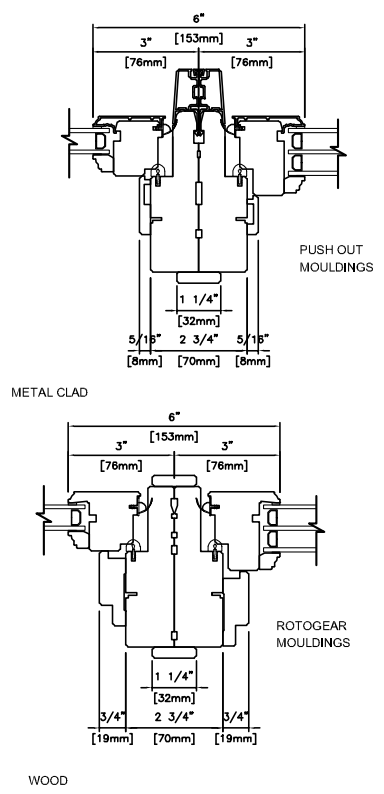

Note:

- Other jamb widths available.
- All dimensions to have +/- 1/16" (2mm) tolerance.

Extended Specialty Window Detail

Head & Sill Detail

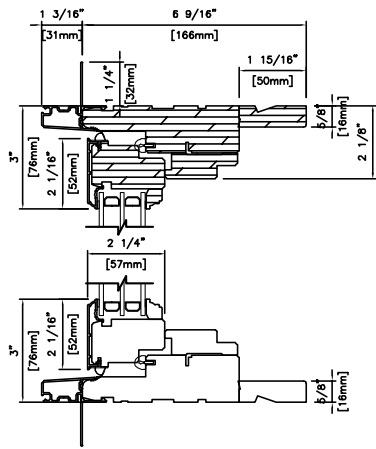

METAL CLAD CASEMENT (TRIPLE GLAZED)
6 9/16" (166mm)
ROTOGEAR MOULDINGS

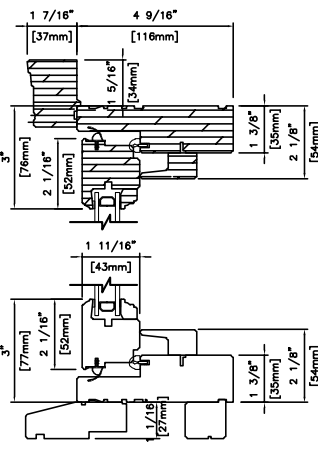

WOOD CASEMENT (DUAL GLAZED)
4 9/16" (116mm)
PUSH OUT MOULDINGS
2" BRICKMOULD WITH STANDARD SUBSILL

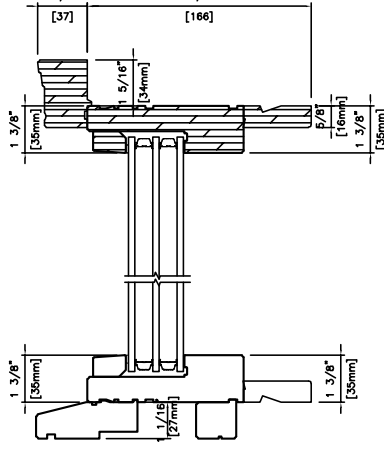

WOOD PICTURE (TRIPLE GLAZED)
6 9/16" (166mm)
2" BRICKMOULD WITH STANDARD SUBSILL

Head & Sill Detail

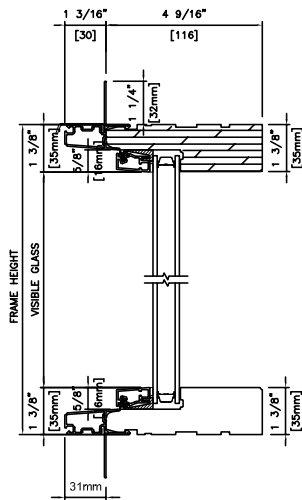

METAL CLAD PICTURE (DUAL GLAZED)
4 9/16" (116mm)

Plan View

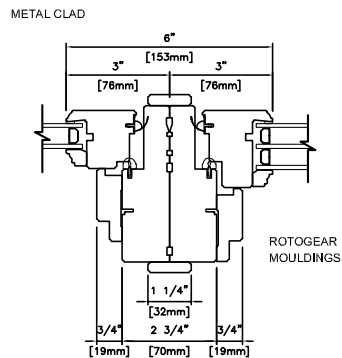
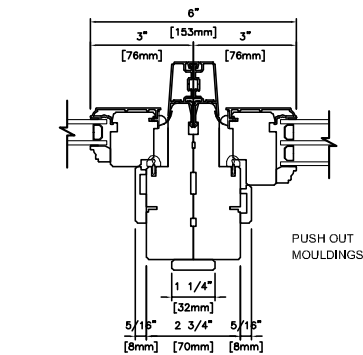

WOOD



RADIUS COMPONENT

- Note:**
- Other jamb widths available.
 - All dimensions to have +/- 1/16" (2mm) tolerance.

