



SWINGING TERRACE & FRENCH TERRACE DOORS

Technical Guide H

FEATURES & SPECIFICATIONS

Styles

Traditional, French, Cambertop, Quarter Round, Full Radius.

Standard Features

Natural Douglas Fir interior (no visible finger joints)

Full Jamb – 6 9/16 (166 mm) construction is an option

3 mm Low E insulated tempered glazing

Multi-point locking hardware, complete with solid brass core handle set, escutcheon and dead bolt

Extruded aluminum cladding in a variety of standard colors, primed wood or clear fir exterior

Flexible weatherstrip system

Hardware

Multiple hardware type and finish choices are available, see the hardware in section A for more information. Multipoint locking hardware – complete with brass handle set and escutcheon – and dead bolt are standard on all Terrace Doors. Optional keyed alike locks are available. Standard concealed bearing hinges in a variety of finishes are available. Note: French doors with handle activated shoot bolts on inactive panel.

Glazing

LowE Double, LowE Triple, and StormForce™. StormForce is not available on all products. Double or triple glass configurations with 1/2" (13 mm) airspace. With countless glazing configurations and LowE coating options, we ensure that you can choose the perfect blend of protection and comfort. LowE best describes the benefits of the product that incorporates glazing coatings and Argon gas. LowE systems help reduce heating and cooling costs, providing superior energy efficiency.

Simulated Divided Lites (SDL)

Standard SDL complete with airspace grilles, where available. Grille bars are permanently applied to the interior and exterior.

Ogee Profile – 3/4" (19 mm), 1 1/8" (30 mm), 2" (51 mm)

Putty Profile – 5/8" (16 mm), 7/8" (22 mm), 1 1/8" (30 mm), 2" (51 mm)

Square Profile (interior only) – 5/8" (16mm), 3/4" (19 mm), 7/8" (22 mm), 1 1/8" (30 mm), 2" (51 mm)



Terrace



French Terrace



Half Round Terrace
Available in wood exterior only.



Half Round French Terrace

FEATURES & SPECIFICATIONS

Casing

Wood: 2" (51 mm) Brickmould, 3 1/2" (89 mm) Flat, 5 1/2" (139 mm) Flat, Adams and Williamsburg.

Metal Clad: 2" (51 mm) Brickmould, 3 1/2" (89 mm) Flat, 2" clad frame extension, Nose & Cove, Adams, Williamsburg and Kerf.

Metal Cladding

Heavy duty exterior metal cladding comprised of extruded aluminum is available in a variety of Palette colors, including anodized and Cyprium (copper and bronze cladding). Metal clad units are supplied ready-to-install complete with integral metal nailing flange.

Wood

In addition to our standard Coastal Douglas Fir, the entire Loewen product line is also available in optional Mahogany. The interior can be natural wood (unfinished), primed, or prefinished in Jet Black or Oxford White paint. Additional wood species, as well as the Jet Black and Oxford White prefinishes, are available through our Custom Shop. All door panels are constructed with a laminated engineered core of Douglas Fir. Alternate species are a thick skin applied over the engineered Douglas Fir core. All wood parts are dipped in approved preservative.

Performance Standards

Most units have been tested by an independent laboratory for air and water infiltration, structural performance, and thermal performance requirements.

Frame & Panel

Manufactured from Coastal Douglas Fir kiln-dried lumber with frame construction designed for 4 9/16" (116 mm) and 6 9/16" (166 mm) jamb. All wood exterior components are factory primed unless specified as clear exterior. Minor scratches or abrasions in the wood surface or primer are not considered defects.

Weatherstrip

High grade weatherstripping runs the full perimeter of the panel/frame interface and provides a tight seal to the exterior elements. Side and head jamb weatherstrip are comprised of a bulb and fin dual seal design.

Door Swings

Traditional Terrace Door: Hinged in the middle so that one panel is fixed, while the other opens/closes. These doors can be configured as a single door, or as a series of fixed, operating, left hinged or right hinged panels.

French Terrace Doors are hinged on the jambs to allow both doors to open/close from the middle.

Note: Outswinging versions of both door styles are available as options.

Variables	Swinging Terrace	Swinging French Terrace
Function		
Use for Egress		●
Multi-point Hardware		○
Performance		
Low Maintenance Metal Clad Exterior		●
Clear Douglas Fir Exterior Finish		○
Clear Mahogany Exterior Finish		○
Primed Exterior Finish		
Cyprum Collection		

Standard ● Optional ○

Variables	Swinging Terrace	Swinging French Terrace
Performance		
LowE Double		●
LowE Triple		○
StormForce™		○
Appearance		
SDL		○
Vertical Grain Fir Panel		

Visit the Loewen Photo Gallery online at www.loewen.com for a large collection of Loewen product and elevation photography.

Numerous custom window configuration opportunities exist – please contact your Authorized Loewen Dealer.

Specifications and technical information are subject to change without notice. Imperial and metric measurements are converted accurately. However, in some cases, industry standards cause a 1 mm variance. (Example: 3/4" is shown as 19 mm for all glass measurements.) Cad Download: www.loewen.com/architect | Installation Instructions: www.loewen.com

Loewen Narrow Stile Terrace Door

Features

Narrower stiles and rails compared to standard Terrace Door panels

Incorporates standard Terrace Door frame and sill

Available as inswing, outswing, and fixed Terrace Doors

Available for BiFold

Metal Clad only in all current finishes with the exception of Cyprum

Not available in shaped units, rectangle only



Sizes

Maximum sizes for a single Terrace Door (TD1) is a width of 36" (924mm) and a height of 106 5/16" (2700mm) or a width of 40 5/16" (1024mm) and a height of 94 1/2" (2400mm)

- Rough Opening and OSM remains the same as a standard Terrace Door, refer to TD1-0927 and TD1-1024 in the Loewen Technical Guide

Maximum sizes for a French Door (FD2) is a width of 72" (1829mm) and a height of 106 5/16" (2700mm) or a width of 79" (2029mm) and a height of 94 1/2" (2400mm)

- Rough Opening and OSM remains the same as a standard Terrace Door, refer to FD2-1827 and FD2-2024 in the Loewen Technical Guide



Options

Optional 7" bottom rail to align with other Terrace Door / French Door units on the job

Ogee, Putty, Square interior glazing stops are all available along with complementary SDL bars

All current Terrace Door handle sets are available, including the new Dallas handle set



Out-Swing



In-Swing

Loewen Outswing 2.25” Terrace Door

New Thicker Panel

Loewen Windows and Doors is pleased to introduce our newest addition to the swinging door Family of products, the 2 1/4” Door. This new option of door has been designed to meet the demands of the luxury market. The thicker, more robust panel provides the valued element of mass which equates to a higher quality experience while using the product. The narrow stile elevation along with the new thicker panel makes for a great contemporary design solution.

Simple Design, Elaborate Performance

Minimal 3” profile and high-performance triple glazing.

Our 2 1/4” door brings with it a new level of robust design that you can hear and feel.

Triple glazing is easily executed giving you better thermal and sound performance. However, one can’t overlook the simple benefits of interacting with a door this substantial. You can see the strength before you lay a hand on it. However, feeling the weight, hearing the contact of door to frame is the real experience.

Features

All of the below features are available or remain unaffected from the standard (1 3/4”) Terrace Door.

Wood Type (Vertical Grain Douglas Fir or Mahogany)

Glazing, Glazing Stop, and SDL Options

Architectural Casings

Hardware

Standard Frame sizes and size limitations

Composite splash guard



Specifications

Panel is a 2 3/8” thick rabbeted panel

Allows for “True Triple” high performance glazing with 1/2” airspace

Standard configuration - stile (4 5/16”) and bottom rail (7 7/8”)

Optional 3” narrow stile configuration - stile (3”) and bottom rail (4 5/16”)

Optional ADA flat sill with 10” tall bottom rail

Optional midrail and both flat and raised panels

Fixed Sidelites only

Sightlines of transom will align with door below
 – Transom sash and door panel align - are on the same plane.

Performance Data

All NFRC as well as NAFS (Air/Water/Structural) performance values remain consistent with existing 1 3/4” product option.

Impact performance and certification remains unchanged from the existing 1 3/4” product option.

Loewen Screen & Storm Doors to Compliment Swinging Doors

Our premium swinging screen door complements our line of Swinging Terrace and French Doors. The screen door can be ordered for clad and all wood doors and is also available as a retrofit into any existing Loewen door frame.

Loewen has taken the functional screen door and designed a robust and clean aesthetic to enhance swinging terrace door entryways.



This is a complete door offering available in all current Loewen clad colors in an AAMA 2605 specification and all anodized finishes to match our doors and frames. Hinge assemblies are also color matched.

The removable standard screen panel is easily replaced with the optional storm panel for increased protection from the elements.

Large sizes are available – up to 3135 mm (123 7/16") tall with screen only option. Narrow stile and rail dimensions of 2 7/8" allow for maximum openings. The strong construction allows the frame to be built without a bottom kick panel.

Loewen Screen & Storm doors can be ordered with any clad or non-clad Swinging Terrace Door. They are also available as a retro-fit for existing Loewen swinging doors.

The screen panel can be removed and replaced with a glass panel for better protection against adverse weather.

Our Screen & Storm doors automatically come with a pair of self-closers. This system includes hold-open functionality.

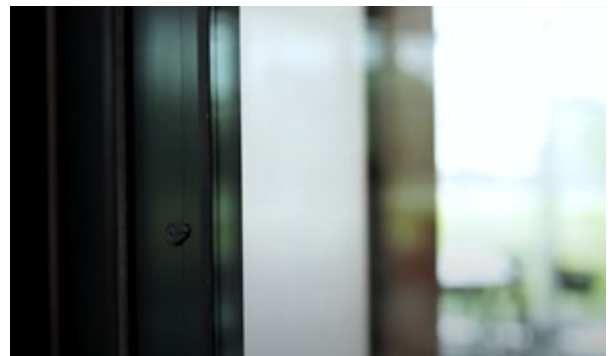

Door Swings

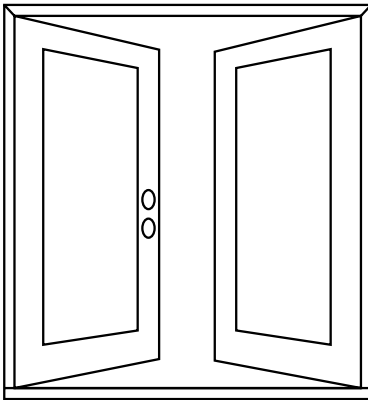

Inswing: LAR (XO)

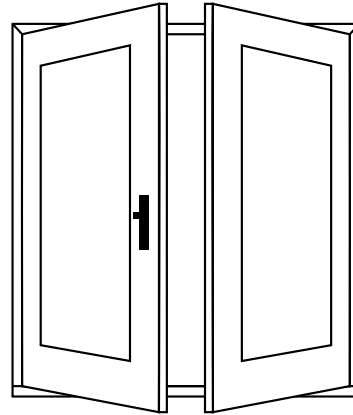

Outswing: LAR (XO)

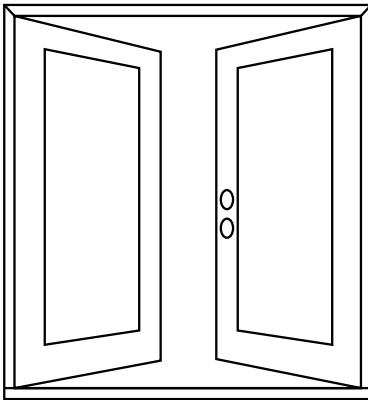

Inswing: LRA (OX)

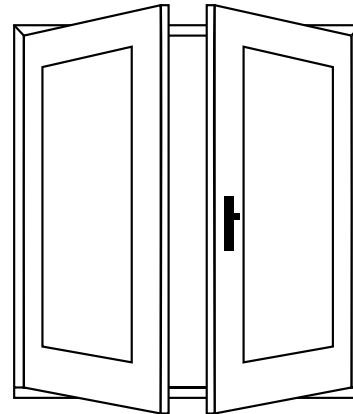

Outswing: LRA (OX)

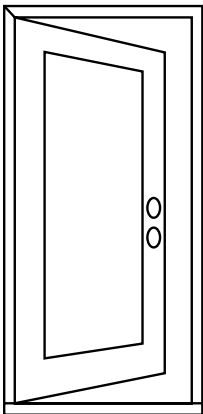

Inswing: LH

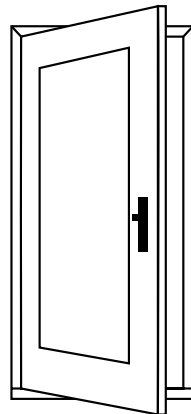

Outswing: LH

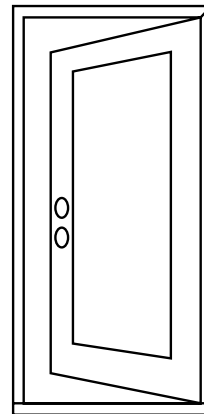

Inswing: RH

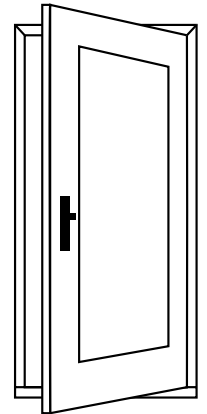

Outswing: RH

Note: Handing is always as if you are viewing the hinge side from the outside of the building regardless of the door swinging into the building or out of the building.

Door Swings

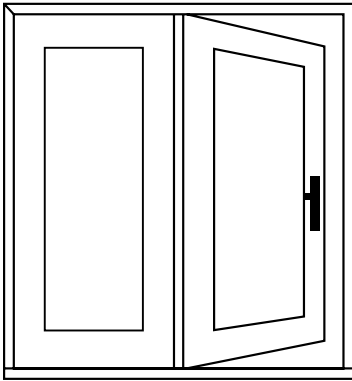

Inswing: Fixed/Left

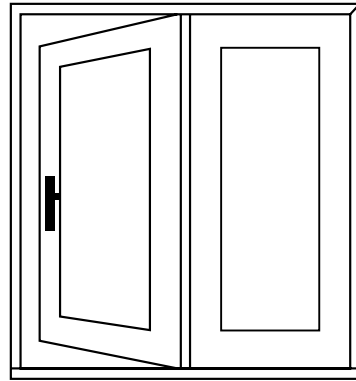

Inswing: Fixed/Right

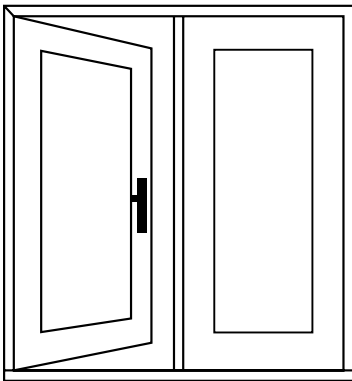

Inswing: Left/Fixed

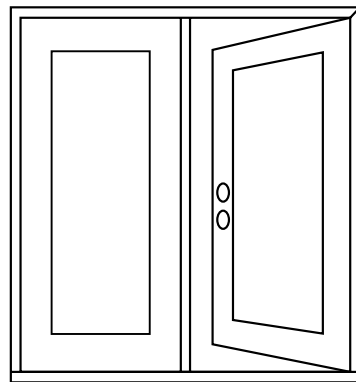

Inswing: Fixed/Right

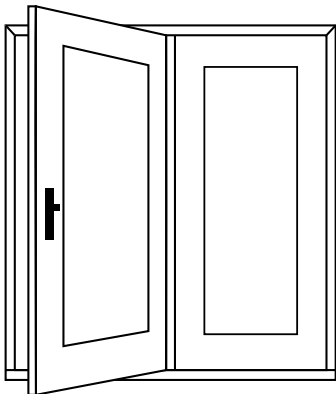

Outswing: Right/Fixed

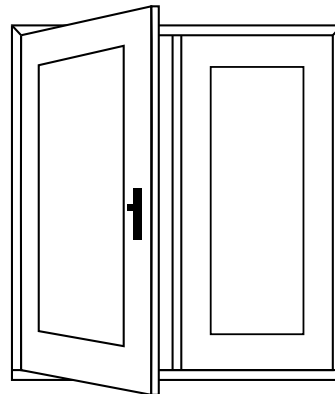

Outswing: Left/Fixed

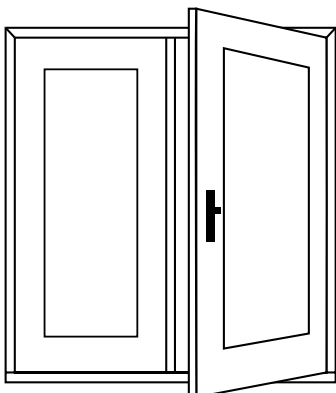

Outswing: Fixed/Right

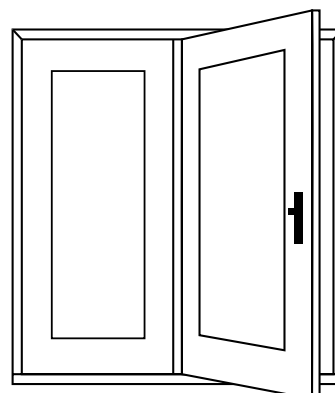

Outswing: Fixed/Left

Swinging Terrace & French Doors -
1.75 Inch - **Narrow Stile (3") TD**

Size Charts

TD1

Width

Height

Rough Opening Inswing with Jamb Extension					19 1/8"	25"	31 7/8"	35 1/8"	37 3/4"	39	41	45 1/4"
					[485]	[635]	[809]	[892]	[959]	5/16" [999]	11/16" [1059]	[1150]
Rough Opening					18 7/16"	24 3/8"	31 1/4"	34 1/2"	37 1/8"	38	41 1/16"	44 5/8"
					[469]	[619]	[793]	[876]	[943]	11/16" [983]	[1043]	[1134]
Frame					17	23 5/8"	30 1/2"	33 3/4"	36 3/8"	37	40	43 7/8"
					11/16" [450]	[600]	[774]	[857]	[924]	15/16" [964]	5/16" [1024]	[1115]
Panel					15	21 3/4"	28	31 7/8"	34 1/2"	36	38	42"
					13/16" [402]	[552]	9/16" [726]	[809]	[876]	1/16" [916]	7/16" [976]	[1067]
Visible Glass					9	15	22	25	28	27 3/8"	32 1/2"	33 3/8"
					15/16" [252]	13/16" [402]	11/16" [576]	15/16" [659]	9/16" [726]	27 3/8" [696]	32 1/2" [826]	33 3/8" [847]
16 5/8" [422]	16 5/16" [415]	15 3/4" [400]	13 7/8" [352]	9 11/16" [246]	* TDT1 0404	*TDT1 0604	*TDT1 0704	* TDT1 0804	* TDT1 0904	* TDT1 0904	*TDT1 1004	*TDT1 1104
24 1/2" [622]	24 3/16" [615]	23 5/8" [600]	21 3/4" [552]	17 9/16" [446]	* TDT1 0406	* TDT1 0606	*TDT1 0706	*TDT1 0806	* TDT1 0906	* TDT1 0906	* TDT1 1006	* TDT1 1106
					VENTING SUITE			DOORS				
80 3/8" [2042]	80 1/8" [2035]	79 1/2" [2020]	76 7/16" [1942]	68 13/16" [1748]	~TD1 0420	~TD1 0620	TD1 0720	TD1 0820	TD1 0920	TD1 0920	TD1 1020	TD1 1120
82 3/16" [2087]	81 7/8" [2080]	81 5/16" [2065]	78 1/4" [1987]	70 9/16" [1793]	~TD1 0421	~TD1 0621	TD1 0721	TD1 0821	TD1 0921	TD1 0921	TD1 1021	TD1 1121
86 7/8" [2206]	86 9/16" [2199]	86" [2184]	82 15/16" [2106]	75 1/4" [1912]	~TD1 0470	~TD1 0670	TD1 0770	TD1 0870	TD1 0970	TD1 0970	TD1 1070	TD1 1170
95 3/8" [2422]	95 1/16" [2415]	94 1/2" [2400]	91 7/16" [2322]	83 3/4" [2128]	~TD1 0424	~TD1 0624	TD1 0724	TD1 0824	TD1 0924	TD1 0924	TD1 1024	TD1 1124
98 1/4" [2496]	98" [2489]	97 3/8" [2474]	94 5/16" [2396]	86 11/16" [2202]	~TD1 0480	~TD1 0680	TD1 0780	TD1 0880	TD1 0980	TD1 0980	TD1 1080	TD1 1180
99 15/16" [2538]	99 5/8" [2531]	99 1/16" [2516]	96" [2438]	88 3/8" [2244]	~TD1 0425	~TD1 0625	TD1 0725	TD1 0825	TD1 0925	TD1 0925	TD1 1025	TD1 1125
107 3/16 [2722]	106 7/8" [2715]	106 5/16" [2700]	103 1/4" [2622]	95 9/16" [2428]	~TD1 0427	~TD1 0627	TD1 0727	TD1 0827	TD1 0927	TD1 0927	TD1 1027	TD1 1127

* Transom units
~ Venting or Fixed Sidelite

Swinging Terrace & French Doors -
1.75 Inch - **Narrow Stile (3") TD**

Size Charts

TD2

					Width							
Rough Opening Inswing with Jamb Extension					46 3/4" [1187]	60 7/16" [1535]	66 15/16" [1701]	72 1/4" [1835]	75 3/8" [1915]	80 1/8" [2035]	87 5/16" [2217]	
Rough Opening					46 1/8" [1171]	59 13/16" [1519]	66 5/16" [1685]	71 5/8" [1819]	74 3/4" [1899]	79 1/2" [2019]	86 5/8" [2201]	
Frame					45 3/8" [1152]	59 1/16" [1500]	65 9/16" [1666]	70 7/8" [1800]	70 7/8" [1880]	78 3/4" [2000]	85 7/8" [2182]	
Panel					21 3/4" [552]	28 9/16" [726]	31 7/8" [809]	34 1/2" [876]	36 1/16" [916]	38 7/16" [976]	42" [1067]	
Visible Glass					15 13/16" [402]	22 11/16" [576]	25 15/16" [659]	28 9/16" [726]	27 3/8" [696]	32 1/2" [826]	33 3/8" [847]	
					TRANSOM							
16 5/8" [422]	16 5/16" [415]	15 3/4" [400]	13 7/8" [352]	9 11/16" [246]	*TDT2 1204	*TDT2 1504	* TDT2 1604	* TDT2 1804	* TDT2 1804	*TDT2 2004	*TDT2 2204	
24 1/2" [622]	24 3/16" [615]	23 5/8" [600]	21 3/4" [552]	17 9/16" [446]	*TDT2 1206	*TDT2 1506	*TDT2 1606	* TDT2 1806	* TDT2 1806	* TDT2 2006	* TDT2 2206	
					DOOR							
80 3/8" [2042]	80 1/8" [2035]	79 1/2" [2020]	76 7/16" [1942]	68 13/16" [1748]	TD2 1220	TD2 1520	TD2 1620	TD2 1820	TD2 1820	TD2 2020	TD2 2220	
82 3/16" [2087]	81 7/8" [2080]	81 5/16" [2065]	78 1/4" [1987]	70 9/16" [1793]	TD2 1221	TD2 1521	TD2 1621	TD2 1821	TD2 1821	TD2 2021	TD2 2221	
86 7/8" [2206]	86 9/16" [2199]	86" [2184]	82 15/16" [2106]	75 1/4" [1912]	TD2 1270	TD2 1570	TD2 1670	TD2 1870	TD2 1870	TD2 2070	TD2 2270	
95 3/8" [2422]	95 1/16" [2415]	94 1/2" [2400]	91 7/16" [2322]	83 3/4" [2128]	TD2 1224	TD2 1524	TD2 1624	TD2 1824	TD2 1824	TD2 2024	TD2 2224	
98 1/4" [2496]	98" [2489]	97 3/8" [2474]	94 5/16" [2396]	86 11/16" [2202]	TD2 1280	TD2 1580	TD2 1680	TD2 1880	TD2 1880	TD2 2080	TD2 2280	
99 15/16" [2538]	99 5/8" [2531]	99 1/16" [2516]	96" [2438]	88 3/8" [2244]	TD2 1225	TD2 1525	TD2 1625	TD2 1825	TD2 1825	TD2 2025	TD2 2225	
107 3/16 [2722]	106 7/8" [2715]	106 5/16" [2700]	103 1/4" [2622]	95 9/16" [2428]	TD2 1227	TD2 1527	TD2 1627	TD2 1827	TD2 1827	TD2 2027	TD2 2227	

* Fixed Sidelite

Swinging Terrace & French Doors -
1.75 Inch - **Narrow Stile (3") TD**

Size Charts

TD3

					Width															
Rough Opening Inswing with Jamb Extension					89" [2261]	98 13/16" [2510]	106 3/4" [2711]	111 7/16" [2831]	118 9/16" [3011]	129 5/16" [3284]										
					Rough Opening					88 3/8" [2245]	98 3/16" [2494]	106 1/16" [2695]	110 13/16" [2815]	117 7/8" [2995]	128 11/16" [3268]					
										Frame					87 5/8" [2226]	97 7/16" [2475]	105 5/16" [2676]	110 1/16" [2796]	117 1/8" [2976]	127 15/16" [3249]
					Panel										28 9/16" [726]	31 7/8" [809]	34 1/2" [876]	36 1/16" [916]	38 7/16" [976]	42" [1067]
															Visible Glass					22 11/16" [576]
					TRANSOM															
16 5/8" [422]	16 5/16" [415]	15 3/4" [400]	13 7/8" [352]	9 11/16" [246]	*TDT3 2204	* TDT3 2404	* TDT3 2704	* TDT3 2704	* TDT3 3004	* TDT3 3204										
24 1/2" [622]	24 3/16" [615]	23 5/8" [600]	21 3/4" [552]	17 9/16" [446]	*TDT3 2206	* TDT3 2406	* TDT3 2706	* TDT3 2706	* TDT3 3006	* TDT3 3206										
					DOOR															
80 3/8" [2042]	80 1/8" [2035]	79 1/2" [2020]	76 7/16" [1942]	68 13/16" [1748]	TD3 2220	TD3 2420	TD3 2720	TD3 2720	TD3 3020	TD3 3220										
82 3/16" [2087]	81 7/8" [2080]	81 5/16" [2065]	78 1/4" [1987]	70 9/16" [1793]	TD3 2221	TD3 2421	TD3 2721	TD3 2721	TD3 3021	TD3 3221										
86 7/8" [2206]	86 9/16" [2199]	86" [2184]	82 15/16" [2106]	75 1/4" [1912]	TD3 2270	TD3 2470	TD3 2770	TD3 2770	TD3 3070	TD3 3270										
95 3/8" [2422]	95 1/16" [2415]	94 1/2" [2400]	91 7/16" [2322]	83 3/4" [2128]	TD3 2224	TD3 2424	TD3 2724	TD3 2724	TD3 3024	TD3 3224										
98 1/4" [2496]	98" [2489]	97 3/8" [2474]	94 5/16" [2396]	86 11/16" [2202]	TD3 2280	TD3 2480	TD3 2780	TD3 2780	TD3 3080	TD3 3280										
99 15/16" [2538]	99 5/8" [2531]	99 1/16" [2516]	96" [2438]	88 3/8" [2244]	TD3 2225	TD3 2425	TD3 2725	TD3 2725	TD3 3025	TD3 3225										
107 3/16 [2722]	106 7/8" [2715]	106 5/16" [2700]	103 1/4" [2622]	95 9/16" [2428]	TD3 2227	TD3 2427	TD3 2727	TD3 2727	TD3 3027	TD3 3227										

* Fixed Sidelite

Swinging Terrace & French Doors -
1.75 Inch - **Narrow Stile (3") TD**

Size Charts

TD4

Width

Height

Rough Opening Inswing with Jamb Extension					111 7/16" [2831]	117 5/8" [2988]	130 11/16" [3320]	141 1/4" [3588]	147 1/2" [3747]	157" [3988]	171 5/16" [4352]					
					Rough Opening					110 13/16" [2815]	117" [2972]	130 1/16" [3304]	140 5/8" [3572]	146 7/8" [3731]	156 3/8" [3972]	170 11/16" [4336]
					Frame					110 1/16" [2796]	116 1/4" [2953]	129 5/16" [3285]	139 7/8" [3553]	146 1/8" [3712]	155 5/8" [3953]	169 15/16" [4317]
					Panel					27 1/16" [687]	28 9/16" [726]	31 7/8" [809]	34 1/2" [876]	36 1/16" [916]	38 7/16" [976]	42" [1067]
					Visible Glass					21 1/8" [537]	22 11/16" [576]	25 15/16" [659]	28 9/16" [726]	27 3/8" [696]	32 1/2" [826]	33 3/8" [847]
					TRANSOM											
16 5/8" [422]	16 5/16" [415]	15 3/4" [400]	13 7/8" [352]	9 11/16" [246]	*TDT4 2704	*TDT4 3004	*TDT4 3204	*TDT4 3604	*TDT4 3604	*TDT4 4004	*TDT4 4304					
24 1/2" [622]	24 3/16" [615]	23 5/8" [600]	21 3/4" [552]	17 9/16" [446]	*TDT4 2706	*TDT4 3006	*TDT4 3206	*TDT4 3606	*TDT4 3606	*TDT4 4006	*TDT4 4306					
					DOOR											
80 3/8" [2042]	80 1/8" [2035]	79 1/2" [2020]	76 7/16" [1942]	68 13/16" [1748]	TD4 2720	TD4 3020	TD4 3220	TD4 3620	TD4 3620	TD4 4020	TD4 4320					
82 3/16" [2087]	81 7/8" [2080]	81 5/16" [2065]	78 1/4" [1987]	70 9/16" [1793]	TD4 2721	TD4 3021	TD4 3221	TD4 3621	TD4 3621	TD4 4021	TD4 4321					
86 7/8" [2206]	86 9/16" [2199]	86" [2184]	82 15/16" [2106]	75 1/4" [1912]	TD4 2770	TD4 3070	TD4 3270	TD4 3670	TD4 3670	TD4 4070	TD4 4370					
95 3/8" [2422]	95 1/16" [2415]	94 1/2" [2400]	91 7/16" [2322]	83 3/4" [2128]	TD4 2724	TD4 3024	TD4 3224	TD4 3624	TD4 3624	TD4 4024	TD4 4324					
98 1/4" [2496]	98" [2489]	97 3/8" [2474]	94 5/16" [2396]	86 11/16" [2202]	TD4 2780	TD4 3080	TD4 3280	TD4 3680	TD4 3680	TD4 4080	TD4 4380					
99 15/16" [2538]	99 5/8" [2531]	99 1/16" [2516]	96" [2438]	88 3/8" [2244]	TD4 2725	TD4 3025	TD4 3225	TD4 3625	TD4 3625	TD4 4025	TD4 4325					
107 3/16 [2722]	106 7/8" [2715]	106 5/16" [2700]	103 1/4" [2622]	95 9/16" [2428]	TD4 2727	TD4 3027	TD4 3227	TD4 3627	TD4 3627	TD4 4027	TD4 4327					

* Fixed Sidelite

Swinging Terrace & French Doors -
1.75 Inch - **Narrow Stile (3") TD**

Drawings

Inswing

HEAD & SILL DETAIL

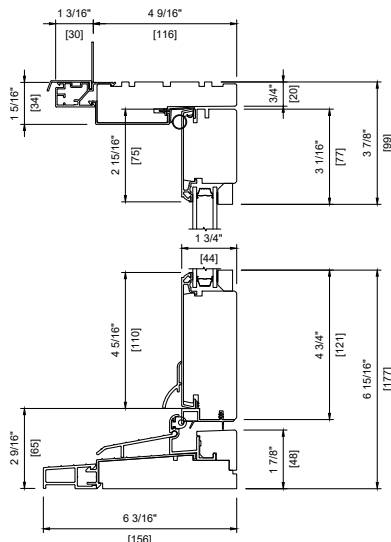

METAL CLAD DOUBLE
4 $\frac{3}{8}$ " (116 mm)

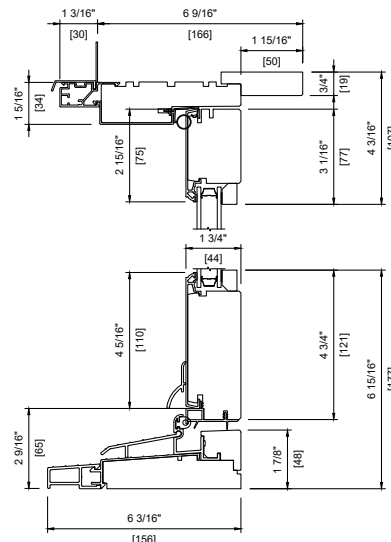

METAL CLAD DOUBLE
6 $\frac{5}{8}$ " (166 mm)

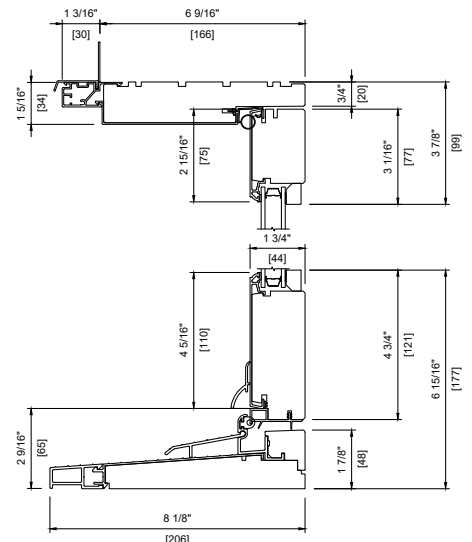

METAL CLAD DOUBLE
6 $\frac{5}{8}$ " (166 mm)
FULL JAMB

PLAN VIEW

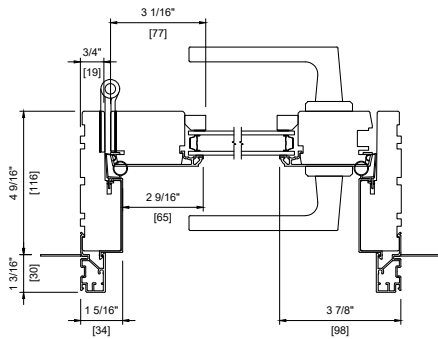

METAL CLAD DOUBLE
ONE PANEL
4 $\frac{3}{8}$ " (116 mm)

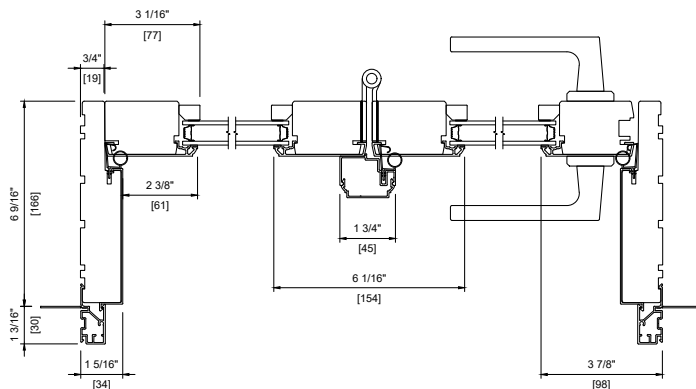

METAL CLAD DOUBLE
TWO PANEL
6 $\frac{5}{8}$ " (166 mm)

GLAZING STOP PROFILES

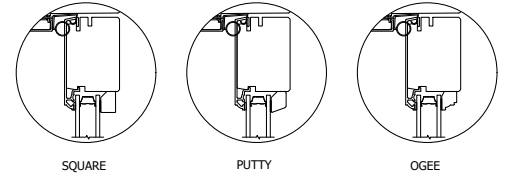

Casing

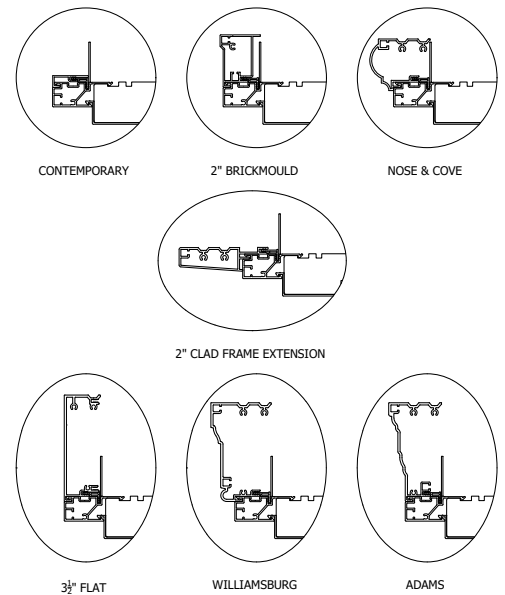

Swinging Terrace & French Doors -
1.75 Inch - **Narrow Stile (3") TD**

Drawings

Outswing

HEAD & SILL DETAIL

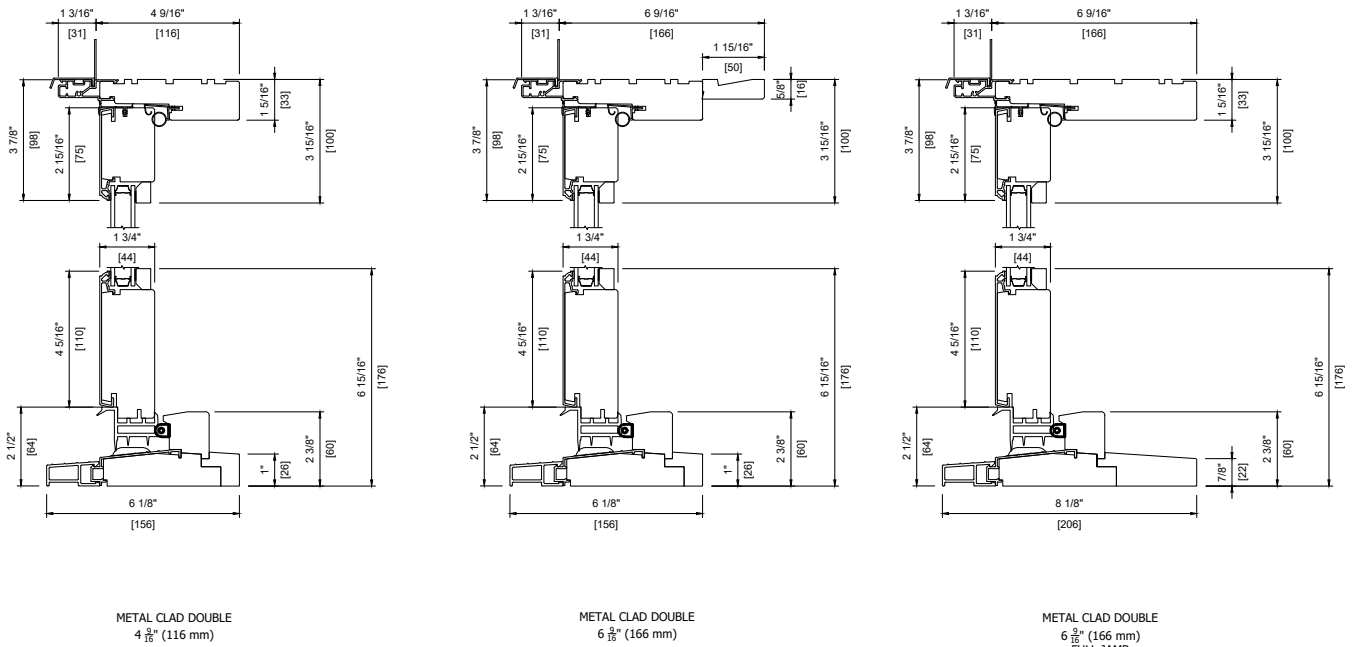

PLAN VIEW

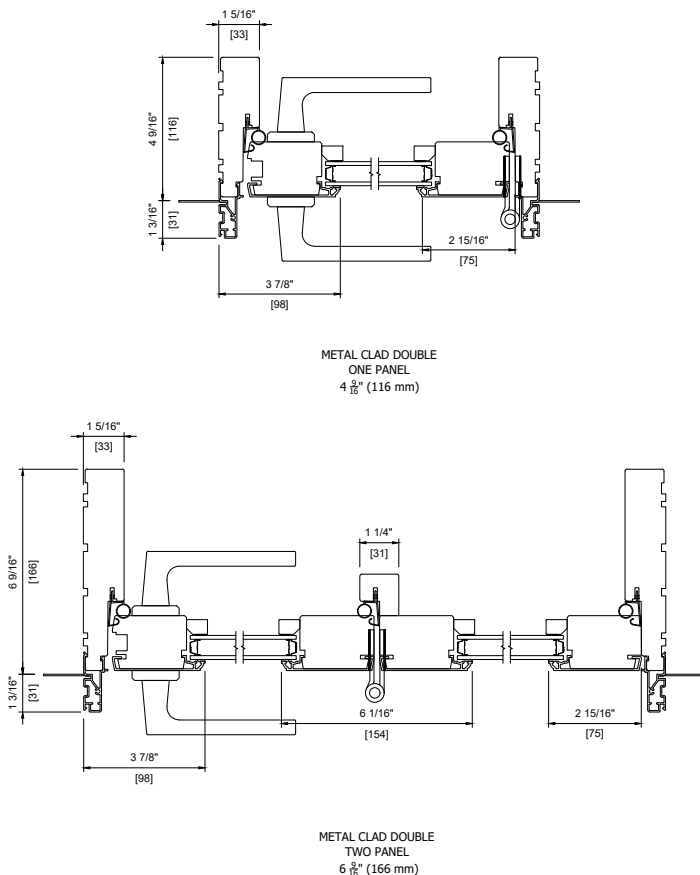

GLAZING STOP PROFILES

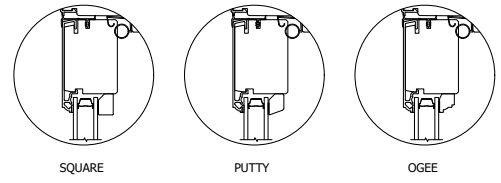

Casing

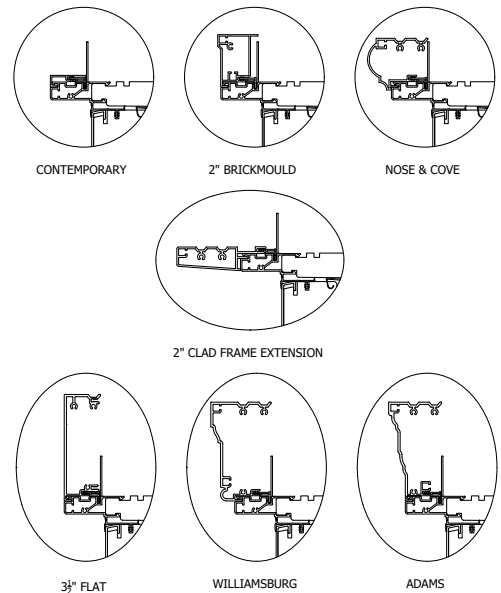

Swinging Terrace & French Doors -
1.75 Inch - **Narrow Stile (3") TD**

Drawings

3 & 4 Wide Inswing & Outswing

PLAN VIEW
INSWING

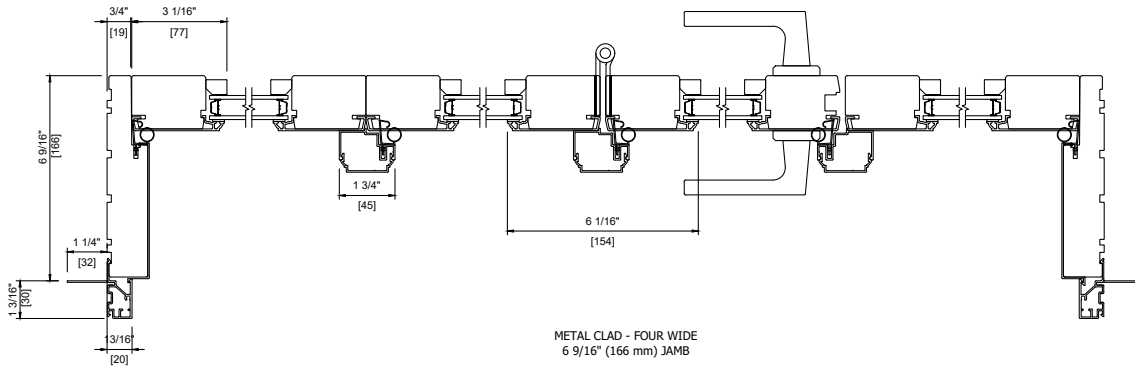
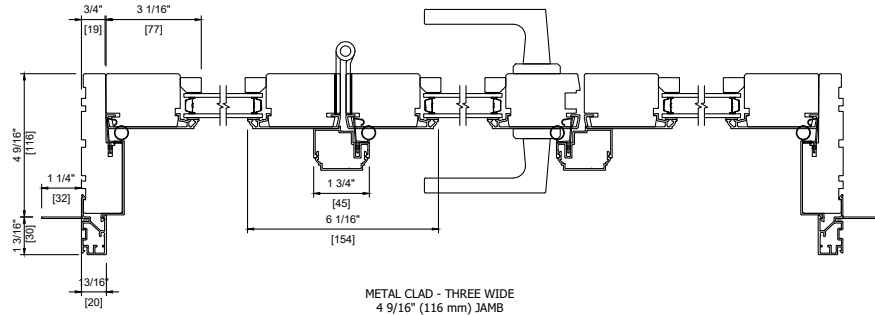

PLAN VIEW
OUTSWING

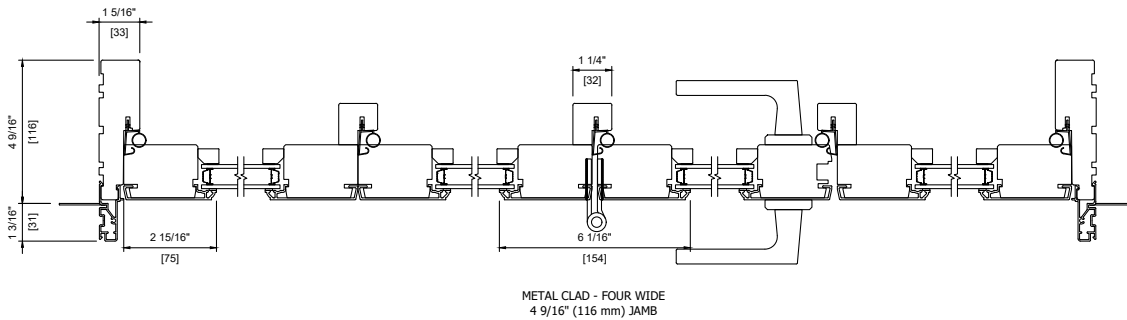
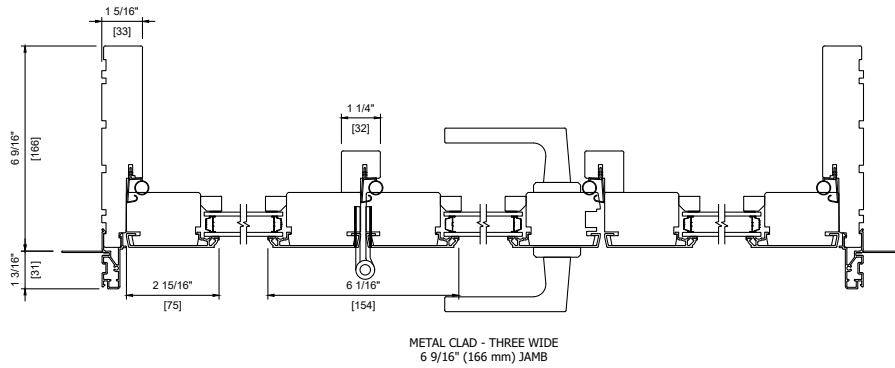

Swinging Terrace & French Doors -
1.75 Inch - **Standard Stile (>3") TD**

Size Charts

TD1

Width

Rough Opening Inswing with Jamb Extension					19 1/8"	25"	31 7/8"	35 1/8"	37 3/4"	39	41	45 1/4"				
					Rough Opening		18	24 3/8"	31 1/4"	34 1/2"	37 1/8"	38	41	44 5/8"		
					Frame			17	23 5/8"	30 1/2"	33 3/4"	36 3/8"	37	40	43 7/8"	
					Panel				15	21 3/4"	28	31 7/8"	34 1/2"	36	38	42"
					Visible Glass					7 3/16"	13	19	23	25	27 3/8"	29 3/4"
					TRANSOM											
16 5/8"	16 5/16"	15 3/4"	13 7/8"	9 11/16"	*TDT1 0404	*TDT1 0604	*TDT1 0704	*TDT1 0804	*TDT1 0904	*TDT1 0904	*TDT1 1004	*TDT1 1104				
24 1/2"	24 3/16"	23 5/8"	21 3/4"	17 9/16"	*TDT1 0406	*TDT1 0606	*TDT1 0706	*TDT1 0806	*TDT1 0906	*TDT1 0906	*TDT1 1006	*TDT1 1106				
					VENTING SUITE		DOORS									
80 3/8"	80 1/8"	79 1/2"	76 7/16"	63 7/8"	^VTD1 0420	^VTD1 0620	TD1 0720	TD1 0820	TD1 0920	TD1 0920	TD1 1020	TD1 1120				
82 3/16"	81 7/8"	81 5/16"	78 1/4"	65 11/16"	^VTD1 0421	^VTD1 0621	TD1 0721	TD1 0821	TD1 0921	TD1 0921	TD1 1021	TD1 1121				
86 7/8"	86 9/16"	86"	82 15/16"	70 3/8"	^VTD1 0470	^VTD1 0670	TD1 0770	TD1 0870	TD1 0970	TD1 0970	TD1 1070	TD1 1170				
95 3/8"	95 1/16"	94 1/2"	91 7/16"	78 7/8"	^VTD1 0424	^VTD1 0624	TD1 0724	TD1 0824	TD1 0924	TD1 0924	TD1 1024	TD1 1124				
98 1/4"	98"	97 3/8"	94 5/16"	81 3/4"	^VTD1 0480	^VTD1 0680	TD1 0780	TD1 0880	TD1 0980	TD1 0980	TD1 1080	TD1 1180				
99 15/16"	99 5/8"	99 1/16"	96"	83 7/16"	^VTD1 0425	^VTD1 0625	TD1 0725	TD1 0825	TD1 0925	TD1 0925	TD1 1025	TD1 1125				
107 3/16"	106 7/8"	106 5/16"	103 1/4"	90 11/16"			TD1 0727	TD1 0827	TD1 0927	TD1 0927	TD1 1027	TD1 1127				
124 5/16"	124"	123 7/16"	120 3/8"	107 13/16"			TD1 0732	TD1 0832	TD1 0932	TD1 0932	TD1 1032					

Height

* Transom units
^ Venting or fixed

Swinging Terrace & French Doors -
1.75 Inch - **Standard Stile (>3") TD**

Size Charts

TD2

Width

Height

Rough Opening Inswing with Jamb Extension					46 3/4" [1187]	60 7/16" [1535]	66 15/16" [1701]	72 1/4" [1835]	75 3/8" [1915]	80 1/8" [2035]	87 5/16" [2217]
Rough Opening					46 1/8" [1171]	59 13/16" [1519]	66 5/16" [1685]	71 5/8" [1819]	74 3/4" [1899]	79 1/2" [2019]	86 5/8" [2201]
Frame					45 3/8" [1152]	59 1/16" [1500]	65 9/16" [1666]	70 7/8" [1800]	70 7/8" [1880]	78 3/4" [2000]	85 7/8" [2182]
Panel					21 3/4" [552]	28 9/16" [726]	31 7/8" [809]	34 1/2" [876]	36 1/16" [916]	38 7/16" [976]	42" [1067]
Visible Glass					13 1/16" [332]	19 15/16" [506]	23 3/16" [589]	25 13/16" [656]	27 3/8" [696]	29 3/4" [756]	33 3/8" [847]
					TRANSOM						
16 5/8" [422]	16 5/16" [415]	15 3/4" [400]	13 7/8" [352]	9 11/16" [246]	*TDT2 1204	*TDT2 1504	*TDT2 1604	*TDT2 1804	*TDT2 1804	*TDT2 2004	*TDT2 2204
24 1/2" [622]	24 3/16" [615]	23 5/8" [600]	21 3/4" [552]	17 9/16" [446]	*TDT2 1206	*TDT2 1506	*TDT2 1606	*TDT2 1806	*TDT2 1806	*TDT2 2006	*TDT2 2206
					DOORS						
80 3/8" [2042]	80 1/8" [2035]	79 1/2" [2020]	76 7/16" [1942]	63 7/8" [1623]	TD2 1220	TD2 1520	TD2 1620	TD2 1820	TD2 1820	TD2 2020	TD2 2220
82 3/16" [2087]	81 7/8" [2080]	81 5/16" [2065]	78 1/4" [1987]	65 11/16" [1668]	TD2 1221	TD2 1521	TD2 1621	TD2 1821	TD2 1821	TD2 2021	TD2 2221
86 7/8" [2206]	86 9/16" [2199]	86" [2184]	82 15/16" [2106]	70 3/8" [1787]	TD2 1270	TD2 1570	TD2 1670	TD2 1870	TD2 1870	TD2 2070	TD2 2270
95 3/8" [2422]	95 1/16" [2415]	94 1/2" [2400]	91 7/16" [2322]	78 7/8" [2003]	TD2 1224	TD2 1524	TD2 1624	TD2 1824	TD2 1824	TD2 2024	TD2 2224
98 1/4" [2496]	98" [2489]	97 3/8" [2474]	94 5/16" [2396]	81 3/4" [2077]	TD2 1280	TD2 1580	TD2 1680	TD2 1880	TD2 1880	TD2 2080	TD2 2280
99 15/16" [2538]	99 5/8" [2531]	99 1/16" [2516]	96" [2438]	83 7/16" [2119]	TD2 1225	TD2 1525	TD2 1625	TD2 1825	TD2 1825	TD2 2025	TD2 2225
107 3/16 [2722]	106 7/8" [2715]	106 5/16" [2700]	103 1/4" [2622]	90 11/16" [2303]	TD2 1227	TD2 1527	TD2 1627	TD2 1827	TD2 1827	TD2 2027	TD2 2227
124 5/16 [3157]	124" [3150]	123 7/16" [3135]	120 3/8" [3057]	107 13/16" [2738]	TD2 1232	TD2 1532	TD2 1632	TD2 1832	TD2 1832	TD2 2032	

* Transom units

Swinging Terrace & French Doors -
1.75 Inch - **Standard Stile (>3") TD**

Size Charts

TD3

Width

Height

Rough Opening Inswing with Jamb Extension					89" [2261]	98 13/16" [2510]	106 3/4" [2711]	111 7/16" [2831]	118 9/16" [3011]	129 5/16" [3284]
Rough Opening					88 3/8" [2245]	98 3/16" [2494]	106 1/16" [2695]	110 13/16" [2815]	117 7/8" [2995]	128 11/16" [3268]
Frame					87 5/8" [2226]	97 7/16" [2475]	105 5/16" [2676]	110 1/16" [2796]	117 1/8" [2976]	127 15/16" [3249]
Panel					28 9/16" [726]	31 7/8" [809]	34 1/2" [876]	36 1/16" [916]	38 7/16" [976]	42" [1067]
Visible Glass					19 15/16" [506]	23 3/16" [589]	25 13/16" [656]	27 3/8" [696]	29 3/4" [756]	33 3/8" [847]
					TRANSOM					
16 5/8" [422]	16 5/16" [415]	15 3/4" [400]	13 7/8" [352]	9 11/16" [246]	*TDT3 2204	*TDT3 2404	*TDT3 2704	*TDT3 2704	*TDT3 3004	*TDT3 3204
24 1/2" [622]	24 3/16" [615]	23 5/8" [600]	21 3/4" [552]	17 9/16" [446]	*TDT3 2206	*TDT3 2406	*TDT3 2706	*TDT3 2706	*TDT3 3006	*TDT3 3206
					DOORS					
80 3/8" [2042]	80 1/8" [2035]	79 1/2" [2020]	76 7/16" [1942]	63 7/8" [1623]	TD3 2220	TD3 2420	TD3 2720	TD3 2720	TD3 3020	TD3 3220
82 3/16" [2087]	81 7/8" [2080]	81 5/16" [2065]	78 1/4" [1987]	65 11/16" [1668]	TD3 2221	TD3 2421	TD3 2721	TD3 2721	TD3 3021	TD3 3221
86 7/8" [2206]	86 9/16" [2199]	86" [2184]	82 15/16" [2106]	70 3/8" [1787]	TD3 2270	TD3 2470	TD3 2770	TD3 2770	TD3 3070	TD3 3270
95 3/8" [2422]	95 1/16" [2415]	94 1/2" [2400]	91 7/16" [2322]	78 7/8" [2003]	TD3 2224	TD3 2424	TD3 2724	TD3 2724	TD3 3024	TD3 3224
98 1/4" [2496]	98" [2489]	97 3/8" [2474]	94 5/16" [2396]	81 3/4" [2077]	TD3 2280	TD3 2480	TD3 2780	TD3 2780	TD3 3080	TD3 3280
99 15/16" [2538]	99 5/8" [2531]	99 1/16" [2516]	96" [2438]	83 7/16" [2119]	TD3 2225	TD3 2425	TD3 2725	TD3 2725	TD3 3025	TD3 3225
107 3/16" [2722]	106 7/8" [2715]	106 5/16" [2700]	103 1/4" [2622]	90 11/16" [2303]	TD3 2227	TD3 2427	TD3 2727	TD3 2727	TD3 3027	TD3 3227

* Transom units

Swinging Terrace & French Doors -
1.75 Inch - **Standard Stile (>3") TD**

Size Charts

TD4

Width

Rough Opening Inswing with Jamb Extension					117 5/8" [2988]	130 11/16" [3320]	141 1/4" [3588]	147 1/2" [3747]	157" [3988]	171 5/16" [4352]					
					Rough Opening					117" [2972]	130 1/16" [3304]	140 5/8" [3572]	146 7/8" [3731]	156 3/8" [3972]	170 11/16" [4336]
					Frame					116 1/4" [2953]	129 5/16" [3285]	139 7/8" [3553]	146 1/8" [3712]	155 5/8" [3953]	169 15/16" [4317]
					Panel					28 9/16" [726]	31 7/8" [809]	34 1/2" [876]	36 1/16" [916]	38 7/16" [976]	42" [1067]
					Visible Glass					19 15/16" [506]	23 3/16" [589]	25 13/16" [656]	27 3/8" [696]	29 3/4" [756]	33 3/8" [847]
					TRANSOM										
16 5/8" [422]	16 5/16" [415]	15 3/4" [400]	13 7/8" [352]	9 11/16" [246]	*TDT4 3004	*TDT4 3204	*TDT4 3604	*TDT4 3604	*TDT4 4004	*TDT4 4304					
24 1/2" [622]	24 3/16" [615]	23 5/8" [600]	21 3/4" [552]	17 9/16" [446]	*TDT4 3006	*TDT4 3206	*TDT4 3606	*TDT4 3606	*TDT4 4006	*TDT4 4306					
					DOORS										
80 3/8" [2042]	80 1/8" [2035]	79 1/2" [2020]	76 7/16" [1942]	63 7/8" [1623]	TD4 3020	TD4 3220	TD4 3620	TD4 3620	TD4 4020	TD4 4320					
82 3/16" [2087]	81 7/8" [2080]	81 5/16" [2065]	78 1/4" [1987]	65 11/16" [1668]	TD4 3021	TD4 3221	TD4 3621	TD4 3621	TD4 4021	TD4 4321					
86 7/8" [2206]	86 9/16" [2199]	86" [2184]	82 15/16" [2106]	70 3/8" [1787]	TD4 3070	TD4 3270	TD4 3670	TD4 3670	TD4 4070	TD4 4370					
95 3/8" [2422]	95 1/16" [2415]	94 1/2" [2400]	91 7/16" [2322]	78 7/8" [2003]	TD4 3024	TD4 3224	TD4 3624	TD4 3624	TD4 4024	TD4 4324					
98 1/4" [2496]	98" [2489]	97 3/8" [2474]	94 5/16" [2396]	81 3/4" [2077]	TD4 3080	TD4 3280	TD4 3680	TD4 3680	TD4 4080	TD4 4380					
99 15/16" [2538]	99 5/8" [2531]	99 1/16" [2516]	96" [2438]	83 7/16" [2119]	TD4 3025	TD4 3225	TD4 3625	TD4 3625	TD4 4025	TD4 4325					
107 3/16 [2722]	106 7/8" [2715]	106 5/16" [2700]	103 1/4" [2622]	90 11/16" [2303]	TD4 3027	TD4 3227	TD4 3627	TD4 3627	TD4 4027	TD4 4327					

Height

* Transom units

Swinging Terrace & French Doors -
1.75 Inch - **Standard Stile (>3") TD**

Size Charts

Cambertop TD1

Width

		Rough Opening Inswing with Jamb Extension				31 7/8" [809]	35 1/82" [892]	37 3/4" [959]	39 5/16" [999]	41 11/16" [1059]	45 1/4" [1150]	
		Rough Opening					31 1/4" [793]	34 1/2" [876]	37 1/8" [943]	38 11/16" [983]	41 1/16" [1043]	44 5/8" [1134]
		Frame					30 1/2" [774]	33 3/4" [857]	36 3/8" [924]	37 15/16" [964]	40 5/16" [1024]	43 7/8" [1115]
		Panel					28 9/16" [726]	31 7/8" [809]	34 1/2" [876]	36 1/16" [916]	38 7/16" [976]	42" [1067]
		Visible Glass					19 15/16" [506]	23 3/16" [589]	25 13/16" [656]	27 3/8" [696]	29 3/4" [756]	33 3/8" [847]
Height	80 3/8" [2042]	80 1/8" [2035]	79 1/2" [2020]	76 7/16" [1942]	63 15/16" [1624]	CTTD1 0720	CTTD1 0820	CTTD1 0920	CTTD1 0920	CTTD1 1020	CTTD1 1120	
	82 3/16" [2087]	81 7/8" [2080]	81 5/16" [2065]	78 1/4" [1987]	65 11/16" [1668]	CTTD1 0721	CTTD1 0821	CTTD1 0921	CTTD1 0921	CTTD1 1021	CTTD1 1121	
	86 7/8" [2206]	86 9/16" [2199]	86" [2184]	82 15/16" [2106]	70 3/8" [1787]	CTTD1 0770	CTTD1 0870	CTTD1 0970	CTTD1 0970	CTTD1 1070	CTTD1 1170	
	95 3/8" [2422]	95 1/16" [2415]	94 1/2" [2400]	91 7/16" [2322]	78 7/8" [2003]	CTTD1 0724	CTTD1 0824	CTTD1 0924	CTTD1 0924	CTTD1 1024	CTTD1 1124	
	98 1/4" [2496]	98" [2489]	97 3/8" [2474]	94 5/16" [2396]	81 3/4" [2077]	CTTD1 0780	CTTD1 0880	CTTD1 0980	CTTD1 0980	CTTD1 1080	CTTD1 1180	
	99 15/16" [2538]	99 5/8" [2531]	99 1/16" [2516]	96" [2438]	83 7/16" [2119]	CTTD1 0725	CTTD1 0825	CTTD1 0925	CTTD1 0925	CTTD1 1025	CTTD1 1125	
	107 3/16 [2722]	106 7/8" [2715]	106 5/16" [2700]	103 1/4" [2622]	90 11/16" [2303]	CTTD1 0727	CTTD1 0827	CTTD1 0927	CTTD1 0927	CTTD1 1027	CTTD1 1127	
	124 5/16 [3157]	124" [3150]	123 7/16" [3135]	120 3/8" [3057]	107 13/16" [2738]	CTTD1 0732	CTTD1 0832	CTTD1 0932				

Swinging Terrace & French Doors -
1.75 Inch - **Standard Stile (>3") TD**

Size Charts

Cambertop TD2

Width

Rough Opening Inswing with Jamb Extension					Width							
					46 3/4" [1187]	60 7/16" [1535]	66 15/16" [1701]	72 1/4" [1835]	75 3/8" [1915]	80 1/8" [2035]	87 5/16" [2217]	
Rough Opening		Frame			Width							
		46 1/8" [1171]	59 13/16" [1519]	66 5/16" [1685]	70 5/8" [1819]	74 3/4" [1899]	79 1/2" [2019]	86 5/8" [2201]				
Frame			Panel		Width							
			45 3/8" [1152]	59 1/16" [1500]	65 9/16" [1666]	70 7/8" [1800]	70 7/8" [1880]	78 3/4" [2000]	85 7/8" [2182]			
Panel				Visible Glass	Width							
				21 3/4" [552]	28 9/16" [726]	31 7/8" [809]	34 1/2" [876]	36 1/16" [916]	38 7/16" [976]	42" [1067]		
Visible Glass					Width							
					13 1/16" [332]	19 15/16" [506]	23 3/16" [589]	25 13/16" [656]	27 3/8" [696]	29 3/4" [756]	33 3/8" [847]	
80 3/8" [2042]	80 1/8" [2035]	79 1/2" [2020]	76 7/16" [1942]	63 3/4" [1619]	CTTD2 1220	CTTD2 1520	CTTD2 1620	CTTD2 1820	CTTD2 1820	CTTD2 2020	CTTD2 2220	
82 3/16" [2087]	81 7/8" [2080]	81 5/16" [2065]	78 1/4" [1987]	65 1/2" [1664]	CTTD2 1221	CTTD2 1521	CTTD2 1621	CTTD2 1821	CTTD2 1821	CTTD2 2021	CTTD2 2221	
86 7/8" [2206]	86 9/16" [2199]	86" [2184]	82 15/16" [2106]	70 3/16" [1783]	CTTD2 1270	CTTD2 1570	CTTD2 1670	CTTD2 1870	CTTD2 1870	CTTD2 2070	CTTD2 2270	
95 3/8" [2422]	95 1/16" [2415]	94 1/2" [2400]	91 7/16" [2322]	78 3/4" [1999]	CTTD2 1224	CTTD2 1524	CTTD2 1624	CTTD2 1824	CTTD2 1824	CTTD2 2024	CTTD2 2224	
98 1/4" [2496]	98" [2489]	97 3/8" [2474]	94 5/16" [2396]	81 3/4" [2077]	CTTD2 1280	CTTD2 1580	CTTD2 1680	CTTD2 1880				
99 15/16" [2538]	99 5/8" [2531]	99 1/16" [2516]	96" [2438]	83 5/16" [2115]	CTTD2 1225	CTTD2 1525	CTTD2 1625	CTTD2 1825				
107 3/16 [2722]	106 7/8" [2715]	106 5/16" [2700]	103 1/4" [2622]	90 1/2" [2299]	CTTD2 1227	CTTD2 1527	CTTD2 1627	CTTD2 1827				
124 5/16 [3157]	124" [3150]	123 7/16" [3135]	120 3/8" [3057]	107 13/16" [2738]	CTTD2 1232	CTTD2 1532	CTTD2 1632	CTTD2 1832				

Height

Swinging Terrace & French Doors -
1.75 Inch - **Standard Stile (>3") TD**

Size Charts

Quarter Round TD1

Width

					Rough Opening Inswing with Jamb Extension							
					31 7/8" [809] 35 1/82" [892] 37 3/4" [959] 39 5/16" [999]							
					Rough Opening				31 1/4" [793] 34 1/2" [876] 37 1/8" [943] 38 11/16" [983]			
					Frame				30 1/2" [774] 33 3/4" [857] 36 3/8" [924] 37 15/16" [964]			
					Panel				28 9/16" [726] 31 7/8" [809] 34 1/2" [876] 36 1/16" [916]			
Height					Visible Glass							
					19 15/16" [506] 23 3/16" [589] 25 13/16" [656] 27 3/8" [696]							
					80 3/8" [2042]		80 1/8" [2035]		79 1/2" [2020]		76 7/16" [1942]	
					82 3/16" [2087]		81 7/8" [2080]		81 5/16" [2065]		78 1/4" [1987]	
					86 7/8" [2206]		86 9/16" [2199]		86" [2184]		82 15/16" [2106]	
		95 3/8" [2422]		95 1/16" [2415]		94 1/2" [2400]		91 7/16" [2322]				
		98 1/4" [2496]		98" [2489]		97 3/8" [2474]		94 5/16" [2396]				
		99 15/16" [2538]		99 5/8" [2531]		99 1/16" [2516]		96" [2438]				
107 3/16" [2722]		106 7/8" [2715]		106 5/16" [2700]		103 1/4" [2622]						
124 5/16" [3157]		124" [3150]		123 7/16" [3135]		120 3/8" [3057]						
								63 3/8" [1610]				
								65 3/16" [1655]				
								69 7/8" [1774]				
								78 3/8" [1990]				
								81 3/4" [2077]				
								82 15/16" [2106]				
								90 3/16" [2290]				
								107 13/16" [2738]				
								CTTD1 0720				
								CTTD1 0721				
								CTTD1 0770				
								CTTD1 0724				
								CTTD1 0780				
								CTTD1 0725				
								CTTD1 0727				
								CTTD1 0732				
								CTTD1 0820				
								CTTD1 0821				
								CTTD1 0870				
								CTTD1 0824				
								CTTD1 0880				
								CTTD1 0825				
								CTTD1 0827				
								CTTD1 0832				
								CTTD1 0921				
								CTTD1 0921				
								CTTD1 0970				
								CTTD1 0970				
								CTTD1 0924				
								CTTD1 0924				
								CTTD1 0925				
								CTTD1 0925				
								CTTD1 0927				
								CTTD1 0927				
								CTTD1 0932				
								CTTD1 0932				

* Availability of half/quarter doors in metal clad may be limited. Consult you Authorized Loewen Dealer

Swinging Terrace & French Doors -
1.75 Inch - **Standard Stile (>3") TD**

Size Charts

Quarter Round TD2

					Width				
Height	Rough Opening Inswing with Jamb Extension					60 7/16" [1535]	66 15/16" [1701]	72 1/4" [1835]	39 5/16" [999]
	Rough Opening					59 13/16" [1519]	66 5/16" [1685]	70 5/8" [1819]	38 11/16" [983]
	Frame					59 1/16" [1500]	65 9/16" [1666]	70 7/8" [1800]	37 15/16" [964]
	Panel					28 9/16" [726]	31 7/8" [809]	34 1/2" [87]6	36 1/16" [916]
	Visible Glass					19 15/16" [506]	23 3/16" [589]	25 13/16" [656]	27 3/8" [696]
80 3/8" [2042]	80 1/8" [2035]	79 1/2" [2020]	76 7/16" [1942]	63 3/8" [1610]	CTTD2 1520	CTTD2 1620			
82 3/16" [2087]	81 7/8" [2080]	81 5/16" [2065]	78 1/4" [1987]	65 3/16" [1655]	CTTD2 1521	CTTD2 1621	CTTD2 1821	CTTD2 1821	
86 7/8" [2206]	86 9/16" [2199]	86" [2184]	82 15/16" [2106]	69 7/8" [1774]	CTTD2 1570	CTTD2 1670	CTTD2 1870	CTTD2 1870	
95 3/8" [2422]	95 1/16" [2415]	94 1/2" [2400]	91 7/16" [2322]	78 3/8" [1990]	CTTD2 1524	CTTD2 1624	CTTD2 1824	CTTD2 1824	
98 1/4" [2496]	98" [2489]	97 3/8" [2474]	94 5/16" [2396]	81 3/4" [2077]	CTTD2 1580	CTTD2 1680	CTTD2 1880	CTTD2 1880	
99 15/16" [2538]	99 5/8" [2531]	99 1/16" [2516]	96" [2438]	82 15/16" [2106]	CTTD2 1525	CTTD2 1625	CTTD2 1825	CTTD2 1825	
107 3/16 [2722]	106 7/8" [2715]	106 5/16" [2700]	103 1/4" [2622]	90 3/16" [2290]	CTTD2 1527	CTTD2 1627	CTTD2 1827	CTTD2 1827	
124 5/16 [3157]	124" [3150]	123 7/16" [3135]	120 3/8" [3057]	107 13/16" [2738]	CTTD2 1532	CTTD2 1632	CTTD2 1832	CTTD2 1832	

* Availability of half/quarter doors in metal clad may be limited. Consult you Authorized Loewen Dealer

Swinging Terrace & French Doors -
1.75 Inch - **Standard Stile (>3") TD**

Size Charts

Half Round TD1 Non-Clad

					Width				
Height	Rough Opening Inswing with Jamb Extension					31 7/8" [809]	35 1/82" [892]	37 3/4" [959]	39 5/16" [999]
	Rough Opening					31 1/4" [793]	34 1/2" [876]	37 1/8" [943]	38 11/16" [983]
	Frame					30 1/2" [774]	33 3/4" [857]	36 3/8" [924]	37 15/16" [964]
			Panel			28 9/16" [726]	31 7/8" [809]	34 1/2" [876]	36 1/16" [916]
					Visible Glass	19 15/16" [506]	23 3/16" [589]	25 13/16" [656]	27 3/8" [696]
82 3/16" [2087]	81 7/8" [2080]	81 5/16" [2065]	78 1/4" [1987]	65 11/16" [1668]	CTTD1 0721	CTTD1 0821	CTTD1 0921	CTTD1 0921	
86 7/8" [2206]	86 9/16" [2199]	86" [2184]	82 15/16" [2106]	70 3/8" [1787]	CTTD1 0770	CTTD1 0870	CTTD1 0970	CTTD1 0970	
95 3/8" [2422]	95 1/16" [2415]	94 1/2" [2400]	91 7/16" [2322]	78 7/8" [2003]	CTTD1 0724	CTTD1 0824	CTTD1 0924	CTTD1 0924	
98 1/4" [2496]	98" [2489]	97 3/8" [2474]	94 5/16" [2396]	81 3/4" [2077]	CTTD1 0780	CTTD1 0880	CTTD1 0980	CTTD1 0980	
99 15/16" [2538]	99 5/8" [2531]	99 1/16" [2516]	96" [2438]	83 7/16" [2119]	CTTD1 0725	CTTD1 0825	CTTD1 0925	CTTD1 0925	
107 3/16 [2722]	106 7/8" [2715]	106 5/16" [2700]	103 1/4" [2622]	90 11/16" [2303]	CTTD1 0727	CTTD1 0827	CTTD1 0927	CTTD1 0927	
124 5/16 [3157]	124" [3150]	123 7/16" [3135]	120 3/8" [3057]	107 13/16" [2738]	CTTD1 0732	CTTD1 0832	CTTD1 0932	CTTD1 0932	

* Availability of half/quarter doors in metal clad may be limited. Consult you Authorized Loewen Dealer

Swinging Terrace & French Doors -
1.75 Inch - **Standard Stile (>3") TD**

Drawings

Inswing

HEAD & SILL DETAIL

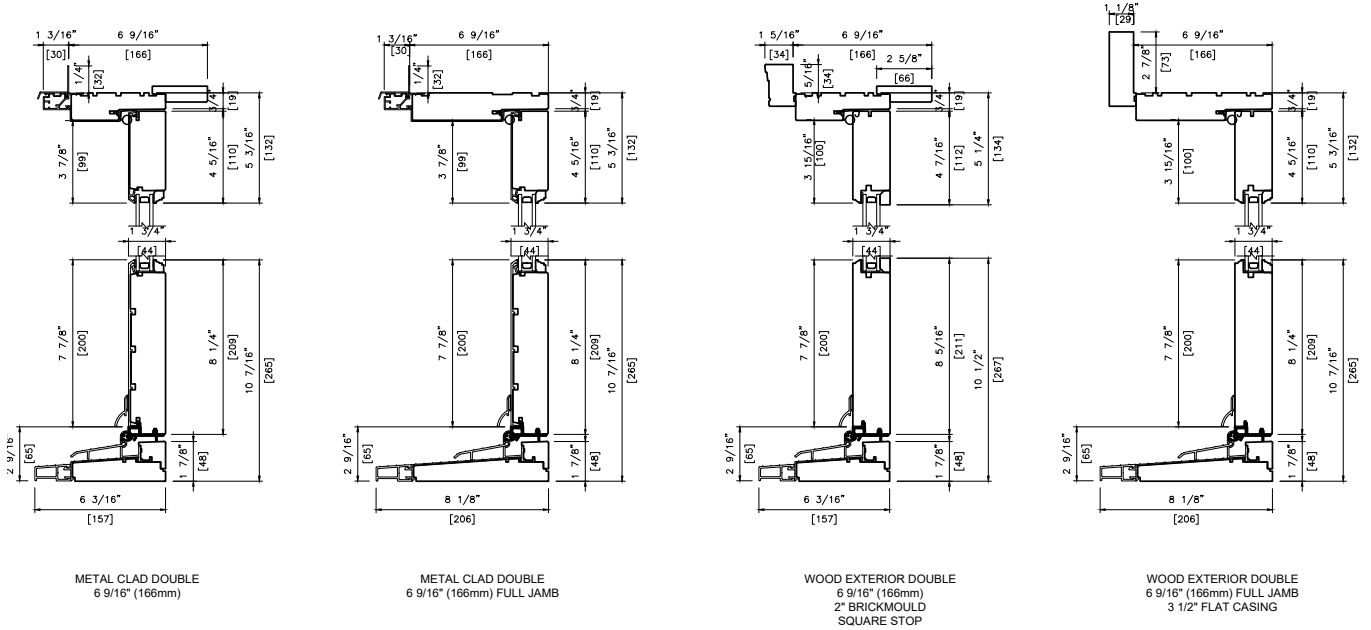

HEAD & SILL DETAIL

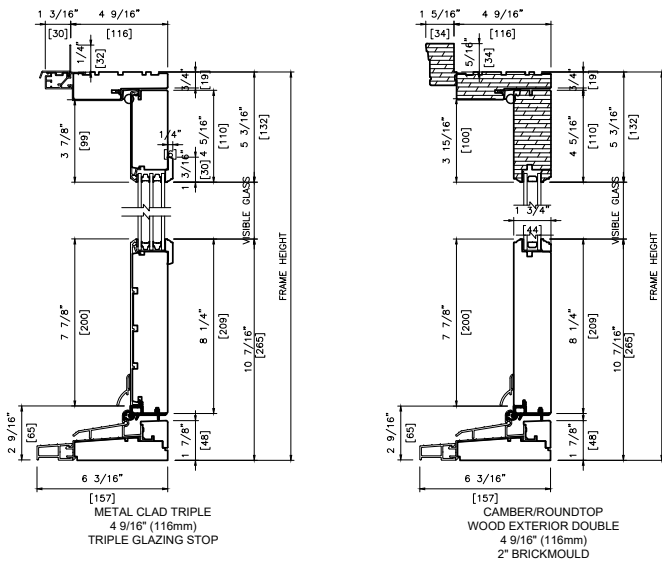

 RADIUS COMPONENT

GLAZING STOP PROFILES

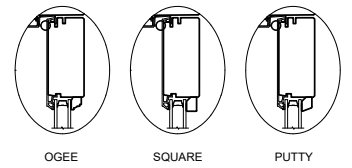

Casing

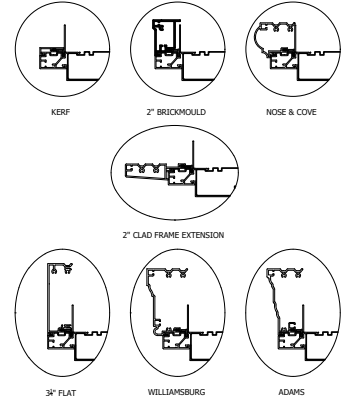

Swinging Terrace & French Doors -
1.75 Inch - **Standard Stile (>3") TD**

Drawings

Inswing (cont'd)

PLAN VIEW

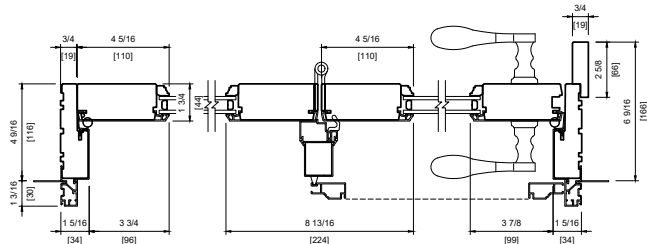

METAL CLAD DOUBLE TWO PANEL

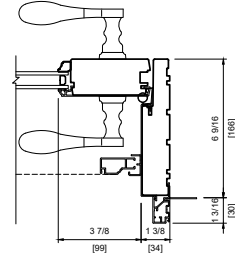

METAL CLAD DOUBLE 6 9/16" (166 mm) FULL JAMB

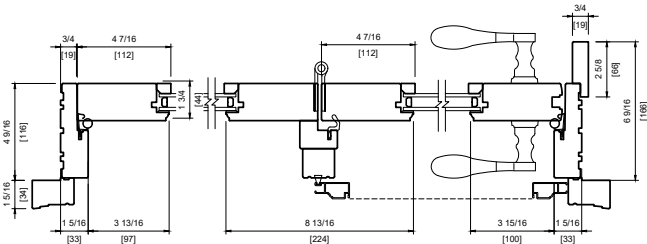

WOOD EXTERIOR DOUBLE TWO PANEL 2" BRICKMOULD SQUARE STOP

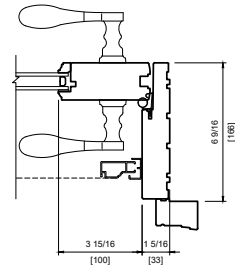

WOOD EXTERIOR DOUBLE 6 9/16" (166 mm) FULL JAMB 2" BRICKMOULD

PLAN VIEW

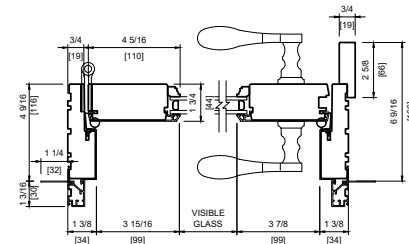

METAL CLAD DOUBLE ONE PANEL

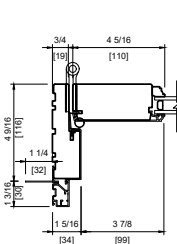

METAL CLAD DOUBLE CAMBERTOP

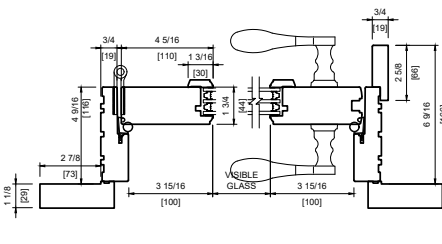

WOOD EXTERIOR TRIPLE ONE PANEL 3 1/2" FLAT CASING TRIPLE GLAZING STOP

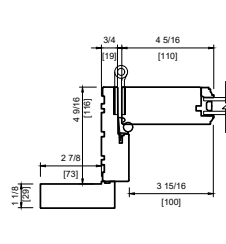

WOOD EXTERIOR DOUBLE TRIPLE CAMBERTOP 3 1/2" FLAT CASING

GLAZING STOP PROFILES

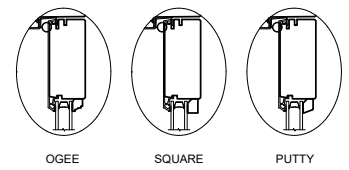

Casing

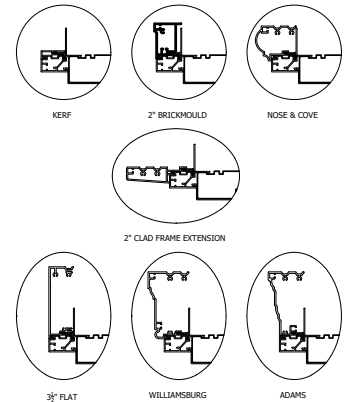

Swinging Terrace & French Doors -
1.75 Inch - **Standard Stile (>3") TD**

Drawings

3 & 4 Wide Inswing

PLAN VIEW

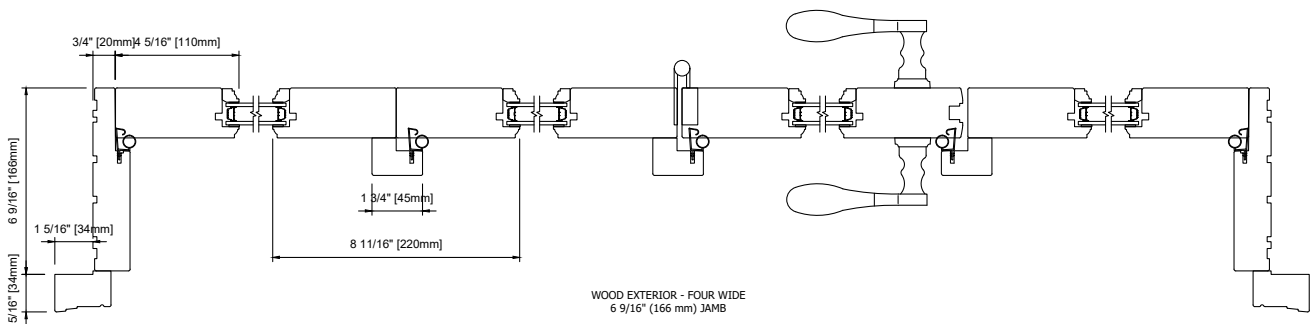
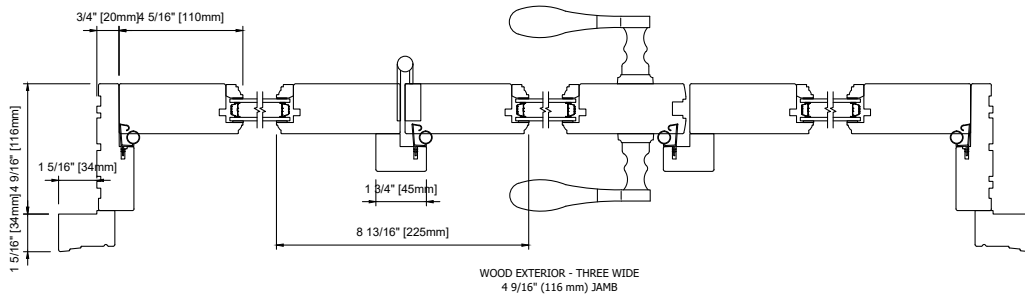
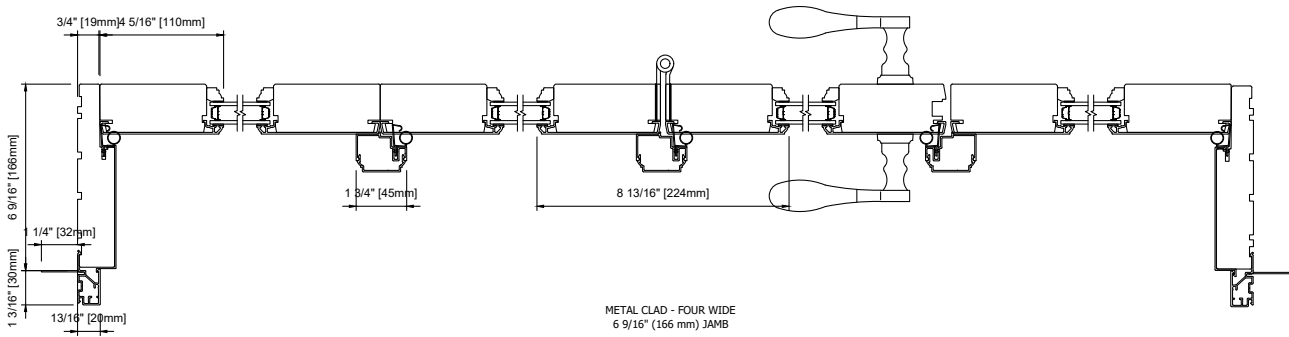
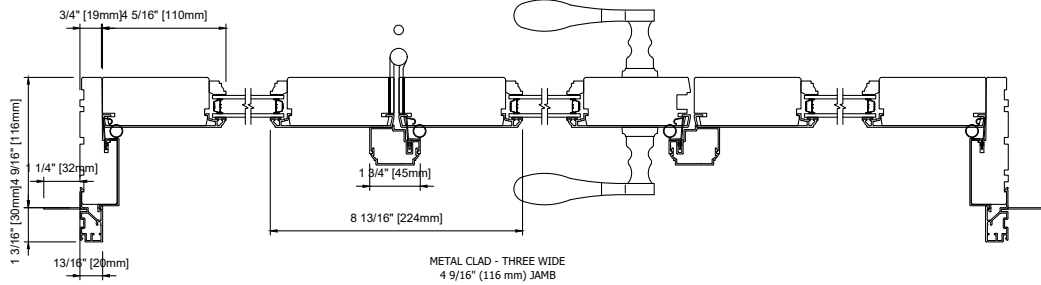

Swinging Terrace & French Doors -
1.75 Inch - **Standard Stile (>3")** TD

Drawings

Outswing

HEAD & SILL DETAILS

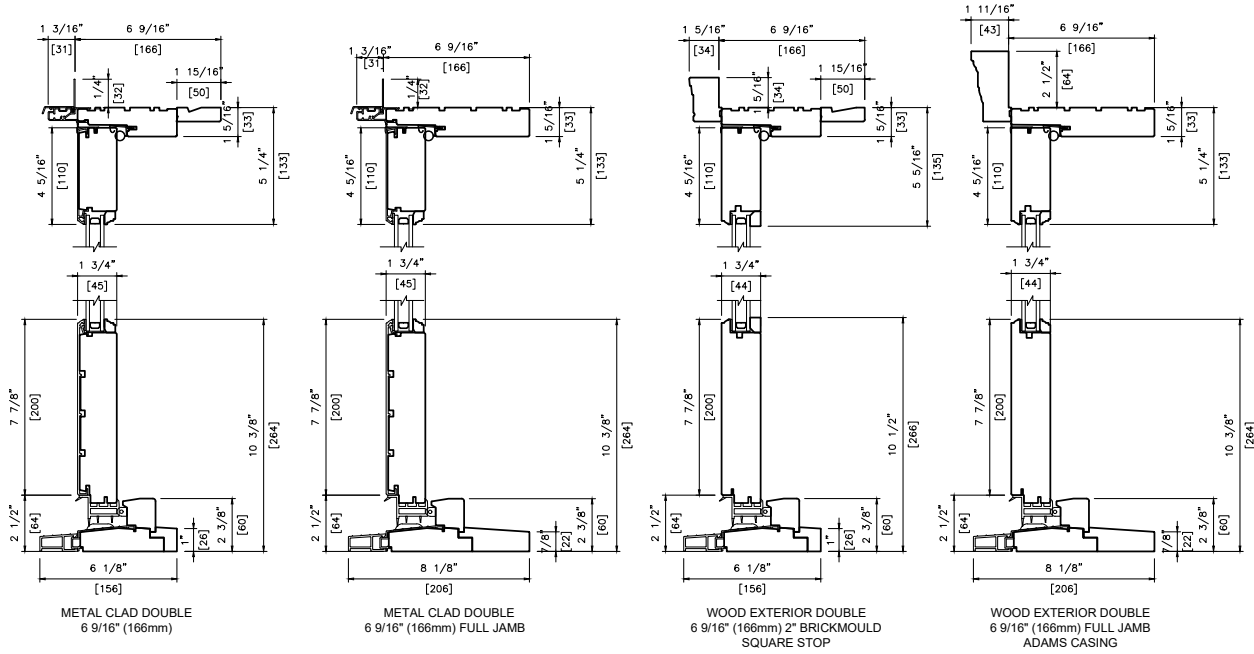

HEAD & SILL DETAILS

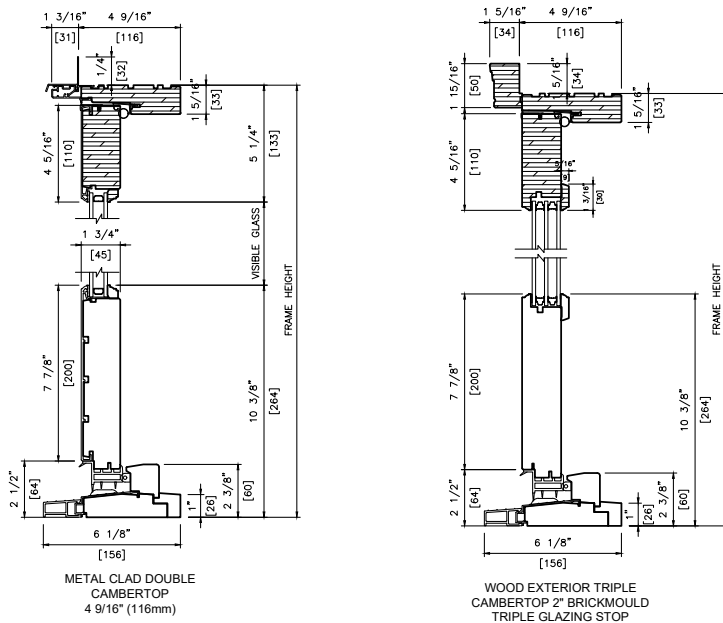

GLAZING STOP PROFILES

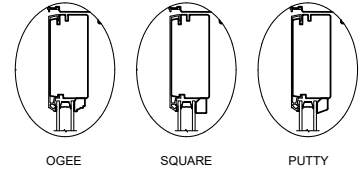

Casing

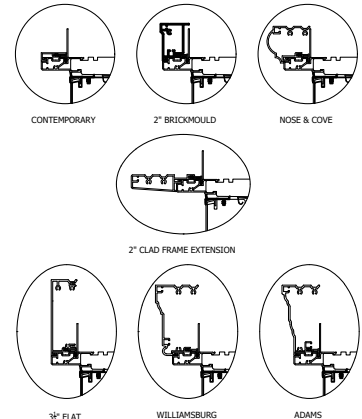

SEE PAGE A22 FOR DIMENSIONS.



Swinging Terrace & French Doors -
1.75 Inch - Standard Stile (>3") TD

Drawings

Outswing (cont'd)

PLAN VIEW

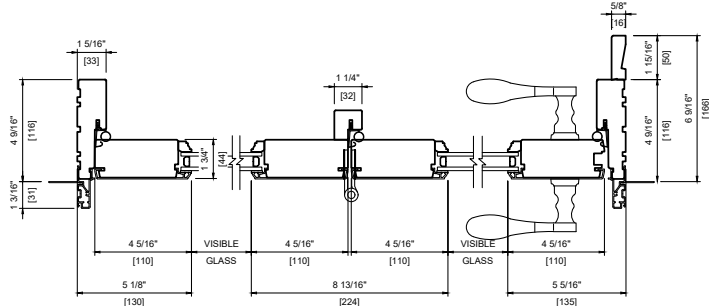

METAL CLAD DOUBLE
TWO PANEL

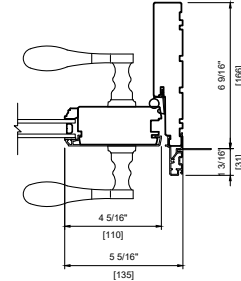

METAL CLAD DOUBLE
6 9/16" (166 mm) FULL
JAMB

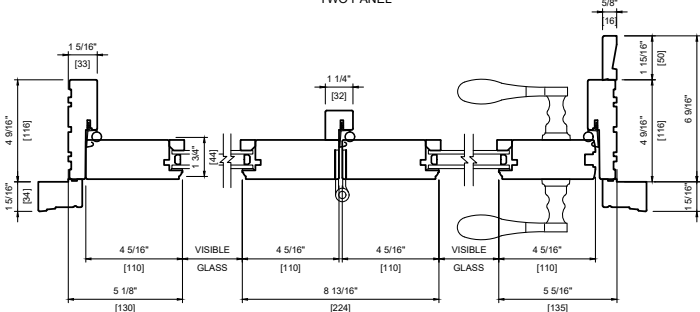

WOOD EXTERIOR DOUBLE
TWO PANEL 2 BRICKMOULD
SQUARE STOP

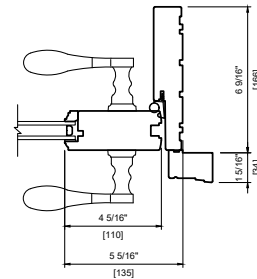

WOOD EXTERIOR DOUBLE
6 9/16" (166 mm) FULL JAMB
2" BRICKMOULD

PLAN VIEW

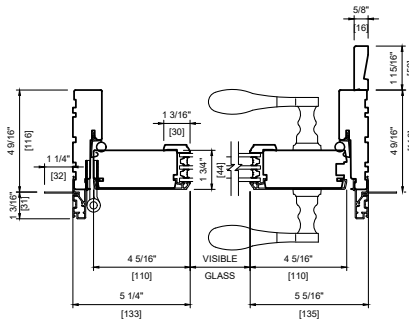

METAL CLAD TRIPLE
ONE PANEL
TRIPLE GLAZING STOP

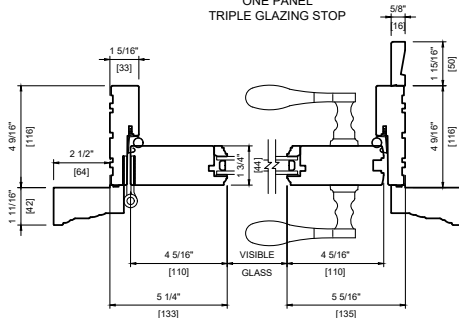

WOOD EXTERIOR DOUBLE
ONE PANEL
ADAMS CASING

GLAZING STOP PROFILES

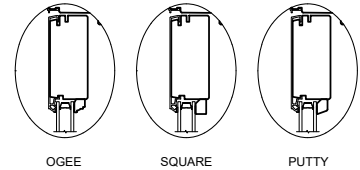

Casing

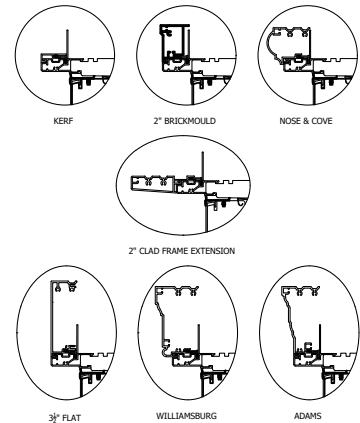

Swinging Terrace & French Doors -
1.75 Inch - **Standard Stile (>3") TD**

Drawings

3 & 4 Wide Outswing

PLAN VIEW

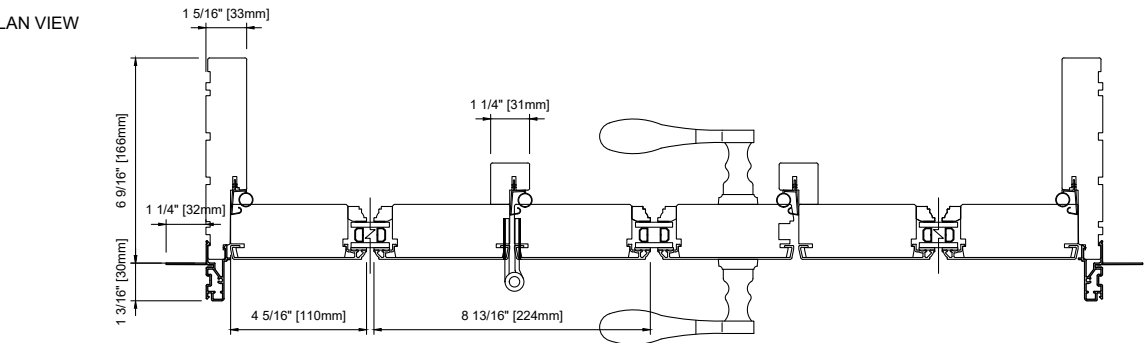

METAL CLAD - THREE WIDE
4 9/16" (116 mm) JAMB

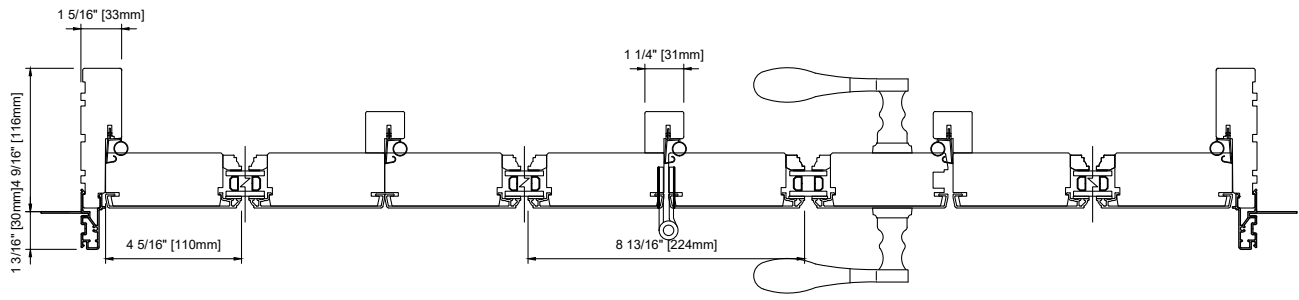

METAL CLAD - FOUR WIDE
6 9/16" (166 mm) JAMB

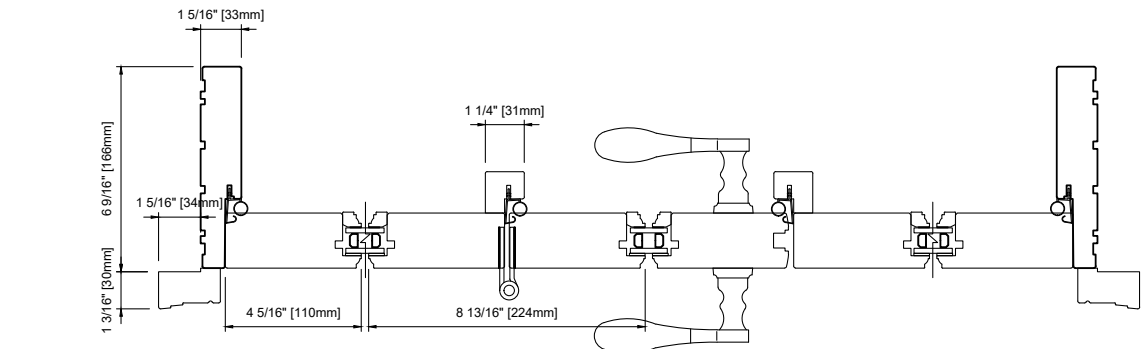

WOOD EXTERIOR - THREE WIDE
6 9/16" (166 mm) JAMB

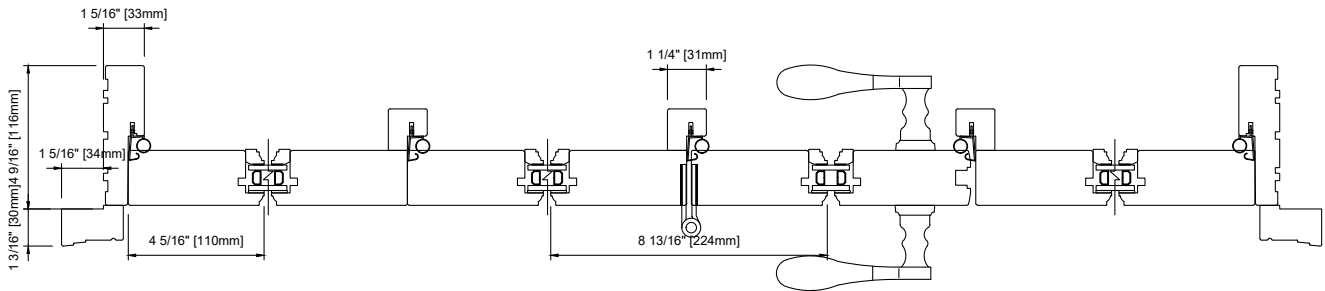

WOOD EXTERIOR - FOUR WIDE
4 9/16" (116 mm) JAMB

Swinging Terrace & French Doors -
1.75 Inch - **Standard Stile (>3") TD**

Drawings

Transom Rail

HEAD & SILL DETAIL

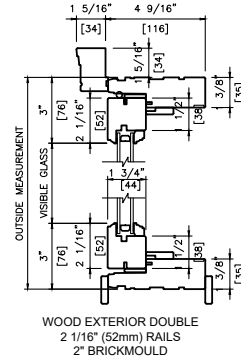
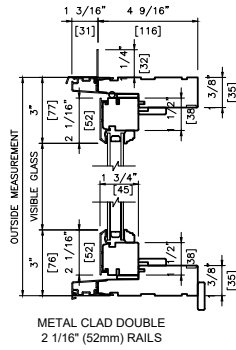

PLAN VIEW

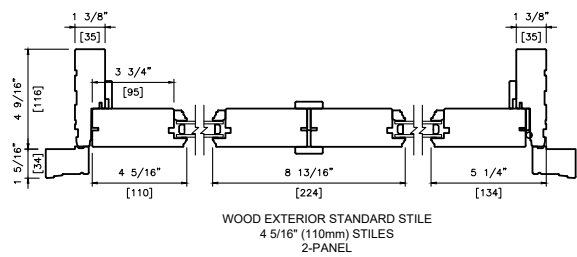
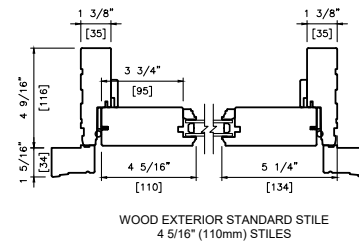
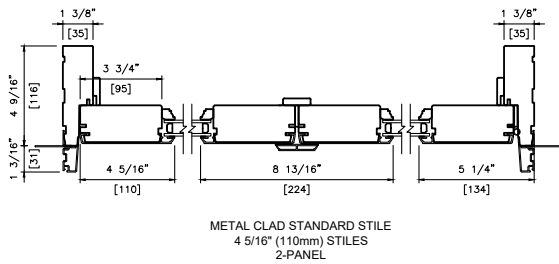
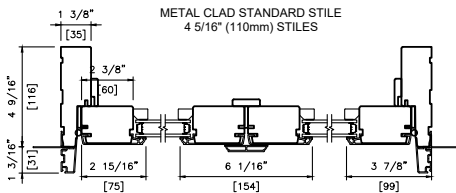
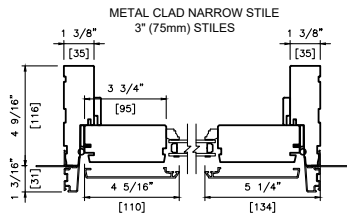
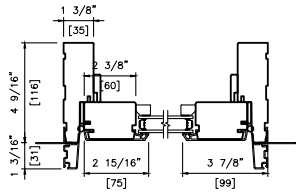

Swinging Terrace & French Doors -
1.75 Inch - **Narrow Stile (3") FD**

Size Charts

FD2

Width

Rough Opening Inswing with Jamb Extension					47 7/8" [1216]	61 9/16" [1564]	68 1/8" [1730]	73 3/8" [1864]	76 9/16" [1944]	81 1/4" [2064]	88 7/16" [2246]					
					Rough Opening					47 1/4" [1200]	60 15/16" [1548]	67 1/2" [1714]	72 3/4" [1848]	75 7/8" [1928]	80 5/8" [2048]	87 13/16" [2230]
					Frame					46 1/2" [1181]	60 3/16" [1529]	66 3/4" [1695]	72" [1829]	75 3/16" [1909]	79 7/8" [2029]	87 1/16" [2211]
					Panel					21 3/4" [552]	28 9/16" [726]	31 7/8" [809]	34 1/2" [876]	36 1/6" [916]	38 7/16" [976]	42" [1067]
					Visible Glass					15 13/16" [402]	22 11/16" [576]	25 15/16" [659]	28 9/16" [726]	27 3/8" [696]	32 1/2" [826]	33 3/8" [847]
					TRANSOM											
16 5/8" [422]	16 5/16" [415]	15 3/4" [400]	13 7/8" [352]	9 11/16" [246]	*FDT2 1204	*FDT2 1504	*FDT2 1604	*FDT2 1804	*FDT2 1804	*FDT2 2004	*FDT2 2204					
24 1/2" [622]	24 3/16" [615]	23 5/8" [600]	21 3/4" [552]	17 9/16" [446]	*FDT2 1206	*FDT2 1506	*FDT2 1606	*FDT2 1806	*FDT2 1806	*FDT2 2006	*FDT2 2206					
					DOOR											
80 3/8" [2042]	80 1/8" [2035]	79 1/2" [2020]	76 7/16" [1942]	68 13/16" [1748]	FD2 1220	FD2 1520	FD2 1620	FD2 1820	FD2 1820	FD2 2020	FD2 2220					
82 3/16" [2087]	81 7/8" [2080]	81 5/16" [2065]	78 1/4" [1987]	70 9/16" [1793]	FD2 1221	FD2 1521	FD2 1621	FD2 1821	FD2 1821	FD2 2021	FD2 2221					
86 7/8" [2206]	86 9/16" [2199]	86" [2184]	82 15/16" [2106]	75 1/4" [1912]	FD2 1270	FD2 1570	FD2 1670	FD2 1870	FD2 1870	FD2 2070	FD2 2270					
95 3/8" [2422]	95 1/16" [2415]	94 1/2" [2400]	91 7/16" [2322]	83 3/4" [2128]	FD2 1224	FD2 1524	FD2 1624	FD2 1824	FD2 1824	FD2 2024	FD2 2224					
98 1/4" [2496]	98" [2489]	97 3/8" [2474]	94 5/16" [2396]	86 11/16" [2202]	FD2 1280	FD2 1580	FD2 1680	FD2 1880	FD2 1880	FD2 2080	FD2 2280					
99 15/16" [2538]	99 5/8" [2531]	99 1/16" [2516]	96" [2438]	88 3/8" [2244]	FD2 1225	FD2 1525	FD2 1625	FD2 1825	FD2 1825	FD2 2025	FD2 2225					
107 3/16 [2722]	106 7/8" [2715]	106 5/16" [2700]	103 1/4" [2622]	95 9/16" [2428]	FD2 1227	FD2 1527	FD2 1627	FD2 1827	FD2 1827	FD2 2027	FD2 2227					

Height

* Transom units

Swinging Terrace & French Doors -
1.75 Inch - **Narrow Stile (3") FD**

Size Charts

FD3

					Width						
Rough Opening Inswing with Jamb Extension						90 3/16" [2290]	100" [2539]	107 7/8" [2740]			
					Rough Opening				89 1/2" [2274]	99 5/16" [2523]	107 1/4" [2724]
					Frame				88 3/4" [2255]	98 9/16" [2504]	106 1/2" [2705]
					Panel				28 9/16" [726]	31 7/8" [809]	34 1/2" [876]
					Visible Glass				22 11/16" [576]	25 15/16" [659]	28 9/16" [726]
					TRANSOM						
16 5/8" [422]	16 5/16" [415]	15 3/4" [400]	13 7/8" [352]	9 11/16" [246]	*FDT3 2204	*FDT3 2404	*FDT3 2704				
24 1/2" [622]	24 3/16" [615]	23 5/8" [600]	21 3/4" [552]	17 9/16" [446]	*FDT3 2206	*FDT3 2406	*FDT3 2706				
					DOOR						
80 3/8" [2042]	80 1/8" [2035]	79 1/2" [2020]	76 7/16" [1942]	68 13/16" [1748]	FD3 2220	FD3 2420	FD3 2720				
82 3/16" [2087]	81 7/8" [2080]	81 5/16" [2065]	78 1/4" [1987]	70 9/16" [1793]	FD3 2221	FD3 2421	FD3 2721				
86 7/8" [2206]	86 9/16" [2199]	86" [2184]	82 15/16" [2106]	75 1/4" [1912]	FD3 2270	FD3 2470	FD3 2770				
95 3/8" [2422]	95 1/16" [2415]	94 1/2" [2400]	91 7/16" [2322]	83 3/4" [2128]	FD3 2224	FD3 2424	FD3 2724				
98 1/4" [2496]	98" [2489]	97 3/8" [2474]	94 5/16" [2396]	86 11/16" [2202]	FD3 2280	FD3 2480	FD3 2780				
99 15/16" [2538]	99 5/8" [2531]	99 1/16" [2516]	96" [2438]	88 3/8" [2244]	FD3 2225	FD3 2425	FD3 2725				
107 3/16 [2722]	106 7/8" [2715]	106 5/16" [2700]	103 1/4" [2622]	95 9/16" [2428]	FD3 2227	FD3 2427	FD3 2727				

* Transom units

Swinging Terrace & French Doors -
1.75 Inch - **Narrow Stile (3") FD**

Size Charts

FD4

Width

Height

Rough Opening Inswing with Jamb Extension					118 3/4" [3016]	131 13/16" [3348]	142 3/8" [3616]	148 11/16" [3776]	158 1/8" [4016]
Rough Opening					118 1/8" [3000]	131 3/16" [3332]	141 3/4" [3600]	148" [3760]	157 1/2" [4000]
Frame					117 3/8" [2981]	130 7/16" [3313]	141" [3581]	147 5/16" [3741]	156 3/4" [3981]
Panel					28 9/16" [726]	31 7/8" [809]	34 1/2" [876]	36 1/6" [916]	38 7/16" [976]
Visible Glass					22 11/16" [576]	25 15/16" [659]	28 9/16" [726]	27 3/8" [696]	32 1/2" [826]
					TRANSOM				
16 5/8" [422]	16 5/16" [415]	15 3/4" [400]	13 7/8" [352]	9 11/16" [246]	*FDT4 3004	*FDT4 3304	*FDT4 3604	*FDT4 3604	*FDT4 4004
24 1/2" [622]	24 3/16" [615]	23 5/8" [600]	21 3/4" [552]	17 9/16" [446]	*FDT4 3006	*FDT4 3306	*FDT4 3606	*FDT4 3606	*FDT4 4006
					DOOR				
80 3/8" [2042]	80 1/8" [2035]	79 1/2" [2020]	76 7/16" [1942]	68 13/16" [1748]	FD4 3020	FD4 3320	FD4 3620	FD4 3620	FD4 4020
82 3/16" [2087]	81 7/8" [2080]	81 5/16" [2065]	78 1/4" [1987]	70 9/16" [1793]	FD4 3021	FD4 3321	FD4 3621	FD4 3621	FD4 4021
86 7/8" [2206]	86 9/16" [2199]	86" [2184]	82 15/16" [2106]	75 1/4" [1912]	FD4 3070	FD4 3370	FD4 3670	FD4 3670	FD4 4070
95 3/8" [2422]	95 1/16" [2415]	94 1/2" [2400]	91 7/16" [2322]	83 3/4" [2128]	FD4 3024	FD4 3324	FD4 3624	FD4 3624	FD4 4024
98 1/4" [2496]	98" [2489]	97 3/8" [2474]	94 5/16" [2396]	86 11/16" [2202]	FD4 3080	FD4 3380	FD4 3680		
99 15/16" [2538]	99 5/8" [2531]	99 1/16" [2516]	96" [2438]	88 3/8" [2244]	FD4 3025	FD4 3325	FD4 3625		
107 3/16 [2722]	106 7/8" [2715]	106 5/16" [2700]	103 1/4" [2622]	95 9/16" [2428]	FD4 30027	FD4 3327	FD4 3627		

* Transom units

Swinging Terrace & French Doors -
1.75 Inch - **Narrow Stile (3")** FD

Drawings

Inswing

HEAD & SILL DETAIL

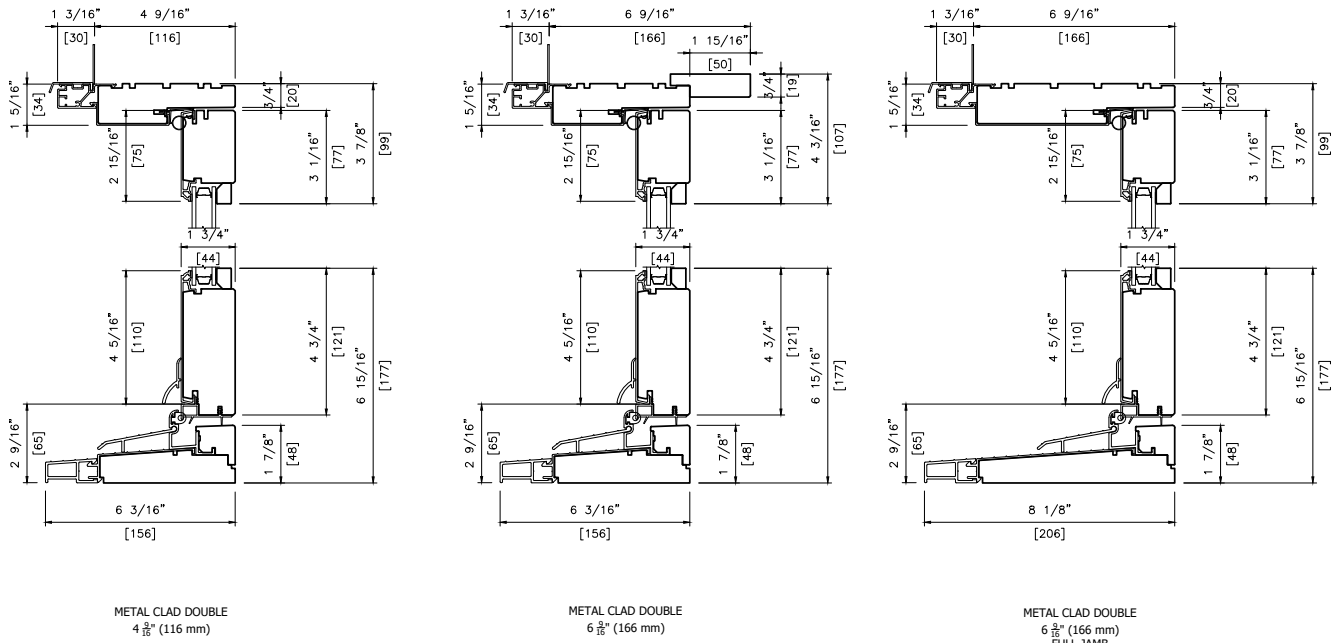

PLAN VIEW

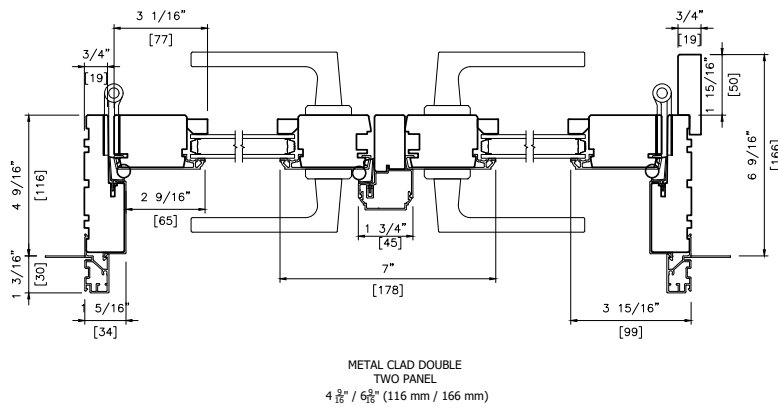

GLAZING STOP PROFILES

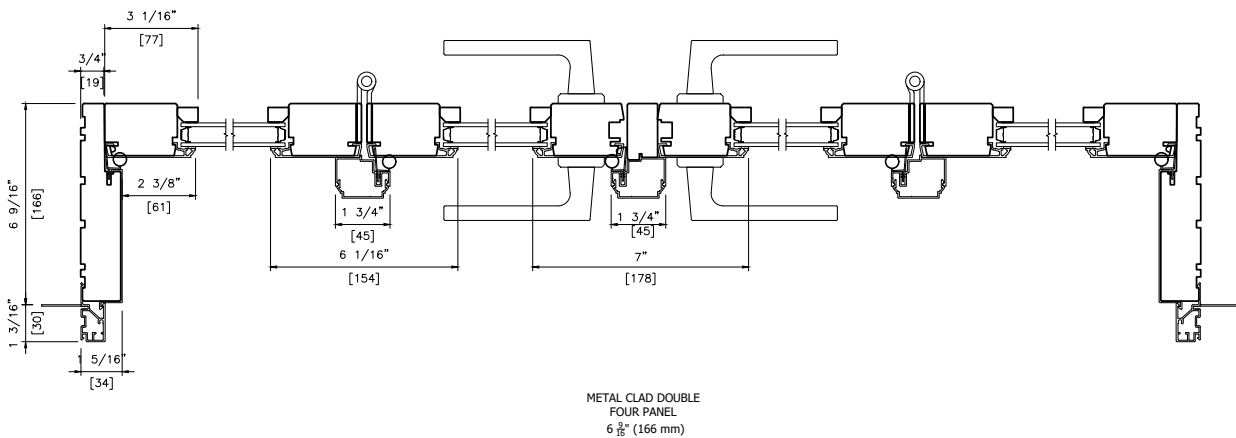
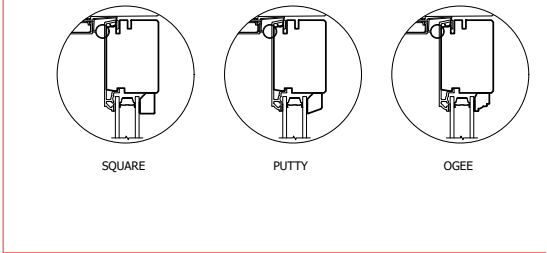

Swinging Terrace & French Doors -
1.75 Inch - **Narrow Stile (3")** FD

Drawings

Outswing

HEAD & SILL DETAIL

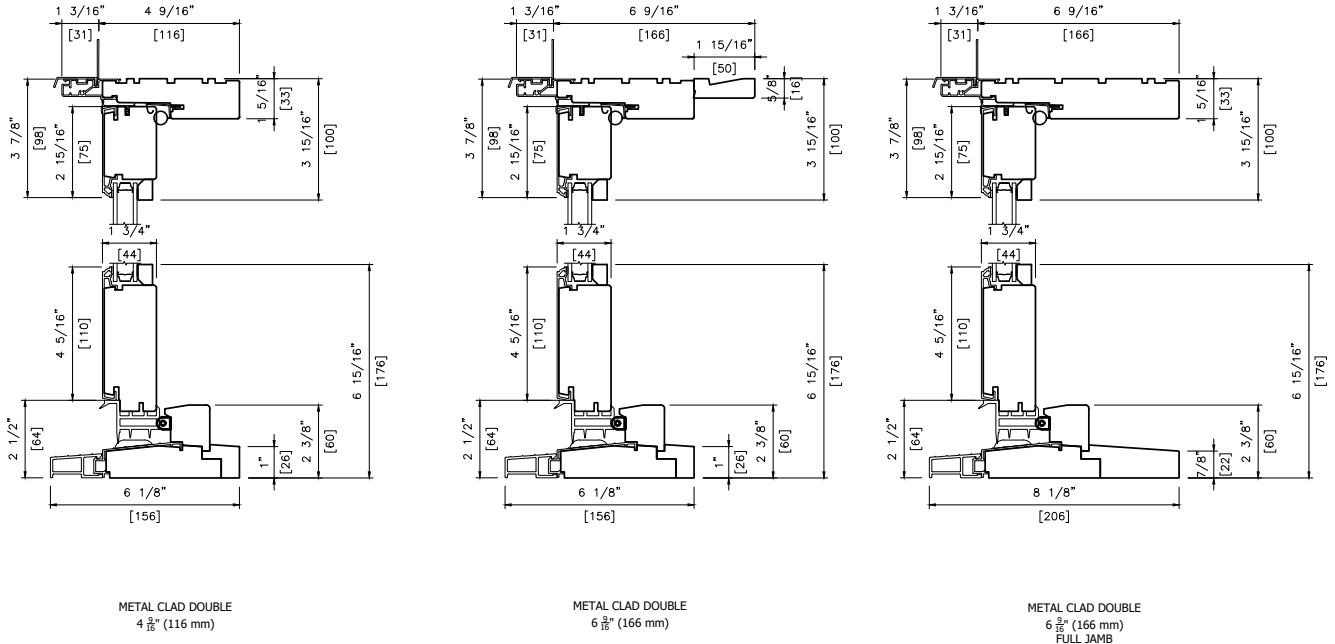

PLAN VIEW

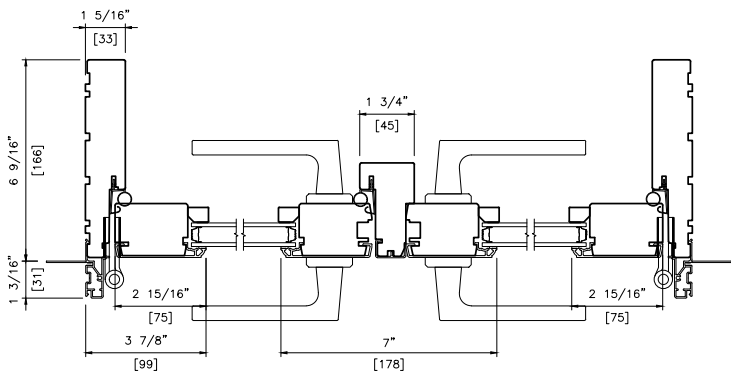

METAL CLAD DOUBLE
TWO PANEL
6 3/8" (166 mm)

GLAZING STOP PROFILES

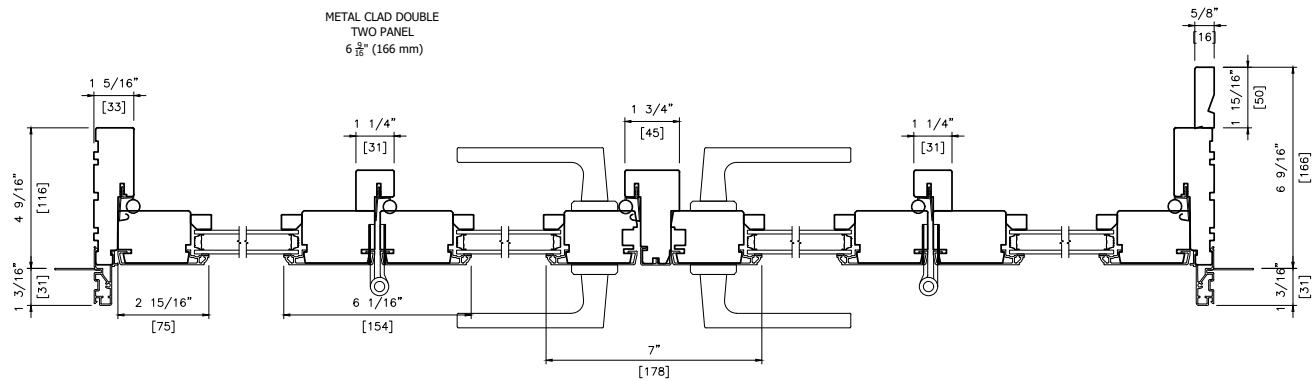
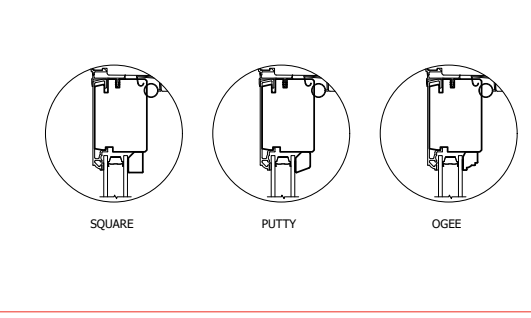

METAL CLAD DOUBLE
FOUR PANEL
4 5/8" / 6 3/8" (116 mm / 166 mm)

Swinging Terrace & French Doors -
1.75 Inch - **Narrow Stile (3")** FD

Drawings

3 Wide Inswing & Outswing

PLAN VIEW
INSWING

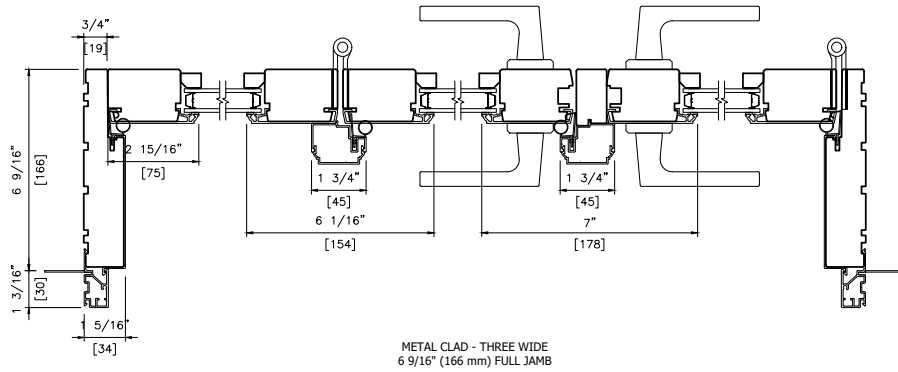

PLAN VIEW
OUTSWING

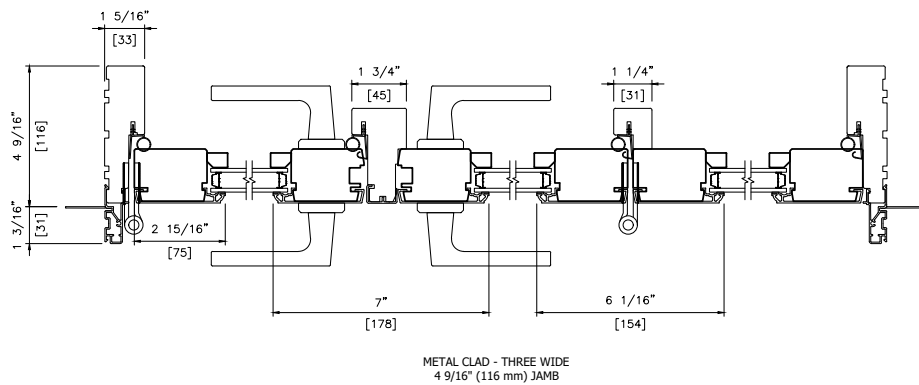

Swinging Terrace & French Doors -
1.75 Inch - **Standard Stile (>3") FD**

Size Charts

FD2

Width

Height

Rough Opening Inswing with Jamb Extension					47 7/8" [1216]	61 9/16" [1564]	68 1/8" [1730]	73 3/8" [1864]	76 9/16" [1944]	81 1/4" [2064]	88 7/16" [2246]
Rough Opening					47 1/4" [1200]	60 15/16" [1548]	67 1/2" [1714]	72 3/4" [1848]	75 7/8" [1928]	80 5/8" [2048]	87 13/16" [2230]
Frame					46 1/2" [1181]	60 3/16" [1529]	66 3/4" [1695]	72" [1829]	75 3/16" [1909]	79 7/8" [2029]	87 1/16" [2211]
Panel					21 3/4" [552]	28 9/16" [726]	31 7/8" [809]	34 1/2" [876]	36 1/6" [916]	38 7/16" [976]	42" [1067]
Visible Glass					13 1/16" [332]	19 15/16" [506]	23 3/16" [589]	25 13/16" [656]	27 3/8" [696]	29 3/4" [756]	33 3/8" [847]
					TRANSOM						
16 5/8" [422]	16 5/16" [415]	15 3/4" [400]	13 7/8" [352]	9 11/16" [246]	*FDT2 1204	*FDT2 1504	*FDT2 1604	*FDT2 1804	*FDT2 1804	*FDT2 2004	*FDT2 2204
24 1/2" [622]	24 3/16" [615]	23 5/8" [600]	21 3/4" [552]	17 9/16" [446]	*FDT2 1206	*FDT2 1506	*FDT2 1606	*FDT2 1806	*FDT2 1806	*FDT2 2006	*FDT2 2206
					DOOR						
80 3/8" [2042]	80 1/8" [2035]	79 1/2" [2020]	76 7/16" [1942]	63 7/8" [1623]	FD2 1220	FD2 1520	FD2 1620	FD2 1820	FD2 1820	FD2 2020	FD2 2220
82 3/16" [2087]	81 7/8" [2080]	81 5/16" [2065]	78 1/4" [1987]	65 11/16" [1668]	FD2 1221	FD2 1521	FD2 1621	FD2 1821	FD2 1821	FD2 2021	FD2 2221
86 7/8" [2206]	86 9/16" [2199]	86" [2184]	82 15/16" [2106]	70 3/8" [1787]	FD2 1270	FD2 1570	FD2 1670	FD2 1870	FD2 1870	FD2 2070	FD2 2270
95 3/8" [2422]	95 1/16" [2415]	94 1/2" [2400]	91 7/16" [2322]	78 7/8" [2003]	FD2 1224	FD2 1524	FD2 1624	FD2 1824	FD2 1824	FD2 2024	FD2 2224
98 1/4" [2496]	98" [2489]	97 3/8" [2474]	94 5/16" [2396]	81 3/4" [2077]	FD2 128	FD2 1580	FD2 1680	FD2 1880	FD2 1880	FD2 2080	FD2 2280
99 15/16" [2538]	99 5/8" [2531]	99 1/16" [2516]	96" [2438]	83 7/16" [2119]	FD2 1225	FD2 1525	FD2 1625	FD2 1825	FD2 1825	FD2 2025	FD2 2225
107 3/16 [2722]	106 7/8" [2715]	106 5/16" [2700]	103 1/4" [2622]	90 11/16" [2303]	FD2 1227	FD2 1527	FD2 1627	FD2 1827	FD2 1827	FD2 2027	FD2 2227
124 5/16 [3157]	124" [3150]	123 7/16" [3135]	120 3/8" [3057]	107 13/16" [2738]	FD2 1232	FD2 1532	FD2 1632	FD2 1832	FD2 1832	FD2 2032	

* Transom units

Swinging Terrace & French Doors -
1.75 Inch - **Standard Stile (>3")** FD

Size Charts

FD3

					Width						
Rough Opening Inswing with Jamb Extension					90 3/16" [2290]	100" [2539]	107 7/8" [2740]				
					Rough Opening		89 1/2" [2274]	99 5/16" [2523]	107 1/4" [2724]		
					Frame			88 3/4" [2255]	98 9/16" [2504]	106 1/2" [2705]	
					Panel				28 9/16" [726]	31 7/8" [809]	34 1/2" [876]
					Visible Glass				19 15/16" [506]	23 3/16" [589]	25 13/16" [656]
					TRANSOM						
16 5/8" [422]	16 5/16" [415]	15 3/4" [400]	13 7/8" [352]	9 11/16" [246]	*FDT3 2204	*FDT3 2404	*FDT3 2704				
24 1/2" [622]	24 3/16" [615]	23 5/8" [600]	21 3/4" [552]	17 9/16" [446]	*FDT3 2206	*FDT3 2406	*FDT3 2706				
					DOORS						
80 3/8" [[2042]]	80 1/8" [[2035]]	79 1/2" [[2020]]	76 7/16" [1942]	63 7/8" [1623]	FD3 2220	FD3 2420	FD3 2720				
82 3/16" [2087]	81 7/8" [2080]	81 5/16" [2065]	78 1/4" [1987]	65 11/16" [1668]	FD3 2221	FD3 2421	FD3 1821				
86 7/8" [2206]	86 9/16" [2199]	86" [2184]	82 15/16" [2106]	70 3/8" [1787]	FD3 2270	FD3 2470	FD3 2770				
95 3/8" [2422]	95 1/16" [2415]	94 1/2" [2400]	91 7/16" [2322]	78 7/8" [2003]	FD3 2224	FD3 2424	FD3 2724				
98 1/4" [2496]	98" [2489]	97 3/8" [2474]	94 5/16" [2396]	81 3/4" [2077]	FD3 2280	FD3 2480	FD3 2780				
99 15/16" [2538]	99 5/8" [2531]	99 1/16" [2516]	96" [2438]	83 7/16" [2119]	FD3 2225	FD3 2425	FD3 2725				
107 3/16" [2722]	106 7/8" [2715]	106 5/16" [2700]	103 1/4" [2622]	90 11/16" [2303]	FD3 2227	FD3 2427	FD3 2727				

Height

* Transom units

Swinging Terrace & French Doors -
1.75 Inch - **Standard Stile (>3") FD**

Size Charts

FD4

Width

Rough Opening Inswing with Jamb Extension					91 5/16"	118 3/4"	131	142 3/8"	148	158 1/8"	172							
					Rough Opening							90	118 1/8"	131	141 3/4"	148"	157 1/2"	171
					Frame							89	117 3/8"	130	141"	147	156 3/4"	171
					Panel							21 3/4"	28 9/16"	31 7/8"	34 1/2"	36 1/6"	38 7/16"	42"
					Visible Glass							13 1/16"	19	23 3/16"	25	27 3/8"	29 3/4"	33 3/8"
					TRANSOM													
16 5/8"	16 5/16"	15 3/4"	13 7/8"	9 11/16"	*FDT4	*FDT4	*FDT4	*FDT4	*FDT4	*FDT4	*FDT4							
[422]	[415]	[400]	[352]	[246]	2304	3004	3304	3604	3604	4004	4304							
24 1/2"	24 3/16"	23 5/8"	21 3/4"	17 9/16"	*FDT4	*FDT4	*FDT4	*FDT4	*FDT4	*FDT4	*FDT4							
[622]	[615]	[600]	[552]	[446]	2306	3006	3306	3606	3606	4006	4306							
					DOOR													
80 3/8"	80 1/8"	79 1/2"	76 7/16"	63 7/8"	FD4	FD4	FD4	FD4	FD4	FD4	FD4							
[2042]	[2035]	[2020]	[1942]	[1623]	2320	3020	3320	3620	3620	4020	4320							
82 3/16"	81 7/8"	81 5/16"	78 1/4"	65	FD4	FD4	FD4	FD4	FD4	FD4	FD4							
[2087]	[2080]	[2065]	[1987]	11/16"	2321	3021	3321	3621	3621	4021	4321							
				[1668]														
86 7/8"	86 9/16"	86"	82	70 3/8"	FD4	FD4	FD4	FD4	FD4	FD4	FD4							
[2206]	[2199]	[2184]	15/16"	[1787]	2370	3070	3370	3670	3670	4070	4370							
			[2106]															
95 3/8"	95 1/16"	94 1/2"	91 7/16"	78 7/8"	FD4	FD4	FD4	FD4	FD4	FD4	FD4							
[2422]	[2415]	[2400]	[2322]	[2003]	2324	3024	3324	3624	3624	4024	4324							
98 1/4"	98"	97 3/8"	94 5/16"	81 3/4"	FD4	FD4	FD4	FD4	FD4	FD4	FD4							
[2496]	[2489]	[2474]	[2396]	[2077]	2380	3080	3380	3680	3680	4080	4380							
99	99 5/8"	99 1/16"	96"	83 7/16"	FD4	FD4	FD4	FD4	FD4	FD4	FD4							
15/16"	[2531]	[2516]	[2438]	[2119]	2325	3025	3325	3625	3625	4025	4325							
[2538]																		
107 3/16"	106 7/8"	106	103 1/4"	90	FD4	FD4	FD4	FD4	FD4	FD4	FD4							
[2722]	[2715]	5/16"	[2622]	11/16"	2327	30027	3327	3627	3627	4027	4327							
		[2700]		[2303]														

Height

* Transom units

Swinging Terrace & French Doors -
1.75 Inch - **Standard Stile (>3")** FD

Size Charts

Cambertop FD2

Width

Rough Opening Inswing with Jamb Extension					Width													
					Rough Opening													
					Frame							Panel						
					Visible Glass						Panel							
					47 7/8" [1216]	61 9/16" [1564]	68 1/8" [1730]	73 3/8" [1864]	76 9/16" [1944]	81 1/4" [2064]	88 7/16" [2246]	47 1/4" [1200]	60 15/16" [1548]	67 1/2" [1714]	72 3/4" [1848]	75 7/8" [1928]	80 5/8" [2048]	87 13/16" [2230]
46 1/2" [1181]					60 3/16" [1529]			66 3/4" [1695]		72" [1829]		75 3/16" [1909]		79 7/8" [2029]		87 1/16" [2211]		
21 3/4" [552]					28 9/16" [726]			31 7/8" [809]		34 1/2" [876]		36 1/6" [916]		38 7/16" [976]		42" [1067]		
13 1/16" [332]					19 15/16" [506]			23 3/16" [589]		25 13/16" [656]		27 3/8" [696]		29 3/4" [756]		33 3/8" [847]		
Height	80 3/8" [2042]	80 1/8" [2035]	79 1/2" [2020]	76 7/16" [1942]	63 7/8" [1623]	FD2 1220	FD2 1520	FD2 1620	FD2 1820	FD2 1820	FD2 2020	FD2 2220						
	82 3/16" [2087]	81 7/8" [2080]	81 5/16" [2065]	78 1/4" [1987]	65 11/16" [1668]	FD2 1221	FD2 1521	FD2 1621	FD2 1821	FD2 1821	FD2 2021	FD2 2221						
	86 7/8" [2206]	86 9/16" [2199]	86" [2184]	82 15/16" [2106]	70 3/8" [1787]	FD2 1270	FD2 1570	FD2 1670	FD2 1870	FD2 1870	FD2 2070	FD2 2270						
	95 3/8" [2422]	95 1/16" [2415]	94 1/2" [2400]	91 7/16" [2322]	78 7/8" [2003]	FD2 1224	FD2 1524	FD2 1624	FD2 1824	FD2 1824	FD2 2024	FD2 2224						
	98 1/4" [2496]	98" [2489]	97 3/8" [2474]	94 5/16" [2396]	81 3/4" [2077]	FD2 1280	FD2 1580	FD2 1680	FD2 1880									
	99 15/16" [2538]	99 5/8" [2531]	99 1/16" [2516]	96" [2438]	83 7/16" [2119]	FD2 1225	FD2 1525	FD2 1625	FD2 1825									
	107 3/16 [2722]	106 7/8" [2715]	106 5/16" [2700]	103 1/4" [2622]	90 11/16" [2303]	FD2 1227	FD2 1527	FD2 1627	FD2 1827									
	124 5/16 [3157]	124" [3150]	123 7/16" [3135]	120 3/8" [3057]	107 13/16" [2738]	FD2 1232	FD2 1532	FD2 1632	FD2 1832									

Swinging Terrace & French Doors -
1.75 Inch - **Standard Stile (>3") FD**

Size Charts

Cambertop FD4

Width

Height

Rough Opening Inswing with Jamb Extension					91 5/16" [2320]	118 3/4" [3016]	131 13/16" [3348]	142 3/8" [3616]	148 11/16" [3776]	158 1/8" [4016]	172 7/16" [4380]
Rough Opening					90 11/16" [2304]	118 1/8" [3000]	131 3/16" [3332]	141 3/4" [3600]	148" [3760]	157 1/2" [4000]	171 13/16" [4364]
Frame					89 15/16" [2285]	117 3/8" [2981]	130 7/16" [3313]	141" [3581]	147 5/16" [3741]	156 3/4" [3981]	171 1/16" [4345]
Panel					21 3/4" [552]	28 9/16" [726]	31 7/8" [809]	34 1/2" [876]	36 1/6" [916]	38 7/16" [976]	42" 1067
Visible Glass					13 1/16" [332]	19 15/16" [506]	23 3/16" [589]	25 13/16" [656]	27 3/8" [696]	29 3/4" [756]	33 3/8" [847]
80 3/8" [2042]	80 1/8" [2035]	79 1/2" [2020]	76 7/16" [1942]	63 3/4" [1619]	FD4 2320	FD4 3020	FD4 3320	FD4 3620	FD4 3620	FD4 4020	FD4 4320
82 3/16" [2087]	81 7/8" [2080]	81 5/16" [2065]	78 1/4" [1987]	65 1/2" [1664]	FD4 2321	FD4 3021	FD4 3321	FD4 3621	FD4 3621	FD4 4021	FD4 4321
86 7/8" [2206]	86 9/16" [2199]	86" [2184]	82 15/16" [2106]	70 3/16" [1783]	FD4 2370	FD4 3070	FD4 3370	FD4 3670	FD4 3670	FD4 4070	FD4 4370
95 3/8" [2422]	95 1/16" [2415]	94 1/2" [2400]	91 7/16" [2322]	78 3/4" [1999]	FD4 2324	FD4 3024	FD4 3324	FD4 3624	FD4 3624	FD4 4024	FD4 4324
98 1/4" [2496]	98" [2489]	97 3/8" [2474]	94 5/16" [2396]	81 3/4" [2077]	FD4 2380	FD4 3080	FD4 3380	FD4 3680			
99 15/16" [2538]	99 5/8" [2531]	99 1/16" [2516]	96" [2438]	83 5/16" [2115]	FD4 2325	FD4 3025	FD4 3325	FD4 3625			
107 3/16 [2722]	106 7/8" [2715]	106 5/16" [2700]	103 1/4" [2622]	90 1/2" [2299]	FD4 2327	FD4 30027	FD4 3327	FD4 3627			

Swinging Terrace & French Doors -
1.75 Inch - **Standard Stile (>3")** FD

Drawings

Inswing

HEAD & SILL DETAIL

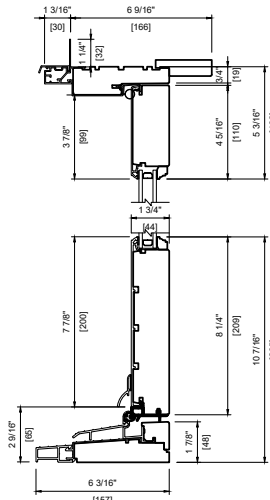

METAL CLAD DOUBLE
6 9/16" (166mm)

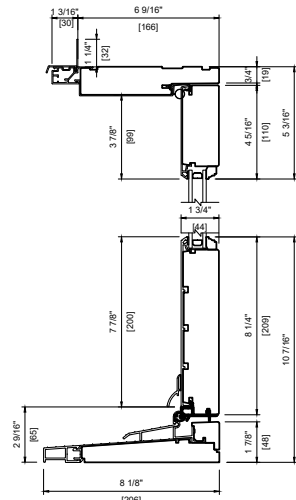

METAL CLAD DOUBLE
6 9/16" (166mm) FULL JAMB

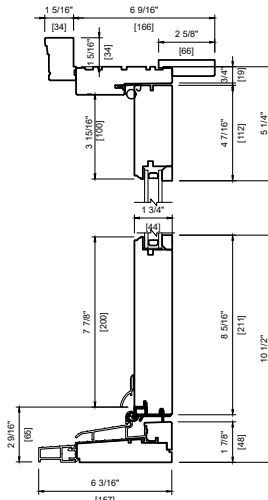

WOOD EXTERIOR DOUBLE
6 9/16" (166mm)
2" BRICKMOULD
SQUARE STOP

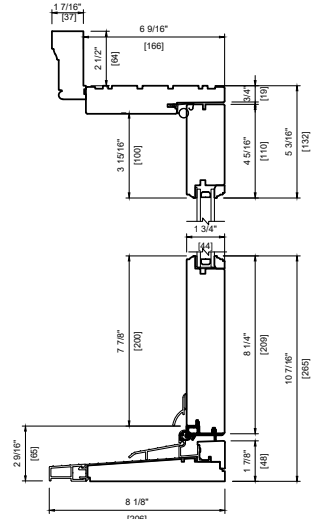

WOOD EXTERIOR DOUBLE
6 9/16" (166mm) FULL JAMB
WILLIAMSBERG CASING

HEAD & SILL DETAIL

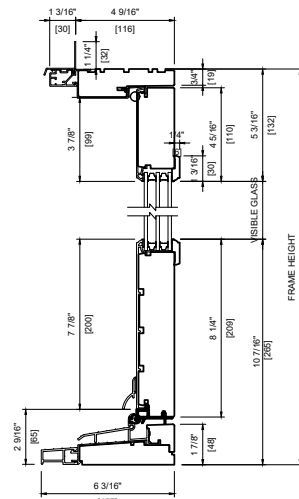

METAL CLAD TRIPLE
4 9/16" (116mm)
TRIPLE GLAZING STOP

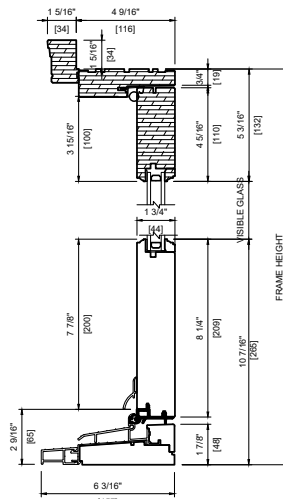

CAMBER/ROUNDTOP
WOOD EXTERIOR DOUBLE
4 9/16" (116mm)
2" BRICKMOULD

GLAZING STOP PROFILES

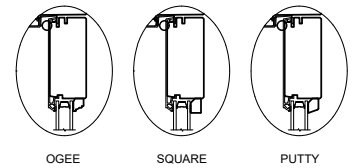

Casing

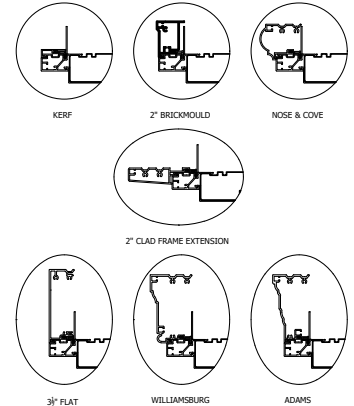

Swinging Terrace & French Doors -
1.75 Inch - **Standard Stile (>3")** FD

Drawings

Inswing (cont'd)

PLAN VIEW

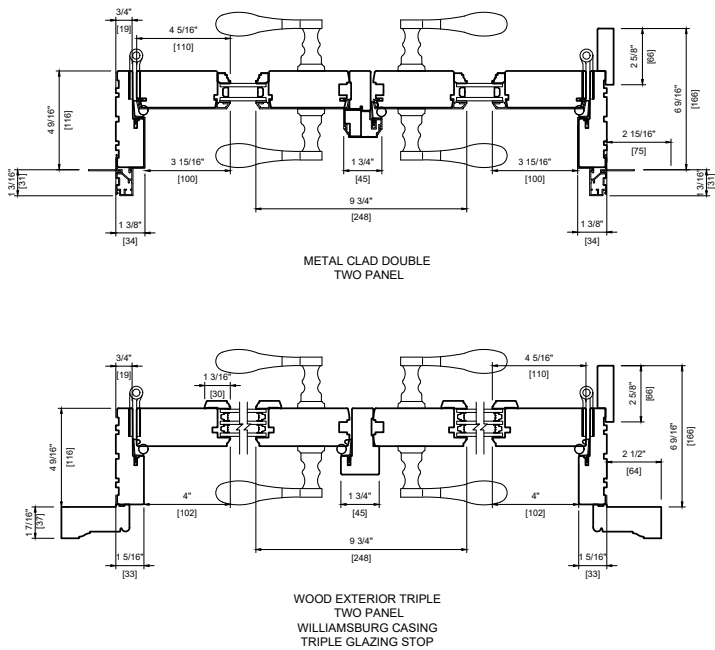
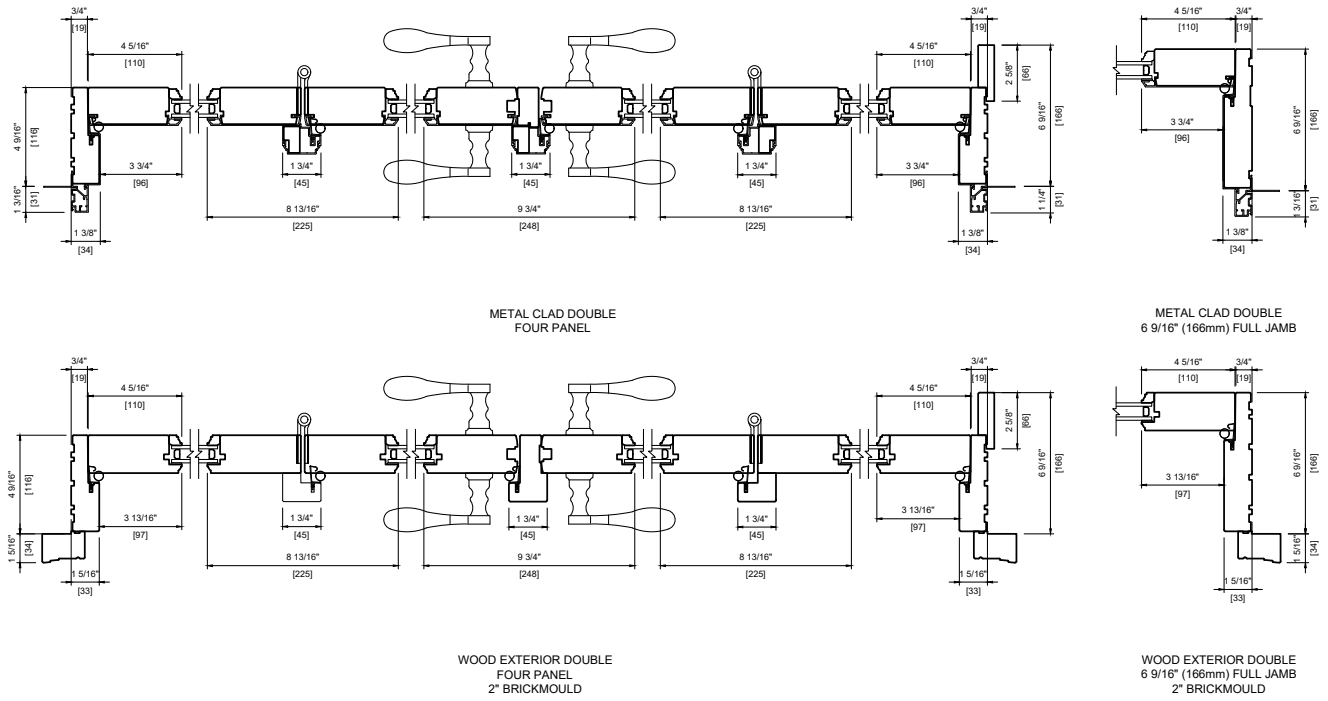

GLAZING STOP PROFILES

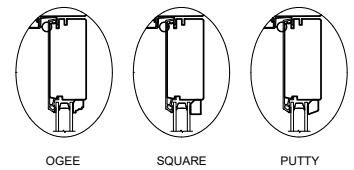

Casing

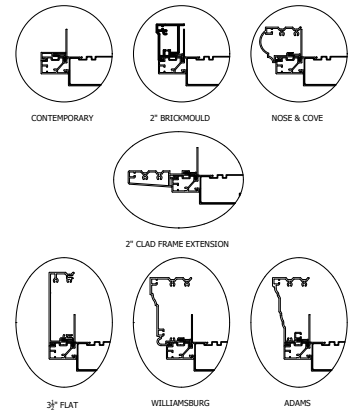

Swinging Terrace & French Doors -
1.75 Inch - **Standard Stile (>3")** FD

Drawings

Outswing

HEAD & SILL DETAILS

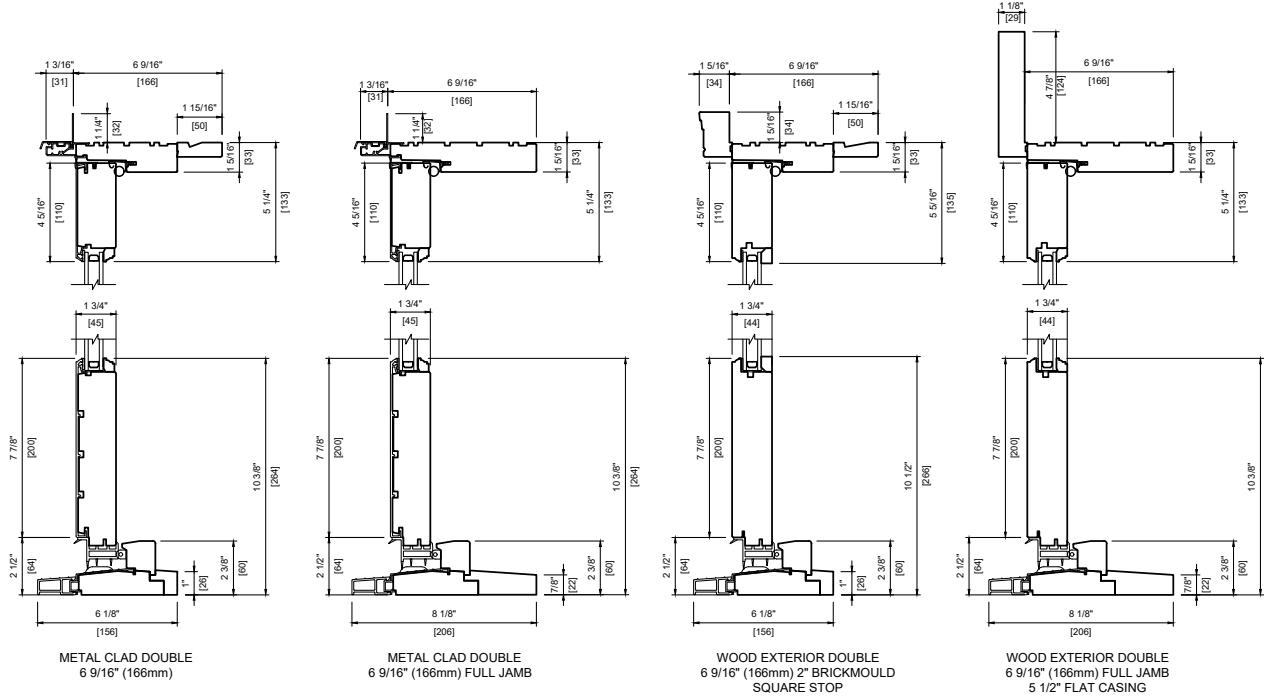

HEAD & SILL DETAILS

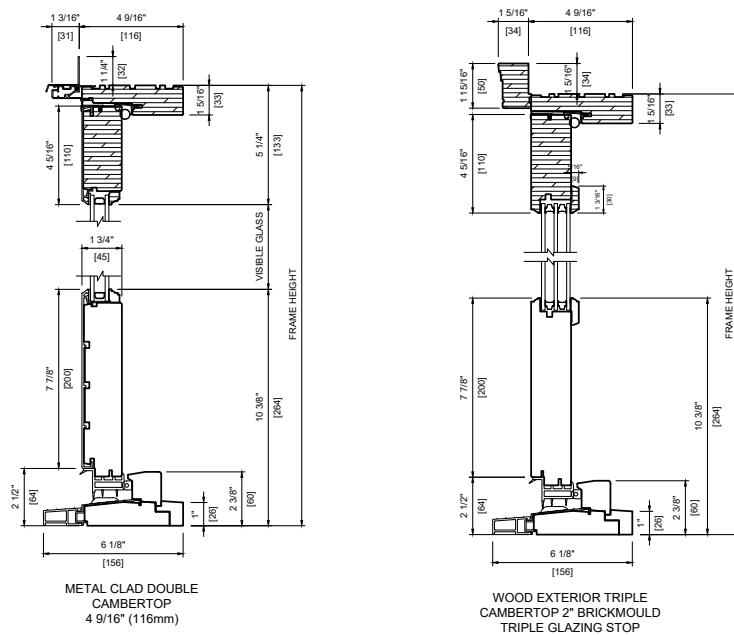

GLAZING STOP PROFILES

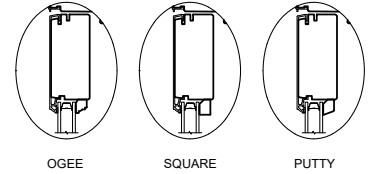

Casing

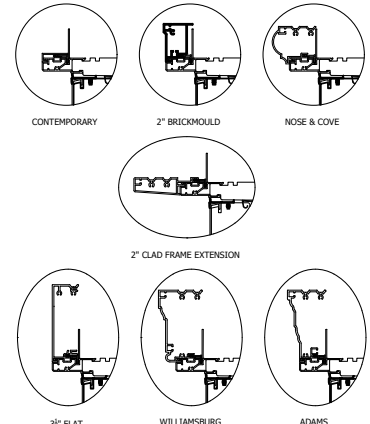

Swinging Terrace & French Doors -
1.75 Inch - **Standard Stile (>3")** FD

Drawings

Outswing (cont'd)

PLAN VIEW

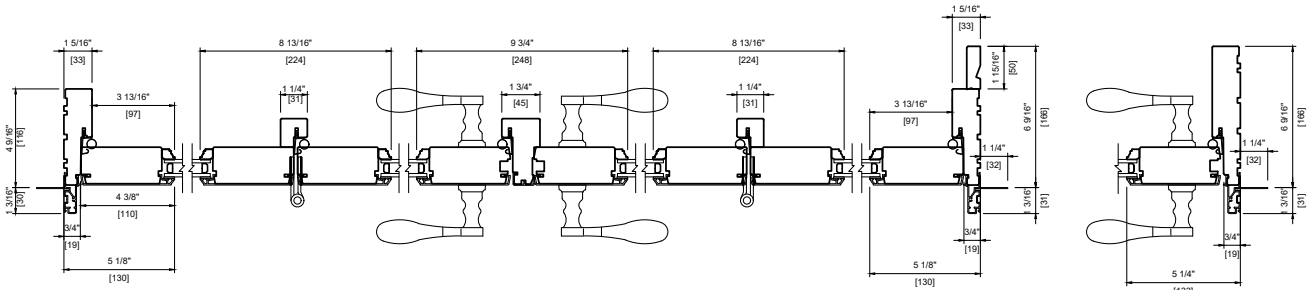

METAL CLAD DOUBLE
FOUR PANEL

METAL CLAD DOUBLE
6 9/16" (166mm) FULL JAMB

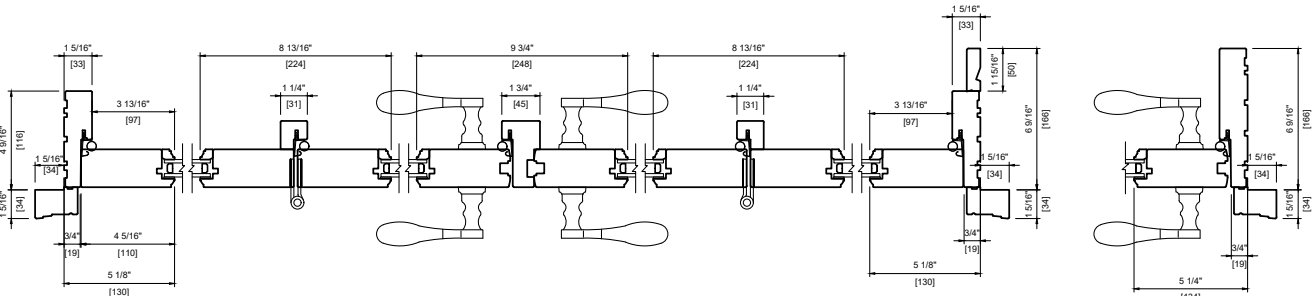

WOOD EXTERIOR DOUBLE
FOUR PANEL
2" BRICKMOULD

WOOD EXTERIOR DOUBLE
6 9/16" (166mm) FULL JAMB
2" BRICKMOULD

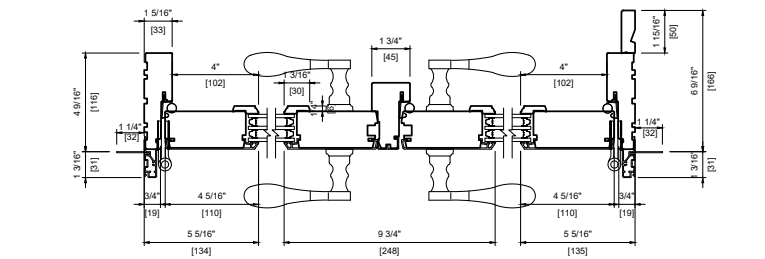

METAL CLAD TRIPLE
TWO PANEL
TRIPLE GLAZING STOP

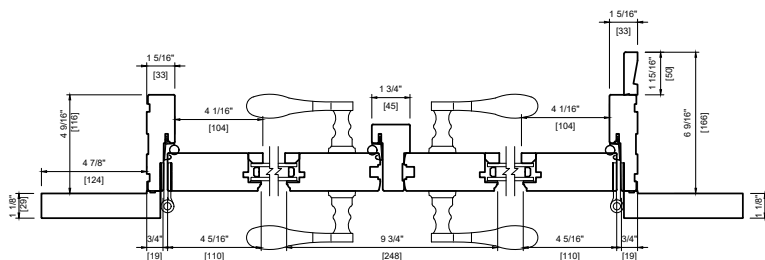

WOOD EXTERIOR DOUBLE
TWO PANEL
5 1/2" FLAT CASING
SQUARE STOP

GLAZING STOP PROFILES

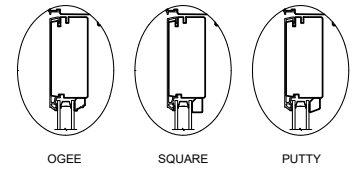

Casing

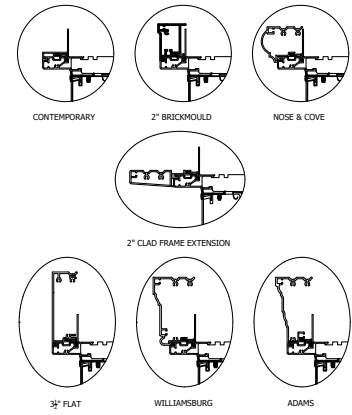

Swinging Terrace & French Doors -
1.75 Inch - **Standard Stile (>3")** FD

Drawings

3 Wide Inswing & Outswing

PLAN VIEW
INSWING

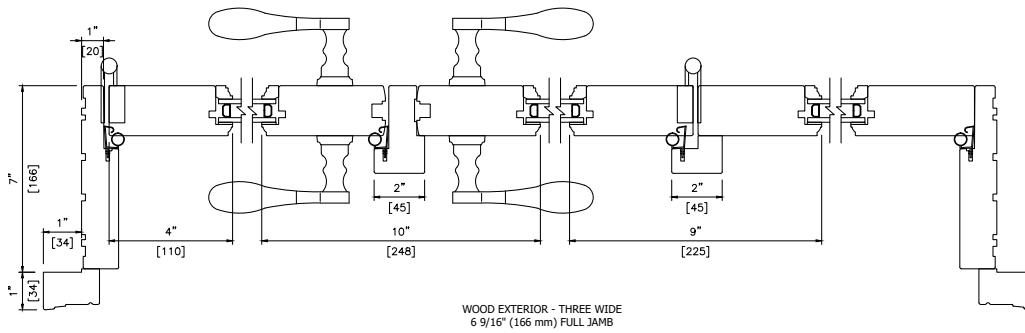
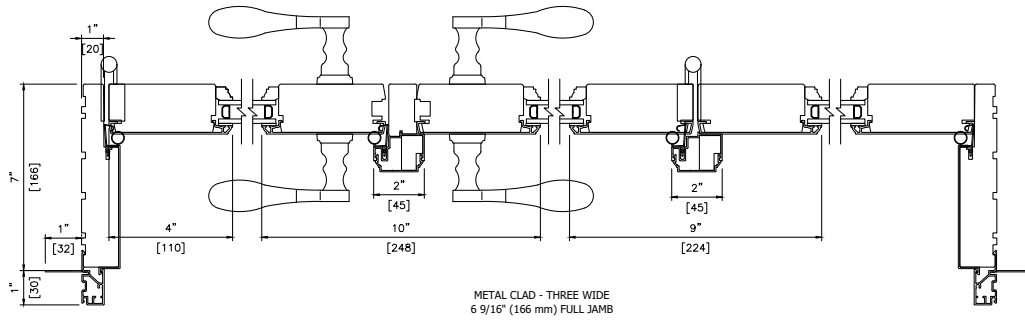

PLAN VIEW
OUTSWING

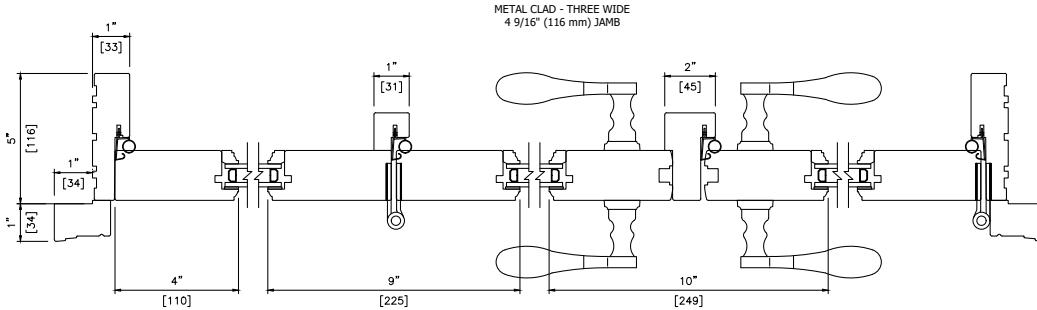
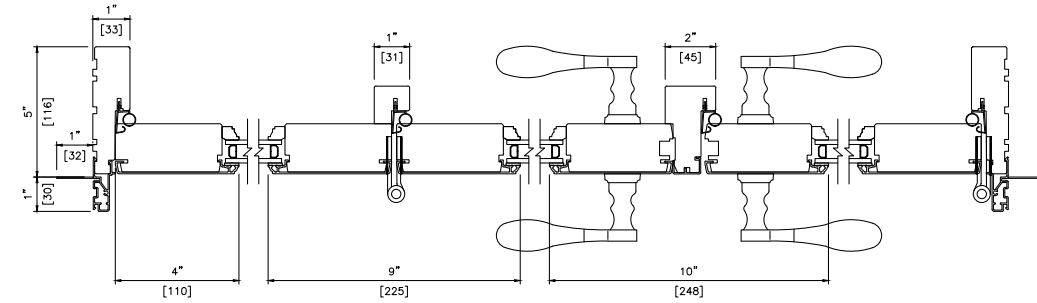

Swinging Terrace & French Doors -
1.75 Inch - **Standard Stile (>3") FD**

Drawings

Transom

HEAD & SILL DETAIL

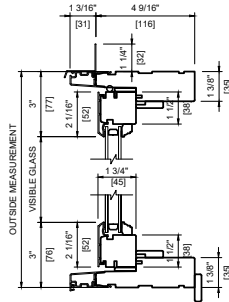

METAL CLAD DOUBLE
2 1/16" (52mm) RAILS

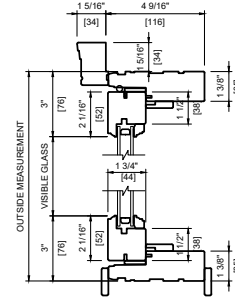

WOOD EXTERIOR DOUBLE
2 1/16" (52mm) RAILS
2" BRICKMOULD

PLAN VIEW

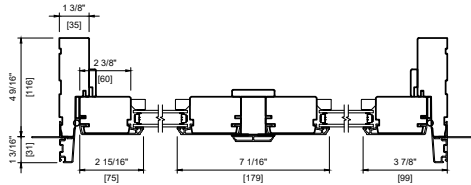

METAL CLAD NARROW STILE
3" (75mm) STILES

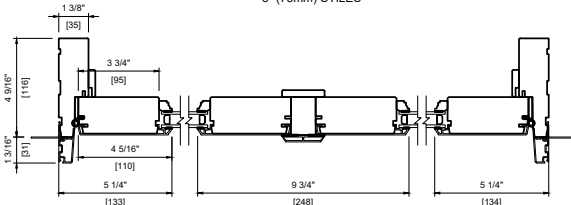

METAL CLAD STANDARD STILE
4 5/16" (110mm) STILES

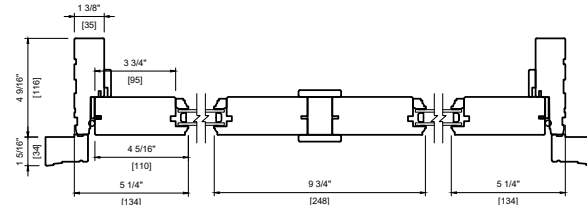

WOOD EXTERIOR STANDARD STILE
4 5/16" (110mm) STILES

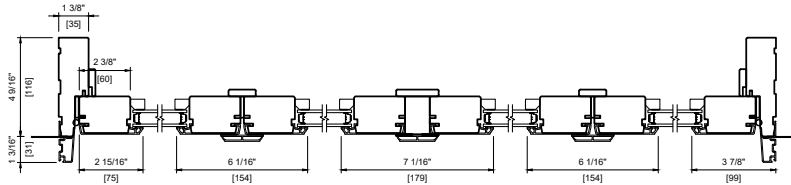

METAL CLAD NARROW STILE
3" (75mm) STILES

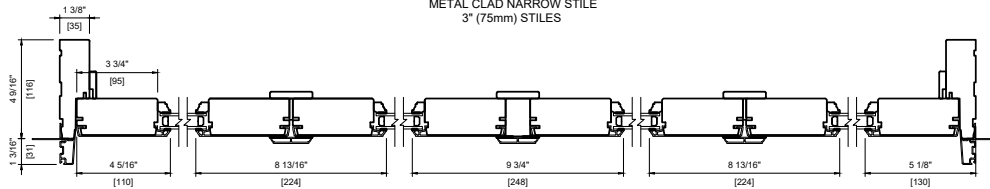

METAL CLAD STANDARD STILE
4 5/16" (110mm) STILES

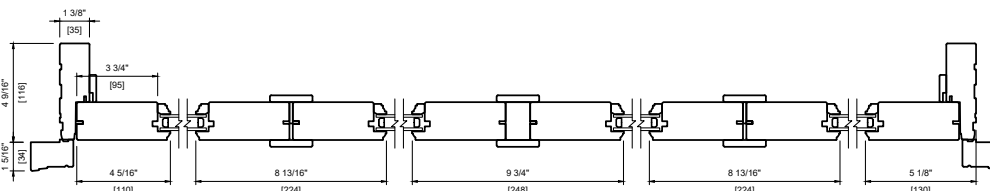

WOOD EXTERIOR STANDARD STILE
4 5/16" (110mm) STILES

Swinging Terrace & French Doors -
1.75 Inch - **Standard Stile (>3")** FD

Drawings

Mull & Sidelite

HEAD & SILL DETAILS

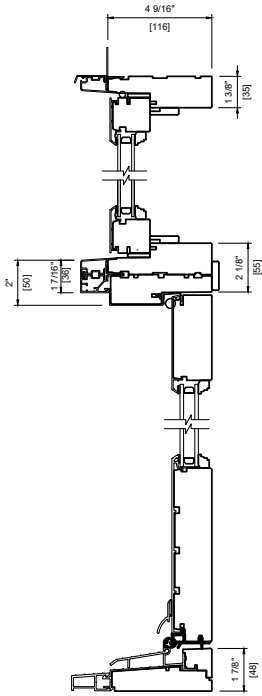

METAL CLAD DOUBLE
TRANSOM over INSWING DOOR

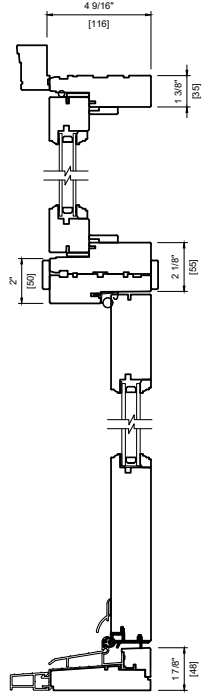

WOOD EXTERIOR DOUBLE
TRANSOM over INSWING DOOR
2" BRICKMOULD

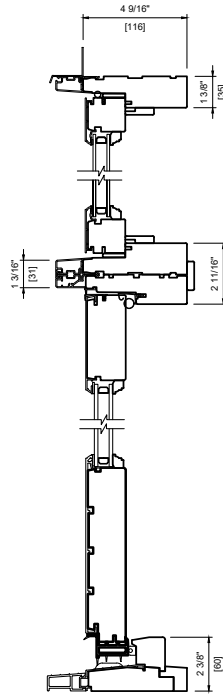

METAL CLAD DOUBLE
TRANSOM over OUTSWING DOOR

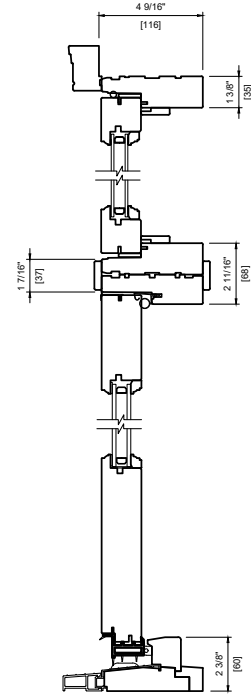

WOOD EXTERIOR DOUBLE
TRANSOM over OUTSWING DOOR
2" BRICKMOULD

PLAN VIEW

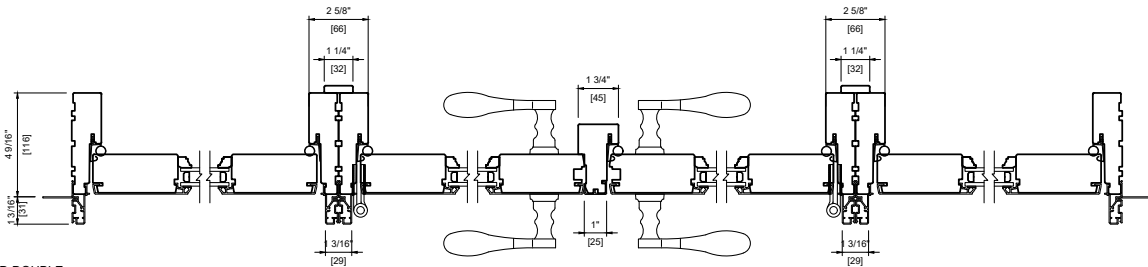

METAL CLAD DOUBLE
SIDELITES BESIDE
OUTSWING FRENCH TERRACE DOOR

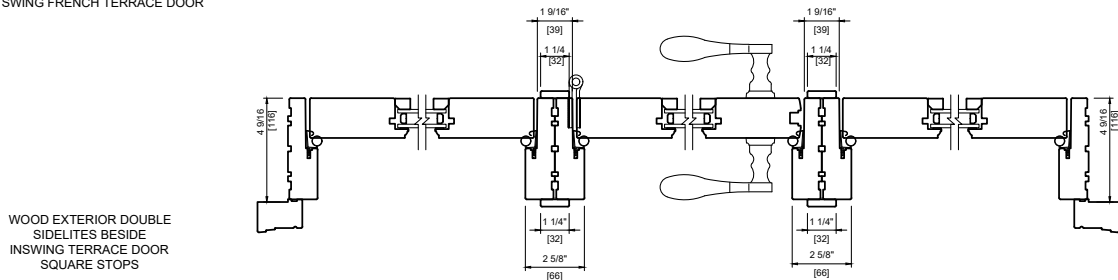

WOOD EXTERIOR DOUBLE
SIDELITES BESIDE
INSWING TERRACE DOOR
SQUARE STOPS

Swinging Terrace & French Doors -
1.75 Inch - **Standard Stile (>3")** FD

Drawings

Flat Sill, Mid Rail & Bottom Rail

HEAD & SILL DETAILS

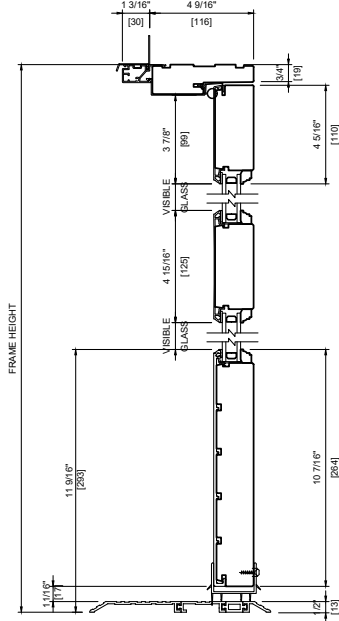

METAL CLAD DOUBLE
INSWING

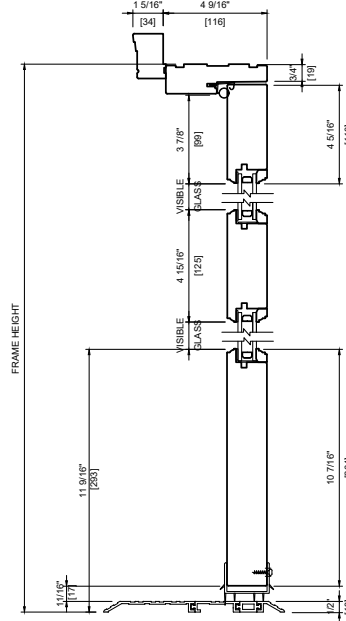

WOOD EXTERIOR DOUBLE
INSWING

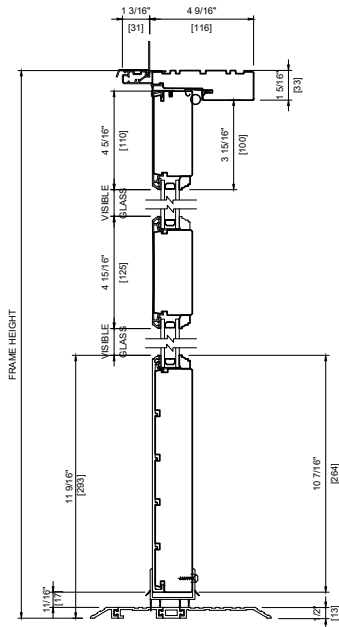

METAL CLAD DOUBLE
OUTSWING

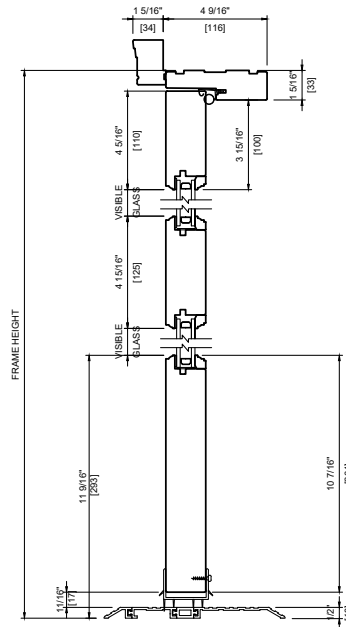

WOOD EXTERIOR DOUBLE
OUTSWING

Swinging Terrace & French Doors -
1.75 Inch - **Standard Stile (>3") FD**

Drawings

Wall Connection

HEAD & SILL DETAIL

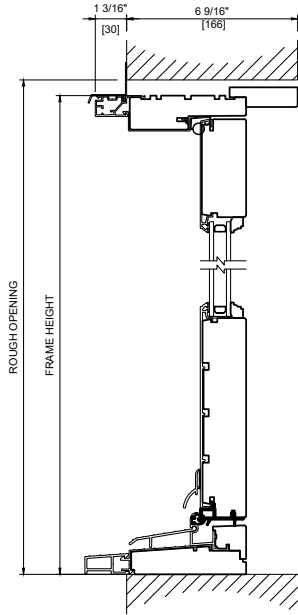

METAL CLAD
6 9/16" (166mm)

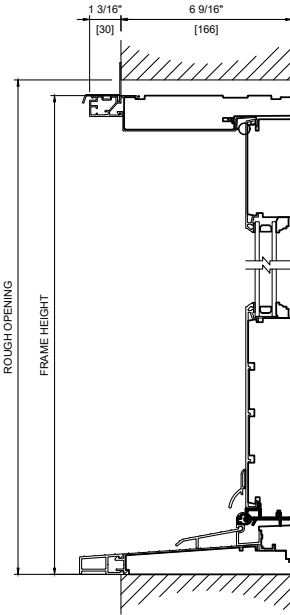

METAL CLAD
6 9/16" (166mm) FULL JAMB

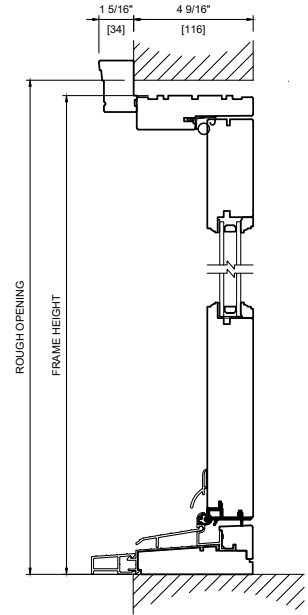

NON CLAD
4 9/16" (116mm) 2" BRICKMOULD

PLAN VIEW

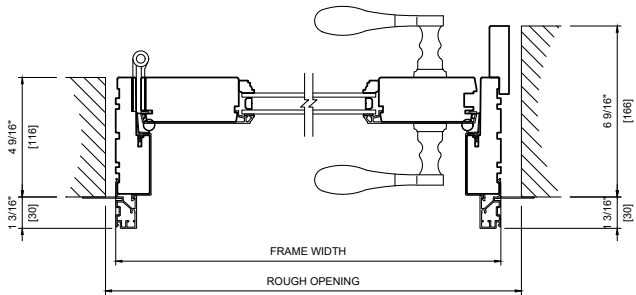

METAL CLAD
4 9/16" & 6 9/16" (116mm & 166mm)

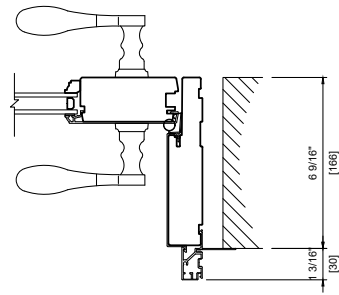

METAL CLAD
6 9/16" (166mm) FULL JAMB

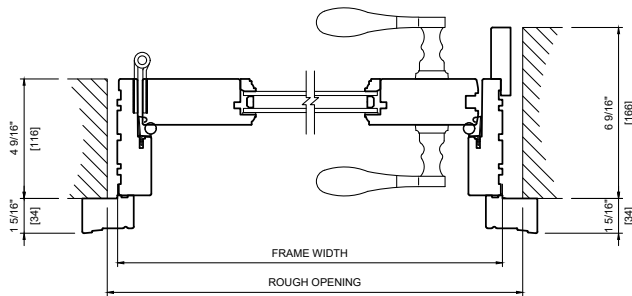

NON CLAD
4 9/16" & 6 9/16" (116mm & 166mm)
2" BRICKMOULD

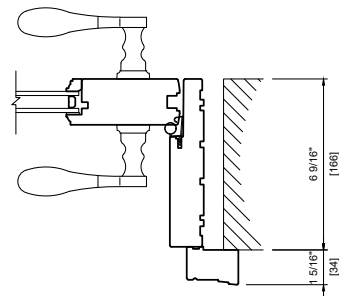

NON CLAD
6 9/16" (166mm) FULL JAMB
2" BRICKMOULD

Swinging Terrace & French Doors -
1.75 Inch - 10' TD & FD

Size Charts

10' TD & FD

Width

Height

Rough Opening Inswing with Jamb Extension					31 7/8" [809]	35 1/8" [892]	37 3/4" [959]	39 5/16" [999]	43 1/4" [1099]	45 1/4" [1150]
Rough Opening					31 1/4" [793]	34 1/2" [876]	37 1/8" [943]	38 11/16" [983]	42 5/8" [1083]	44 5/8" [1134]
Frame					30 1/2" [774]	33 3/4" [857]	36 3/8" [924]	37 15/16" [964]	41 7/8" [1064]	43 7/8" [1115]
Panel					28 9/16" [726]	31 7/8" [809]	34 1/2" [876]	36 1/16" [916]	40" [1016]	42" [1067]
Visible Glass					16 7/8" [428]	20 1/8" [511]	22 3/4" [578]	24 5/16" [618]	28 1/4" [718]	30 1/4" [769]
124 5/16" [3157]	124" [3150]	123 7/16" [3135]	120 3/8" [3057]	106 1/4" [2699]	TD1 0732	TD1 0832	TD1 0932	TD1 0932	TD1 1032	TD1 1132

Width

Height

Rough Opening Inswing with Jamb Extension								75 3/8" [1915]	83 1/4" [2115]	87 5/16" [2217]
Rough Opening								74 3/4" [1899]	82 5/8" [2099]	86 5/8" [2201]
Frame								70 7/8" [1880]	81 7/8" [2080]	85 7/8" [2182]
Panel								36 1/16" [916]	40" [1016]	42" [1067]
Visible Glass								24 5/16" [618]	28 1/4" [718]	30 1/4" [769]
124 5/16" [3157]	124" [3150]	123 7/16" [3135]	120 3/8" [3057]	106 1/4" [2699]				TD2 1832	TD2 2032	TD2 2232

Width

Height

Rough Opening Inswing with Jamb Extension					47 7/8" [1216]	61 9/16" [1564]	68 1/2" [1730]	72 1/8" [2246]	76 3/8" [1940]	84 7/16" [2144]	88 7/16" [2246]
Rough Opening					47 1/4" [1200]	60 3/16" [1548]	67 1/2" [1714]	72 3/4" [2230]	75 3/4" [1924]	83 3/4" [2128]	87 13/16" [2230]
Frame					46 1/2" [1181]	60 3/16" [1529]	66 3/4" [1695]	72" [1829]	75" [1905]	83 1/16" [2109]	87 1/16" [2211]
Panel					21 3/4" [552]	28 9/162" [726]	31 7/8" [809]	34 1/2" [876]	36" [914]	40" [1016]	42" [1067]
Visible Glass					10" [254]	16 7/8" [428]	20 1/8" [511]	22 3/4" [578]	24 1/4" [616]	28 1/4" [718]	30 1/4" [769]
124 5/16" [3157]	124" [3150]	123 7/16" [3135]	120 3/8" [3057]	106 1/4" [2699]	FD2 1232	FD2 1532	FD2 1632	FD2 1832	FD2 1832	FD2 2032	FD2 2232

Swinging Terrace & French Doors -
1.75 Inch - 10' TD & FD

Drawings

Inswing

HEAD & SILL DETAILS

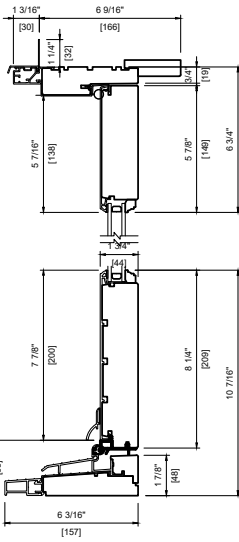

METAL CLAD DOUBLE
6 9/16" (166mm)

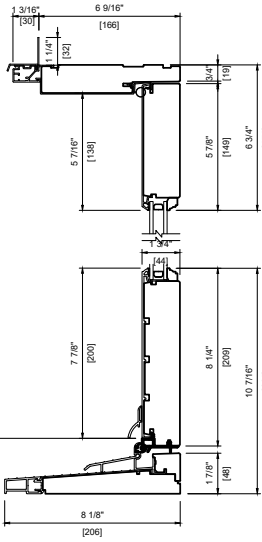

METAL CLAD DOUBLE
6 9/16" (166mm) FULL JAMB

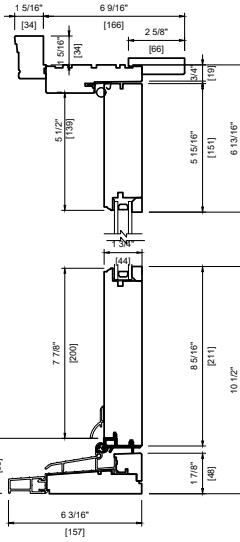

WOOD EXTERIOR DOUBLE
6 9/16" (166mm) 2" BRICKMOULD
SQUARE STOP

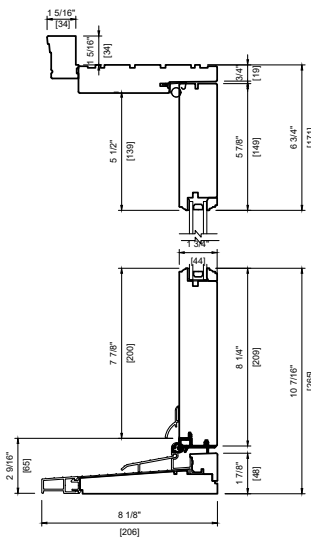

WOOD EXTERIOR DOUBLE
6 9/16" (166mm) FULL JAMB
2" BRICKMOULD

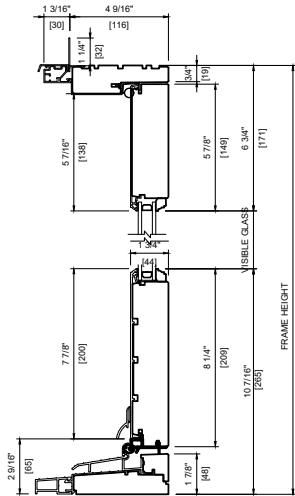

METAL CLAD DOUBLE
4 9/16" (116mm)

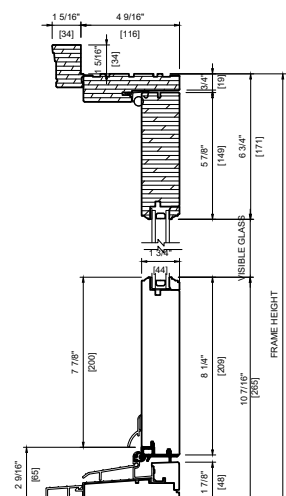

CAMBER/ROUNDTOP
WOOD EXTERIOR DOUBLE
4 9/16" (116mm)
2" BRICKMOULD

GLAZING STOP PROFILES

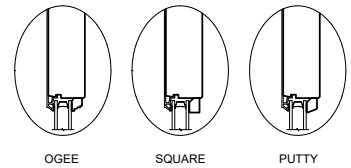

Casing

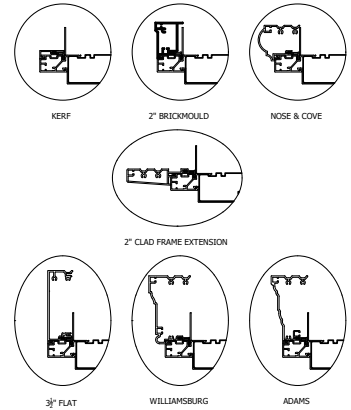

Swinging Terrace & French Doors -
1.75 Inch - 10' TD & FD

Drawings

Inswing (TD Plan View)

PLAN VIEW

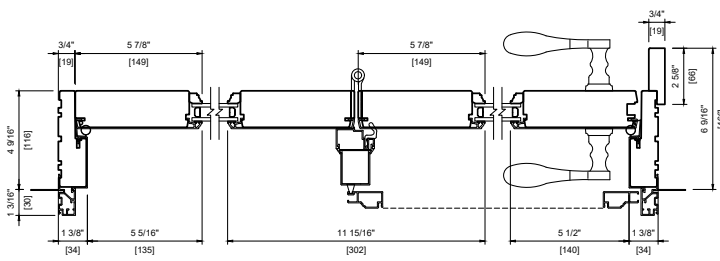

METAL CLAD DOUBLE
TWO PANEL

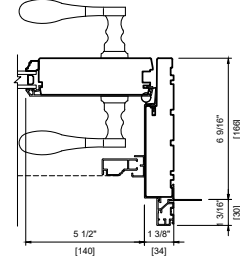

METAL CLAD DOUBLE
6 9/16" (166 mm) FULL JAMB

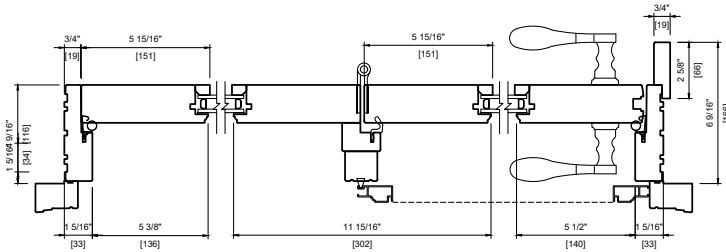

WOOD EXTERIOR DOUBLE
TWO PANEL 2" BRICKMOULD
SQUARE STOP

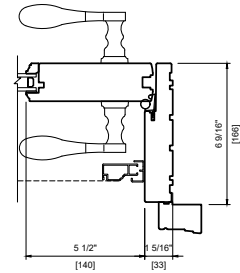

WOOD EXTERIOR DOUBLE
6 9/16" (166 mm) FULL JAMB
2" BRICKMOULD

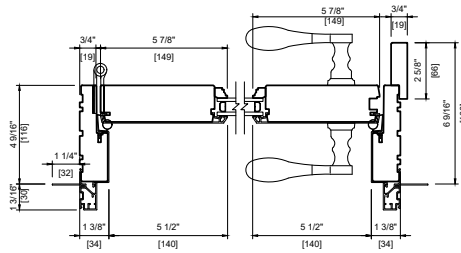

METAL CLAD DOUBLE
ONE PANEL

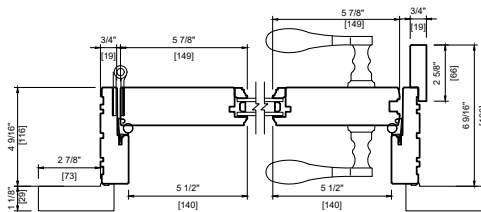

NON CLAD DOUBLE
ONE PANEL
3 1/2" FLAT CASING

GLAZING STOP PROFILES

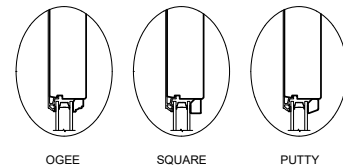

Casing

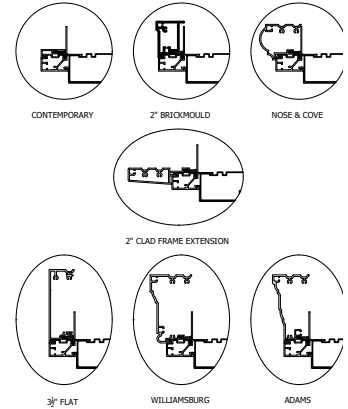

Swinging Terrace & French Doors -
1.75 Inch - 10' TD & FD

Drawings

Outswing

HEAD & SILL DETAILS

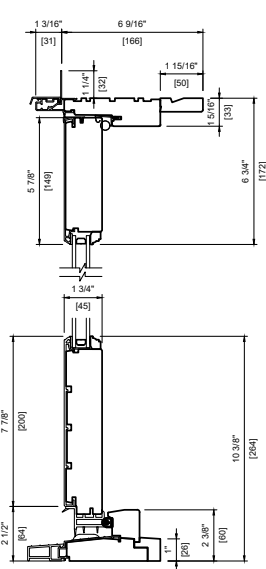

METAL CLAD DOUBLE
6 9/16" (166mm)

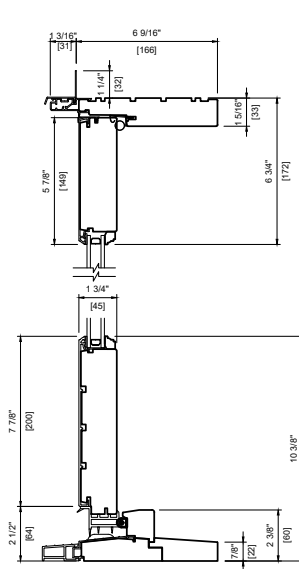

METAL CLAD DOUBLE
6 9/16" (166mm) FULL JAMB

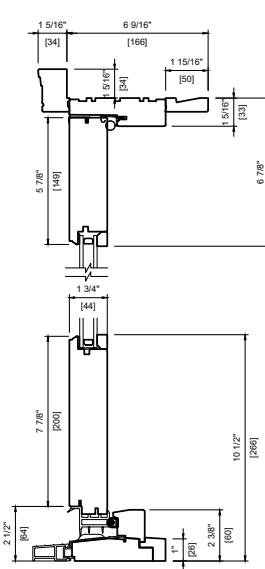

WOOD EXTERIOR DOUBLE
6 9/16" (166mm) 2" BRICKMOULD
SQUARE STOP

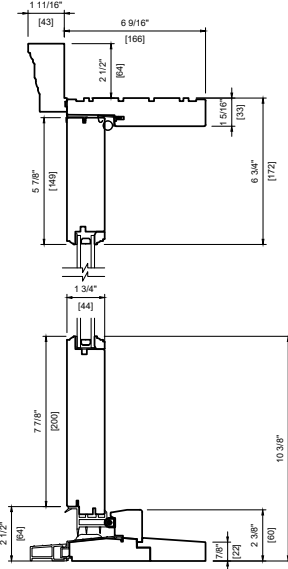

WOOD EXTERIOR DOUBLE
6 9/16" (166mm) FULL JAMB
ADAMS CASING

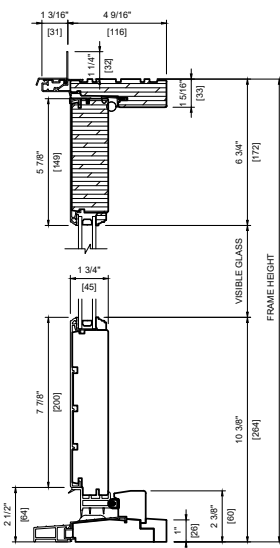

CAMBERTOP
METAL CLAD DOUBLE
4 9/16" (116mm)

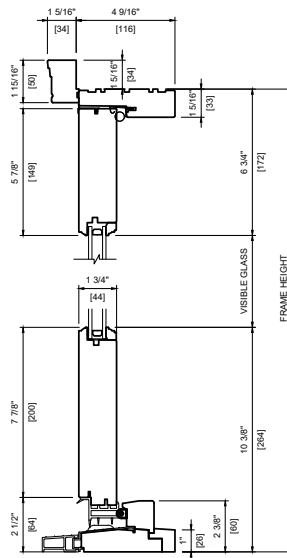

WOOD EXTERIOR DOUBLE
4 9/16" (116mm)
2" BRICKMOULD

GLAZING STOP PROFILES

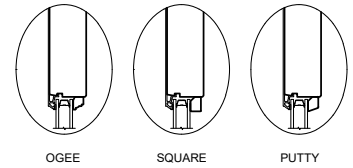

Casing

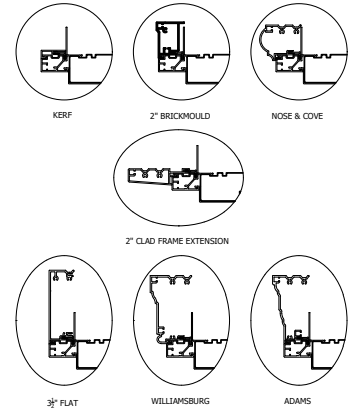

Swinging Terrace & French Doors -
1.75 Inch - 10' TD & FD

Drawings

Outswing (TD Plan View)

PLAN VIEW

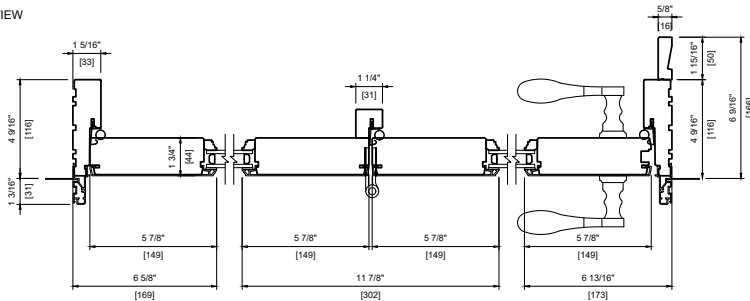

METAL CLAD DOUBLE
TWO PANEL

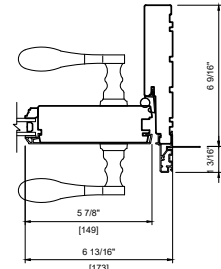

METAL CLAD DOUBLE
6 9/16" (166 mm) FULL JAMB

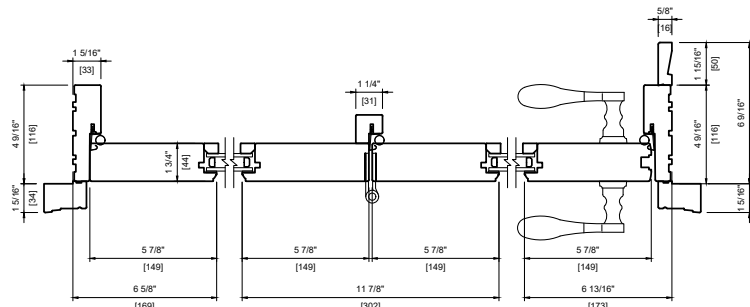

WOOD EXTERIOR DOUBLE
TWO PANEL 2" BRICKMOULD
SQUARE STOP

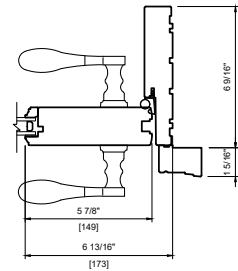

WOOD EXTERIOR DOUBLE
6 9/16" (166 mm) FULL JAMB
2" BRICKMOULD

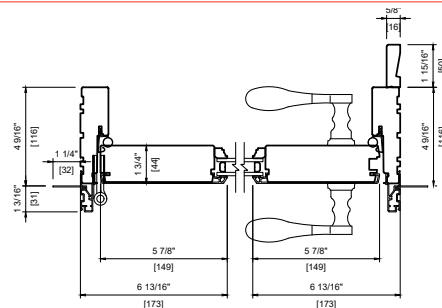

METAL CLAD DOUBLE
ONE PANEL

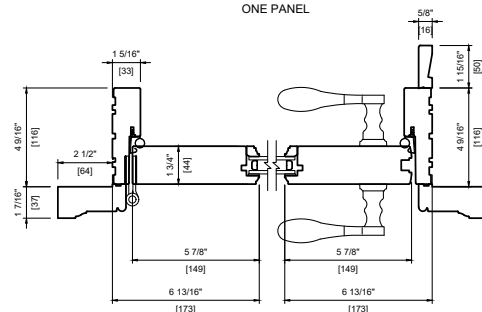

WOOD EXTERIOR DOUBLE
ONE PANEL
WILLIAMSBURG CASING

GLAZING STOP PROFILES

J29

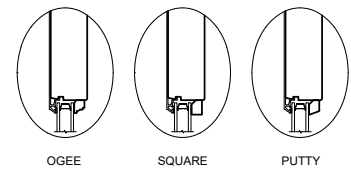

Casing

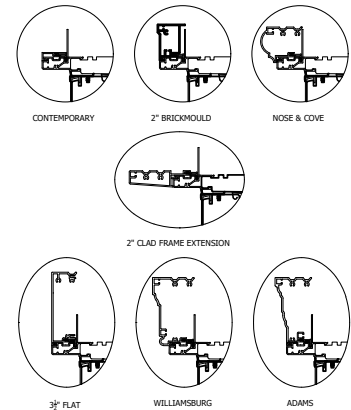

Swinging Terrace & French Doors -
1.75 Inch - 10' TD & FD

Drawings

Inswing & Outswing (FD Plan View)

PLAN VIEW OUTSWING

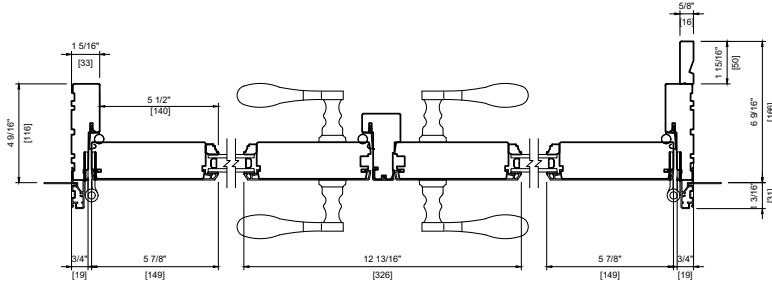

METAL CLAD DOUBLE
TWO PANEL

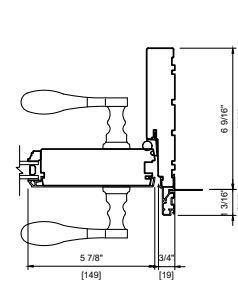

METAL CLAD DOUBLE
6 9/16" FULL JAMB

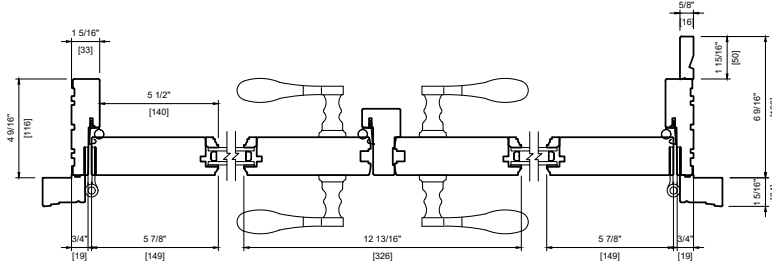

WOOD EXTERIOR DOUBLE
TWO PANEL
2" BRICKMOULD

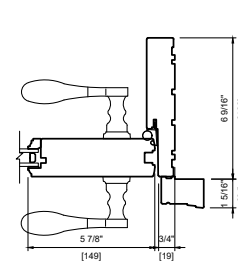

WOOD EXTERIOR DOUBLE
6 9/16" FULL JAMB
2" BRICKMOULD

PLAN VIEW INSWING

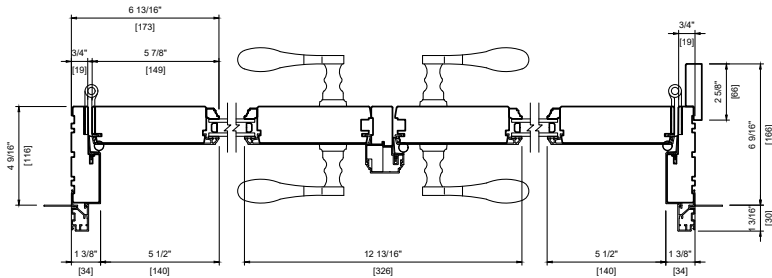

METAL CLAD DOUBLE
TWO PANEL

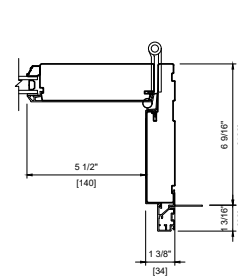

METAL CLAD DOUBLE
6 9/16" FULL JAMB

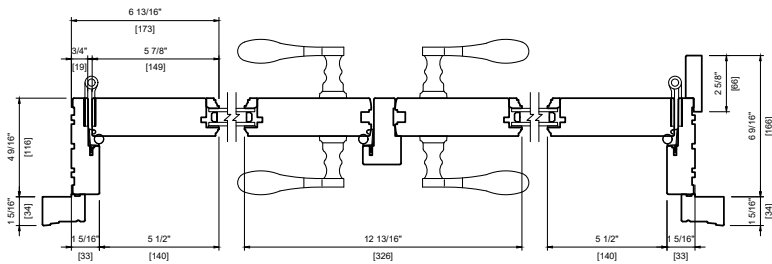

WOOD EXTERIOR DOUBLE
TWO PANEL
2" BRICKMOULD

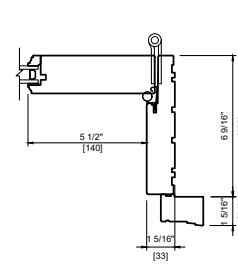

WOOD EXTERIOR DOUBLE
6 9/16" FULL JAMB
2" BRICKMOULD

Swinging Terrace & French Doors -
2.25 Inch - **Narrow Stile (3") TD**

Size Charts

TD1 Metal-Clad

Width

Height

Rough Opening				Width					
				Frame		Panel			
				Panel		Visible Glass			
				Visible Glass		Visible Glass			
				24 3/8" [619]	31 1/4" [793]	34 1/2" [876]	37 1/8" [943]	41 1/16" [1043]	44 5/8" [1134]
				23 5/8" [600]	30 1/2" [774]	33 3/4" [857]	36 3/8" [924]	40 5/16" [1024]	43 7/8" [1115]
				21 3/4" [552]	28 9/16" [726]	31 7/8" [809]	34 1/2" [876]	38 7/16" [976]	42" [1067]
				15 13/16" [402]	22 11/16" [576]	25 15/16" [659]	28 9/16" [726]	32 1/2" [826]	36 1/8" [917]
				TRANSOM					
16 1/2" [419]	15 3/4" [400]	13 7/8" [352]	9 11/16" [246]	*TDT1 0604	*TDT1 0704	*TDT1 0804	*TDT1 0904	*TDT1 1004	*TDT1 1104
24 3/8" [619]	23 5/8" [600]	21 3/4" [552]	17 9/16" [446]	*TDT1 0606	*TDT1 0706	*TDT1 0806	*TDT1 0906	*TDT1 1006	*TDT1 1106
32 1/4" [819]	31 1/2" [800]	29 5/8" [752]	25 7/16" [646]	*TDT1 0608	*TDT1 0708	*TDT1 0808	*TDT1 0908	*TDT1 1008	*TDT1 1108
				DOORS					
80 1/8" [2035]	79 1/2" [2020]	76 7/16" [1942]	68 13/16" [1748]	~TD1 0620	TD1 0720	TD1 0820	TD1 0920	TD1 1020	TD1 1120
81 7/8" [2080]	81 5/16" [2065]	78 1/4" [1987]	70 9/16" [1793]	~TD1 0621	TD1 0721	TD1 0821	TD1 0921	TD1 1021	TD1 1121
86 9/16" [2199]	86" [2184]	82 15/16" [2106]	75 1/4" [1912]	~TD1 0670	TD1 0770	TD1 0870	TD1 0970	TD1 1070	TD1 1170
95 1/16" [2415]	94 1/2" [2400]	91 7/16" [2322]	83 3/4" [2128]	~TD1 0624	TD1 0724	TD1 0824	TD1 0924	TD1 1024	TD1 1124
98" [2489]	97 3/8" [2474]	94 5/16" [2396]	86 11/16" [2202]	~TD1 0680	TD1 0780	TD1 0880	TD1 0980	TD1 1080	TD1 1180
99 5/8" [2531]	99 1/16" [2516]	96" [2438]	88 3/8" [2244]	~TD1 0625	TD1 0725	TD1 0825	TD1 0925	TD1 1025	TD1 1125
106 7/8" [2715]	106 5/16" [2700]	103 1/4" [2622]	95 9/16" [2428]	~TD1 0627	TD1 0727	TD1 0827	TD1 0927	TD1 1027	TD1 1127
124" [3150]	123 7/16" [3135]	120 3/8" [3057]	112 11/16" [2863]	~TD1 0632	TD1 0732	TD1 0832	TD1 0932	TD1 1032	TD1 1132

* Transom
~ Fixed Sidelite

Swinging Terrace & French Doors -
2.25 Inch - **Narrow Stile (3") TD**

Size Charts

TD1 Non-Clad

Width

Height

Rough Opening				Width					
				Frame					
				Panel					
				Visible Glass					
				24 3/8" [619]	31 1/4" [793]	34 1/2" [876]	37 1/8" [943]	41 1/16" [1043]	44 5/8" [1134]
				23 5/8" [600]	30 1/2" [774]	33 3/4" [857]	36 3/8" [924]	40 5/16" [1024]	43 7/8" [1115]
				28 9/16" [725]	28 1/2" [724]	31 3/4" [807]	34 7/16" [874]	38 3/8" [974]	41 15/16" [1065]
				22 5/8" [575]	22 5/8" [574]	25 7/8" [657]	28 1/2" [724]	32 7/16" [824]	36" [915]
				TRANSOM					
16 1/2" [419]	15 3/4" [400]	13 13/16" [351]	9 5/8" [245]	*TDT1 0604	*TDT1 0704	*TDT1 0804	*TDT1 0904	*TDT1 1004	*TDT1 1104
24 3/86" [619]	23 5/8" [600]	21 11/16" [551]	17 1/2" [445]	*TDT1 0606	*TDT1 0706	*TDT1 0806	*TDT1 0906	*TDT1 1006	*TDT1 1106
32 1/4" [819]	31 1/2" [800]	29 9/16" [751]	25 3/8" [645]	*TDT1 0608	*TDT1 0708	*TDT1 0808	*TDT1 0908	*TDT1 1008	*TDT1 1108
				DOORS					
80 1/8" [2035]	79 1/2" [2020]	77" [1956]	69 3/4" [1771]	~TD1 0620	TD1 0720	TD1 0820	TD1 0920	TD1 1020	TD1 1120
81 7/8" [2080]	81 5/16" [2065]	78 3/4" [2001]	71 1/2" [1816]	~TD1 0621	TD1 0721	TD1 0821	TD1 0921	TD1 1021	TD1 1121
86 9/16" [2199]	86" [2184]	83 7/16" [2120]	76 3/16" [1935]	~TD1 0670	TD1 0770	TD1 0870	TD1 0970	TD1 1070	TD1 1170
95 1/16" [2415]	94 1/2" [2400]	91 15/16" [2336]	84 11/16" [2151]	~TD1 0624	TD1 0724	TD1 0824	TD1 0924	TD1 1024	TD1 1124
98" [2489]	97 3/8" [2474]	94 7/8" [2410]	87 5/8" [2225]	~TD1 0680	TD1 0780	TD1 0880	TD1 0980	TD1 1080	TD1 1180
99 5/8" [2531]	99 1/16" [2516]	96 9/16" [2452]	89 1/4" [2267]	~TD1 0625	TD1 0725	TD1 0825	TD1 0925	TD1 1025	TD1 1125
106 7/8" [2715]	106 5/16" [2700]	103 3/4" [2636]	96 1/2" [2451]	~TD1 0627	TD1 0727	TD1 0827	TD1 0927	TD1 1027	TD1 1127
124" [3150]	123 7/16" [3135]	120 7/8" [3071]	113 5/8" [2886]	~TD1 0632	TD1 0732	TD1 0832	TD1 0932	TD1 1032	TD1 1132

* Transom
~ Fixed Sidelite

Swinging Terrace & French Doors -
2.25 Inch - **Narrow Stile (3") TD**

Size Charts

TD2 Metal-Clad

Width

Height

Rough Opening				Width								
				Frame				59 13/16" [1519]	66 5/16" [1685]	71 5/8" [1819]	79 1/2" [2019]	86 5/8" [2201]
				Panel			59 1/16" [1500]	65 9/16" [1666]	70 7/8" [1800]	78 3/4" [2000]	85 7/8" [2182]	
				Visible Glass	28 1/2" [724]	31 3/4" [807]	34 7/16" [874]	38 3/8" [974]	41 15/16" [1065]			
				22 5/8" [574]	25 7/8" [657]	28 1/2" [724]	32 7/16" [824]	36" [915]				
				TRANSOM								
16 1/2" [419]	15 3/4" [400]	13 7/8" [352]	9 11/16" [246]	*TDT2 1504	*TDT2 1604	*TDT2 1804	*TDT2 2004	*TDT2 2204				
24 3/8" [619]	23 5/8" [600]	21 3/4" [552]	17 9/16" [446]	*TDT2 1506	*TDT2 1606	*TDT2 1806	*TDT2 2006	*TDT2 2206				
32 1/4" [819]	31 1/2" [800]	29 5/8" [752]	25 7/16" [646]	*TDT2 1508	*TDT2 1608	*TDT2 1808	*TDT2 2008	*TDT2 2208				
				DOORS								
80 1/8" [2035]	79 1/2" [2020]	76 7/16" [1942]	68 13/16" [1748]	TD2 1520	TD2 1620	TD2 1820	TD2 2020	TD2 2220				
81 7/8" [2080]	81 5/16" [2065]	78 1/4" [1987]	70 9/16" [1793]	TD2 1521	TD2 1621	TD2 1821	TD2 2021	TD2 2221				
86 9/16" [2199]	86" [2184]	82 15/16" [2106]	75 1/4" [1912]	TD2 1570	TD2 1670	TD2 1870	TD2 2070	TD2 2270				
95 1/16" [2415]	94 1/2" [2400]	91 7/16" [2322]	83 3/4" [2128]	TD2 1524	TD2 1624	TD2 1824	TD2 2024	TD2 2224				
98" [2489]	97 3/8" [2474]	94 5/16" [2396]	86 11/16" [2202]	TD2 1580	TD2 1680	TD2 1880	TD2 2080	TD2 2280				
99 5/8" [2531]	99 1/16" [2516]	96" [243]8	88 3/8" [2244]	TD2 1525	TD2 1625	TD2 1825	TD2 2025	TD2 2225				
106 7/8" [2715]	106 5/16" [2700]	103 1/4" [2622]	95 9/16" [2428]	TD2 1527	TD2 1627	TD2 1827	TD2 2027	TD2 2227				
124" [3150]	123 7/16" [3135]	120 3/8" [3057]	112 11/16" [2863]	TD2 1532	TD2 1632	TD2 1832	TD2 2032	TD2 2232				

* Transom

Swinging Terrace & French Doors -
2.25 Inch - **Narrow Stile (3") TD**

Size Charts

TD2 Non-Clad

Width

Rough Opening												
				Frame								
				Panel								
				Visible Glass								
				59 13/16" [1519]	66 5/16" [1685]	71 5/8" [1819]	79 1/2" [2019]	86 5/8" [2201]				
				59 1/16" [1500]	65 9/16" [1666]	70 7/8" [1800]	78 3/4" [2000]	85 7/8" [2182]				
				28 1/2" [724]	31 3/4" [807]	34 7/16" [874]	38 3/8" [974]	41 15/16" [1065]				
				22 5/8" [574]	25 7/8" [657]	28 1/2" [724]	32 7/16" [824]	36" [915]				
				TRANSOM								
16 5/16" [415]	15 3/4" [400]	13 7/8" [352]	9 11/16" [246]	*TDT2 1504	*TDT2 1604	*TDT2 1804	*TDT2 2004	*TDT2 2204				
24 3/16" [615]	23 5/8" [600]	21 3/4" [552]	17 9/16" [446]	*TDT2 1506	*TDT2 1606	*TDT2 1806	*TDT2 2006	*TDT2 2206				
32 1/4" [819]	31 1/2" [800]	29 9/16" [751]	25 3/8" [645]	*TDT2 1508	*TDT2 1608	*TDT2 1808	*TDT2 2008	*TDT2 2208				
				DOORS								
80 1/8" [2035]	79 1/2" [2020]	77" [1956]	69 3/4" [1771]	TD2 1520	TD2 1620	TD2 1820	TD2 2020	TD2 2220				
81 7/8" [2080]	81 5/16" [2065]	78 3/4" [2001]	71 1/2" [1816]	TD2 1521	TD2 1621	TD2 1821	TD2 2021	TD2 2221				
86 9/16" [2199]	86" [2184]	83 7/16" [2120]	76 3/16" [1935]	TD2 1570	TD2 1670	TD2 1870	TD2 2070	TD2 2270				
95 1/16" [2415]	94 1/2" [2400]	91 15/16" [2336]	84 11/16" [2151]	TD2 1524	TD2 1624	TD2 1824	TD2 2024	TD2 2224				
98" [2489]	97 3/8" [2474]	94 7/8" [2410]	87 5/8" [2225]	TD2 1580	TD2 1680	TD2 1880	TD2 2080	TD2 2280				
99 5/8" [2531]	99 1/16" [2516]	96 9/16" [2452]	89 1/4" [2267]	TD2 1525	TD2 1625	TD2 1825	TD2 2025	TD2 2225				
106 7/8" [2715]	106 5/16" [2700]	103 3/4" [2636]	96 1/2" [2451]	TD2 1527	TD2 1627	TD2 1827	TD2 2027	TD2 2227				
124" [3150]	123 7/16" [3135]	120 7/8" [3071]	113 5/8" [2886]	TD2 1532	TD2 1632	TD2 1832	TD2 2032	TD2 2232				

Height

* Transom

Swinging Terrace & French Doors -
2.25 Inch - **Narrow Stile (3") TD**

Size Charts

TD3 Metal-Clad

Rough Opening				Width								
				Frame				88 3/8" [2245]	98 3/16" [2494]	106 1/16" [2695]	117 7/8" [2995]	128 11/16" [3268]
				Panel			28 1/2" [723]	31 3/4" [806]	34 3/8" [873]	38 5/16" [973]	41 7/8" [1064]	
				Visible Glass		22 9/16" [573]	25 13/16" [656]	28 1/2" [723]	32 7/16" [823]	36" [914]		
				TRANSOM								
16 1/2" [419]	15 3/4" [400]	13 7/8" [352]	9 11/16" [246]	*TDT3 2204	*TDT3 2404	*TDT3 2704	*TDT3 3004	*TDT3 3004				
24 3/8" [619]	23 5/8" [600]	21 3/4" [552]	17 9/16" [446]	*TDT3 2206	*TDT3 2406	*TDT3 2706	*TDT3 3006	*TDT3 3006				
32 1/4" [819]	31 1/2" [800]	29 5/8" [752]	25 7/16" [646]	*TDT3 2208	*TDT3 2408	*TDT3 2708	*TDT3 3008	*TDT3 3008				
				DOORS								
80 1/8" [2035]	79 1/2" [2020]	76 7/16" [1942]	68 13/16" [1748]	TD3 2220	TD3 2420	TD3 2720	TD3 3020	TD3 3220				
81 7/8" [2080]	81 5/16" [2065]	78 1/4" [1987]	70 9/16" [1793]	TD3 2221	TD3 2421	TD3 2721	TD3 3021	TD3 3221				
86 9/16" [2199]	86" [2184]	82 15/16" [2106]	75 1/4" [1912]	TD3 2270	TD3 2470	TD3 2770	TD3 3070	TD3 3270				
95 1/16" [2415]	94 1/2" [2400]	91 7/16" [2322]	83 3/4" [2128]	TD3 2224	TD3 2424	TD3 2724	TD3 3024	TD3 3224				
98" [2489]	97 3/8" [2474]	94 5/16" [2396]	86 11/16" [2202]	TD3 2280	TD3 2480	TD3 2780	TD3 3080	TD3 3280				
99 5/8" [2531]	99 1/16" [2516]	96" [2438]	88 3/8" [2244]	TD3 2225	TD3 2425	TD3 2725	TD3 3025	TD3 3225				
106 7/8" [2715]	106 5/16" [2700]	103 1/4" [2622]	95 9/16" [2428]	TD3 2227	TD3 2427	TD3 2727	TD3 3027	TD3 3227				

* Transom

Swinging Terrace & French Doors -
2.25 Inch - **Narrow Stile (3") TD**

Size Charts

TD3 Non-Clad

				Width					
Height	Rough Opening				88 3/8" [2245]	98 3/16" [2494]	106 1/16" [2695]	117 7/8" [2995]	128 11/16" [3268]
	Frame				87 5/8" [2226]	97 7/16" [2475]	105 5/16" [2676]	117 1/8" [2976]	127 15/16" [3249]
	Panel				28 1/2" [723]	31 3/4" [806]	34 3/8" [873]	38 5/16" [973]	41 7/8" [1064]
	Visible Glass				22 9/16" [573]	25 13/16" [656]	28 1/2" [723]	32 7/16" [823]	36" [914]
					TRANSOM				
	16 5/16" [415]	15 3/4" [400]	13 7/8" [352]	9 11/16" [246]	*TDT3 2204	*TDT3 2404	*TDT3 2704	*TDT3 3004	*TDT3 3004
	24 3/16" [615]	23 5/8" [600]	21 3/4" [552]	17 9/16" [446]	*TDT3 2206	*TDT3 2406	*TDT3 2706	*TDT3 3006	*TDT3 3006
	32 1/4" [819]	31 1/2" [800]	29 9/16" [751]	25 3/8" [645]	*TDT3 2208	*TDT3 2408	*TDT3 2708	*TDT3 3008	*TDT3 3008
					DOORS				
	80 1/8" [2035]	79 1/2" [2020]	77" [1956]	69 3/4" [1771]	TD3 2220	TD3 2420	TD3 2720	TD3 3020	TD3 3220
	81 7/8" [2080]	81 5/16" [2065]	78 3/4" [2001]	71 1/2" [1816]	TD3 2221	TD3 2421	TD3 2721	TD3 3021	TD3 3221
	86 9/16" [2199]	86" [2184]	83 7/16" [2120]	76 3/16" [1935]	TD3 2270	TD3 2470	TD3 2770	TD3 3070	TD3 3270
	95 1/16" [2415]	94 1/2" [2400]	91 15/16" [2336]	84 11/16" [2151]	TD3 2224	TD3 2424	TD3 2724	TD3 3024	TD3 3224
	98" [2489]	97 3/8" [2474]	94 7/8" [2410]	87 5/8" [2225]	TD3 2280	TD3 2480	TD3 2780	TD3 3080	TD3 3280
	99 5/8" [2531]	99 1/16" [2516]	96 9/16" [2452]	89 1/4" [2267]	TD3 2225	TD3 2425	TD3 2725	TD3 3025	TD3 3225
	106 7/8" [2715]	106 5/16" [2700]	103 3/4" [2636]	96 1/2" [2451]	TD3 2227	TD3 2427	TD3 2727	TD3 3027	TD3 3227

* Transom

Swinging Terrace & French Doors -
2.25 Inch - **Narrow Stile (3") TD**

Size Charts

TD4 Metal-Clad

Rough Opening				Width				
				Frame				
				Panel				
				Visible Glass				
				117" [2972]	130 1/16" [3304]	140 5/8" [3572]	156 3/8" [3972]	170 11/16" [4336]
				116 1/4" [2953]	129 5/16" [3285]	139 7/8" [3553]	155 5/8" [3953]	169 15/16" [4317]
				28 1/2" [723]	31 3/4" [806]	34 3/8" [873]	38 5/16" [973]	41 7/8" [1064]
				22 9/16" [573]	25 13/16" [656]	28 1/2" [723]	32 7/16" [823]	36" [914]
				TRANSOM				
16 1/2" [419]	15 3/4" [400]	13 7/8" [352]	9 11/16" [246]	*TDT4 3004	*TDT4 3204	*TDT4 3604	*TDT4 4004	*TDT4 4004
24 3/8" [619]	23 5/8" [600]	21 3/4" [552]	17 9/16" [446]	*TDT4 3006	*TDT4 3206	*TDT4 3606	*TDT4 4006	*TDT4 4006
32 1/4" [819]	31 1/2" [800]	29 5/8" [752]	25 7/16" [646]	*TDT4 3006	*TDT4 3206	*TDT4 3606	*TDT4 4006	*TDT4 4006
				DOORS				
80 1/8" [2035]	79 1/2" [2020]	76 7/16" [1942]	68 13/16" [1748]	TD4 3020	TD4 3220	TD4 3620	TD4 4020	TD4 4320
81 7/8" [2080]	81 5/16" [2065]	78 1/4" [1987]	70 9/16" [1793]	TD4 3021	TD4 3221	TD4 3621	TD4 4021	TD4 4321
86 9/16" [2199]	86" [2184]	82 15/16" [2106]	75 1/4" [1912]	TD4 3070	TD4 3270	TD4 3670	TD4 4070	TD4 4370
95 1/16" [2415]	94 1/2" [2400]	91 7/16" [2322]	83 3/4" [2128]	TD4 3024	TD4 3224	TD4 3624	TD4 4024	TD4 4324
98" [2489]	97 3/8" [2474]	94 5/16" [2396]	86 11/16" [2202]	TD4 3080	TD4 3280	TD4 3680	TD4 4080	TD4 4380
99 5/8" [2531]	99 1/16" [2516]	96" [2438]	88 3/8" [2244]	TD4 3025	TD4 3225	TD4 3625	TD4 4025	TD4 4325
106 7/8" [2715]	106 5/16" [2700]	103 1/4" [2622]	95 9/16" [2428]	TD4 3027	TD4 3227	TD4 3627	TD4 4027	TD4 4327

* Transom

Swinging Terrace & French Doors -
2.25 Inch - **Narrow Stile (3") TD**

Size Charts

TD4 Non-Clad

←————— **Width** —————→

Rough Opening				117"	130 1/16"	140 5/8"	156 3/8"	170 11/16"					
				Frame					116 1/4"	129 5/16"	139 7/8"	155 5/8"	169 15/16"
				Panel				28 1/2"	31 3/4"	34 3/8"	38 5/16"	41 7/8"	
				Visible Glass			22 9/16"	25 13/16"	28 1/2"	32 7/16"	36"		
				TRANSOM									
16 5/16"	15 3/4"	13 7/8"	9 11/16"	*TDT4 3004	*TDT4 3204	*TDT4 3604	*TDT4 4004	*TDT4 4004					
24 3/16"	23 5/8"	21 3/4"	17 9/16"	*TDT4 3006	*TDT4 3206	*TDT4 3606	*TDT4 4006	*TDT4 4006					
32 1/4"	31 1/2"	29 9/16"	25 3/8"	*TDT4 3008	*TDT4 3208	*TDT4 3608	*TDT4 4008	*TDT4 4008					
				DOORS									
80 1/8"	79 1/2"	77"	69 3/4"	TD4 3020	TD4 3220	TD4 3620	TD4 4020	TD4 4320					
81 7/8"	81 5/16"	78 3/4"	71 1/2"	TD4 3021	TD4 3221	TD4 3621	TD4 4021	TD4 4321					
86 9/16"	86"	83 7/16"	76 3/16"	TD4 3070	TD4 3270	TD4 3670	TD4 4070	TD4 4370					
95 1/16"	94 1/2"	91 15/16"	84 11/16"	TD4 3024	TD4 3224	TD4 3624	TD4 4024	TD4 4324					
98"	97 3/8"	94 7/8"	87 5/8"	TD4 3080	TD4 3280	TD4 3680	TD4 4080	TD4 4380					
99 5/8"	99 1/16"	96 9/16"	89 1/4"	TD4 3025	TD4 3225	TD4 3625	TD4 4025	TD4 4325					
106 7/8"	106 5/16"	103 3/4"	96 1/2"	TD4 3027	TD4 3227	TD4 3627	TD4 4027	TD4 4327					

↑————— **Height** —————↓

* Transom

Swinging Terrace & French Doors -
2.25 Inch - **Narrow Stile (3") TD**

Drawings

Outswing

HEAD & SILL DETAILS

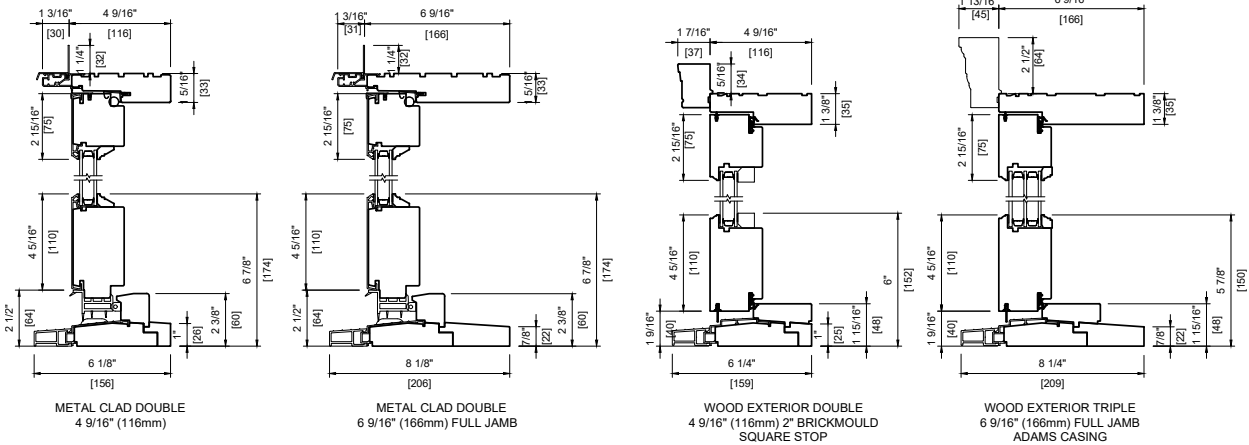

HEAD & SILL DETAILS

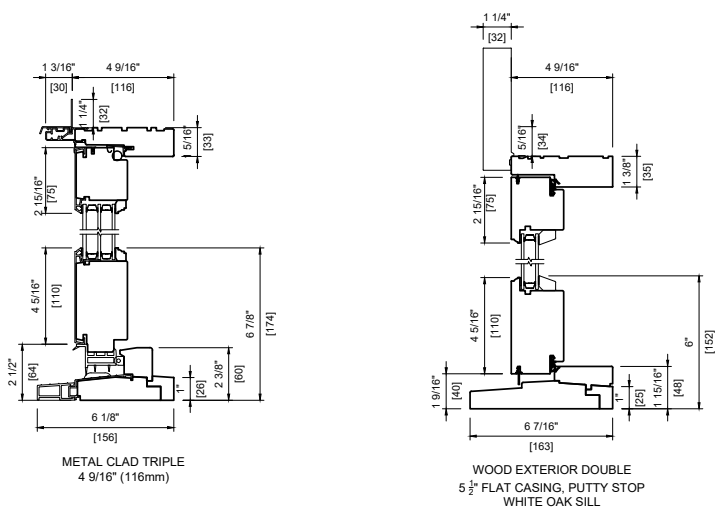

GLAZING STOP PROFILES

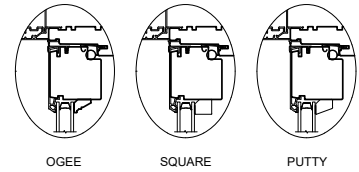

CASING

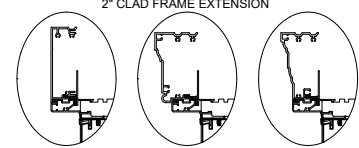
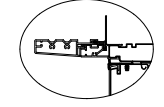
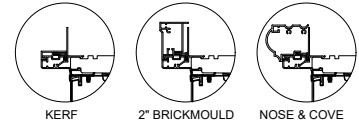

SEE PAGE A22 FOR DIMENSIONS.

Swinging Terrace & French Doors -
2.25 Inch - **Narrow Stile (3") TD**

Drawings

Outswing (cont'd)

PLAN VIEW

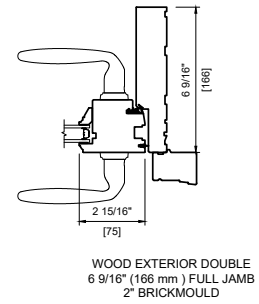
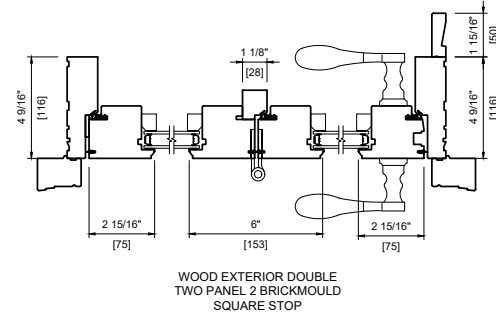
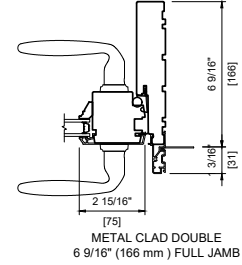
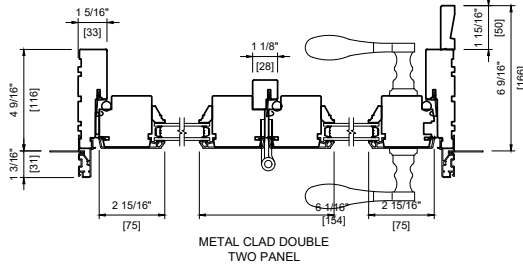

PLAN VIEW

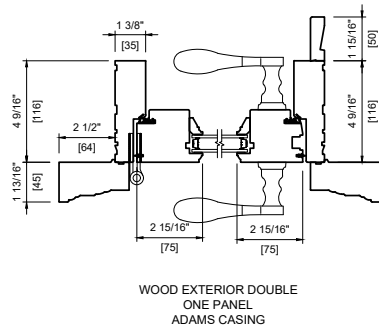
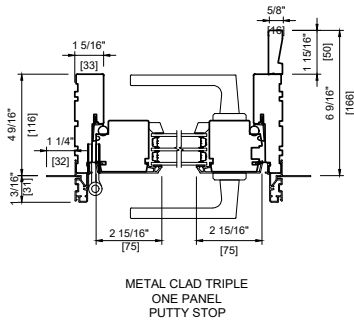

GLAZING STOP PROFILES

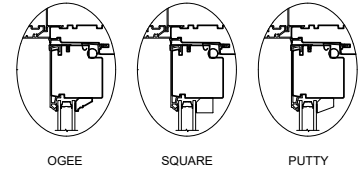

CASING

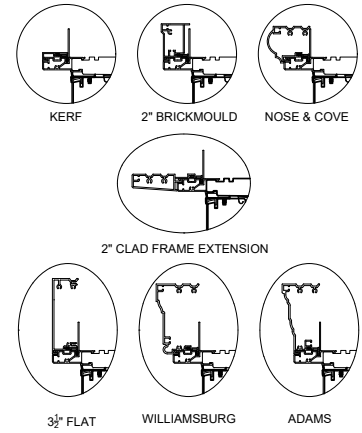

Swinging Terrace & French Doors -
2.25 Inch - **Narrow Stile (3") TD**

Drawings

3 & 4 Wide Outswing

PLAN VIEW

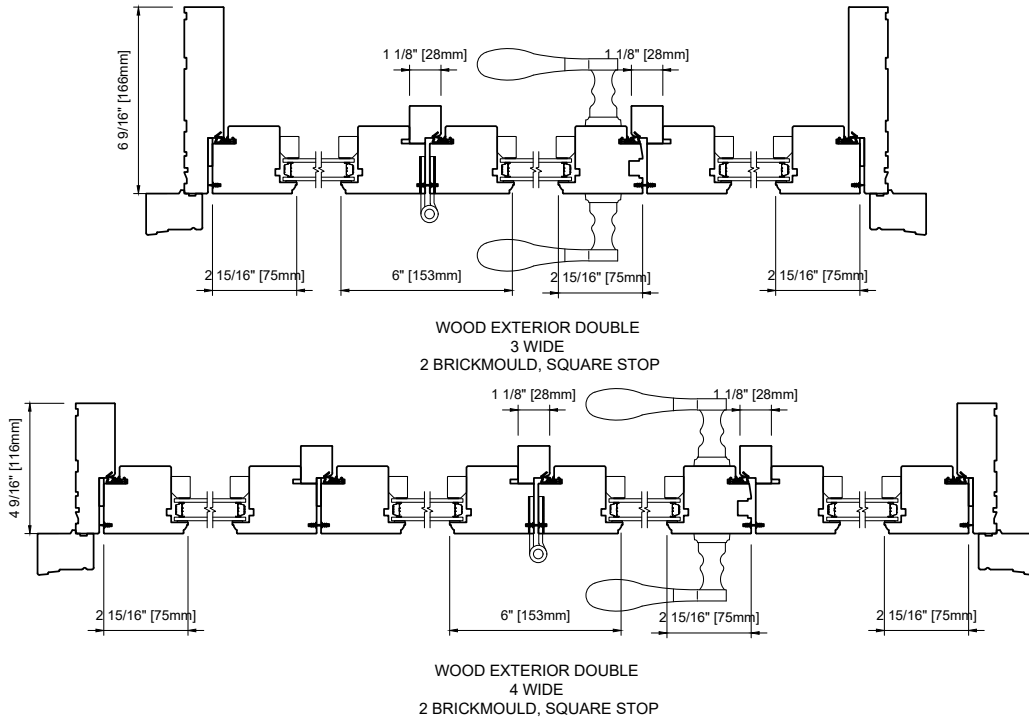
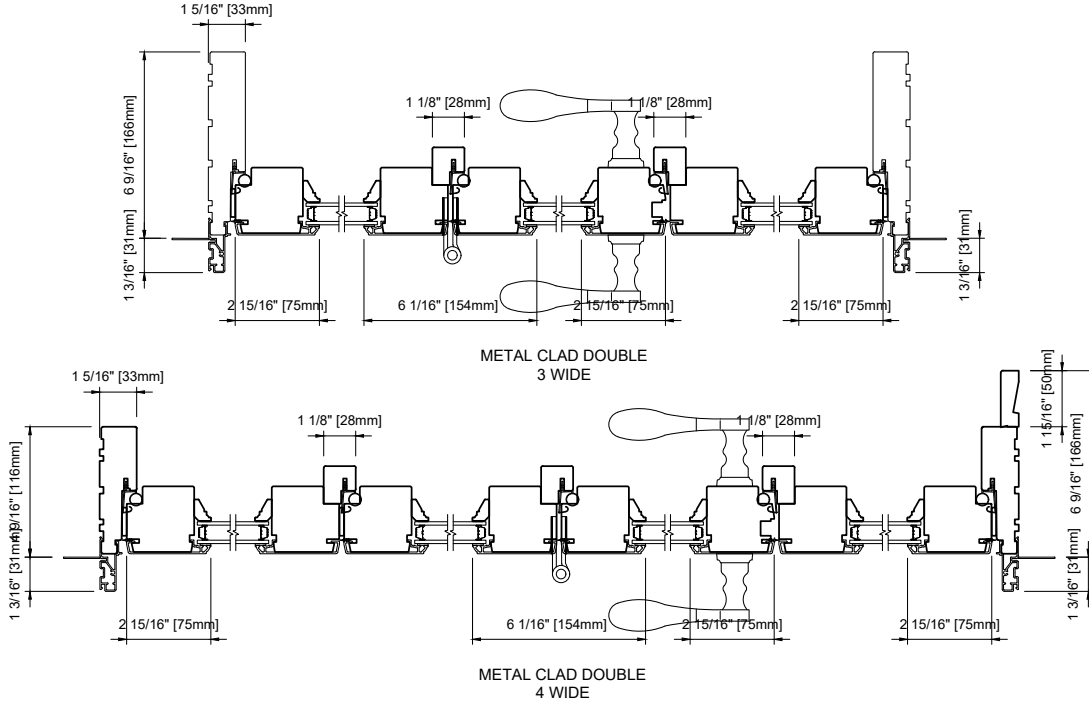

Swinging Terrace & French Doors -
2.25 Inch - **Narrow Stile (3") TD**

Drawings

Outswing Transom

HEAD & SILL

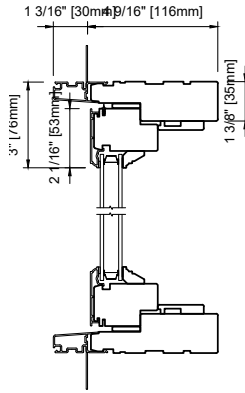

METAL CLAD DOUBLE
2 1/16" (53mm) RAILS

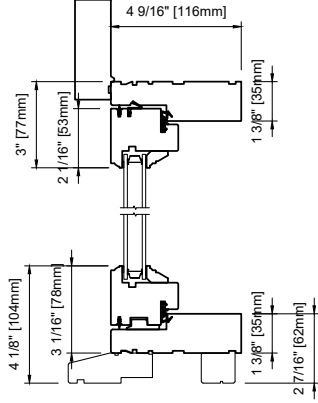

WOOD EXTERIOR DOUBLE
2 1/16" (53mm) RAILS

PLAN VIEW

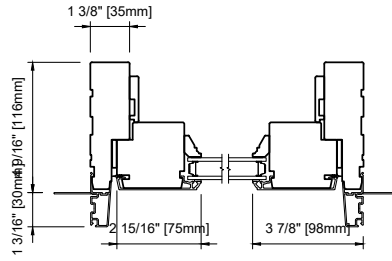

METAL CLAD DOUBLE
2 15/16" (75mm) STILES

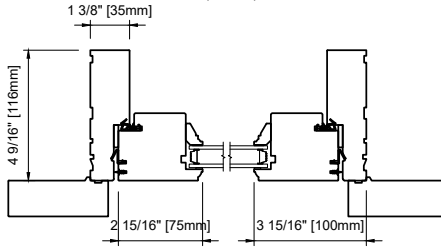

WOOD EXTERIOR DOUBLE
2 15/16" (75mm) STILES

PLAN VIEW

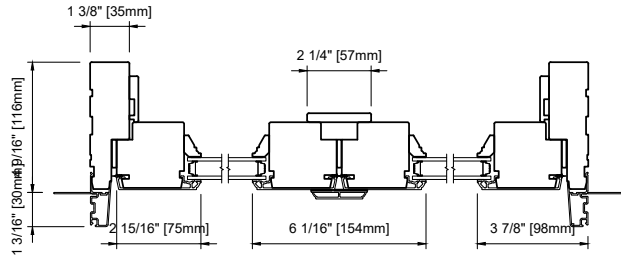

METAL CLAD DOUBLE
2 15/16" (75mm) STILES
2 - PANEL

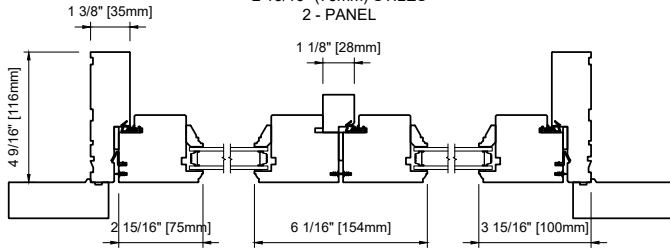

WOOD EXTERIOR DOUBLE
2 15/16" (75mm) STILES
2 - PANEL

Swinging Terrace & French Doors -
2.25 Inch - **Standard Stile (>3") TD**

Size Charts

TD1 Metal-Clad

Width

Height

Rough Opening				Width									
				Frame			18 7/16" [469]	24 3/8" [619]	31 1/4" [793]	34 1/2" [876]	37 1/8" [943]	41 1/16" [1043]	44 5/8" [1134]
				Panel		Visible Glass	15 13/16" [402]	21 3/4" [552]	28 9/16" [726]	31 7/8" [809]	34 1/2" [876]	38 7/16" [976]	42" [1065]
							7 3/16" [182]	13 1/16" [332]	19 15/16" [506]	23 3/16 " [589]	25 13/16" [656]	29 3/4" [756]	33 3/8" [847]
				TRANSOM									
16 1/2" [419]	15 3/4" [400]	13 7/8" [352]	9 11/16" [246]	*TDT1 0404	*TDT1 0604	*TDT1 0704	*TDT1 0804	*TDT1 0904	*TDT1 1004	*TDT1 1104			
24 3/8" [619]	23 5/8" [600]	21 3/4" [552]	17 9/16" [446]	*TDT1 0406	*TDT1 0606	*TDT1 0706	*TDT1 0806	*TDT1 0906	*TDT1 1006	*TDT1 1106			
32 1/4" [819]	31 1/2" [800]	29 5/8" [752]	25 7/16" [646]	*TDT1 0408	*TDT1 0608	*TDT1 0708	*TDT1 0808	*TDT1 0908	*TDT1 1008	*TDT1 1108			
				FIXED SIDELITES			DOORS						
80 1/8" [2035]	79 1/2" [2020]	76 7/16" [1942]	63 7/8" [1623]	^TD1 0420	^TD1 0620	TD1 0720	TD1 0820	TD1 0920	TD1 1020	TD1 1120			
81 7/8" [2080]	81 5/16" [2065]	78 1/4" [1987]	65 11/16" [1668]	^TD1 0421	^TD1 0621	TD1 0721	TD1 0821	TD1 0921	TD1 1021	TD1 1121			
86 9/16" [2199]	86" [2184]	82 15/16" [2106]	70 3/8" [1787]	^TD1 0470	^TD1 0670	TD1 0770	TD1 0870	TD1 0970	TD1 1070	TD1 1170			
95 1/16" [2415]	94 1/2" [2400]	91 7/16" [2322]	78 7/8" [2003]		^TD1 0624	TD1 0724	TD1 0824	TD1 0924	TD1 1024	TD1 1124			
98" [2489]	97 3/8" [2474]	94 5/16" [2396]	81 3/4" [2077]		^TD1 0680	TD1 0780	TD1 0880	TD1 0980	TD1 1080	TD1 1180			
99 5/8" [2531]	99 1/16" [2516]	96" [2438]	83 7/16" [2119]		^TD1 0625	TD1 0725	TD1 0825	TD1 0925	TD1 1025	TD1 1125			
106 7/8" [2715]	106 5/16" [2700]	103 1/4" [2622]	90 11/16" [2303]		^TD1 0627	TD1 0727	TD1 0827	TD1 0927	TD1 1027	TD1 1127			
124" [3150]	123 7/16" [3135]	120 3/8" [3057]	107 13/16" [2738]		^TD1 0632	TD1 0732	TD1 0832	TD1 0932	TD1 1032	TD1 1132			

* Transom
^ Fixed

Swinging Terrace & French Doors -
2.25 Inch - **Standard Stile (>3") TD**

Size Charts

TD1 Non-Clad

Width

Height

Rough Opening				18 7/16" [469]	24 3/8" [619]	31 1/4" [793]	34 1/2" [876]	38 11/16" [983]	41 1/16" [1043]	44 5/8" [1134]				
				Frame				17 11/16" [450]	23 5/8" [600]	30 1/2" [774]	33 3/4" [857]	37 15/16" [964]	40 5/16" [1024]	43 7/8" [1115]
				Panel				15 3/4" [400]	21 5/8" [550]	28 1/2" [724]	31 3/4" [807]	36" [914]	38 3/8" [974]	41 15/16" [1065]
				Visible Glass				7 1/16" [180]	13" [330]	19 13/16" [504]	23 1/8" [587]	27 5/16" [694]	29 11/16" [754]	33 1/4" [845]
				TRANSOM										
16 1/2" [419]	15 3/4" [400]	13 13/16" [351]	9 5/8" [245]	*TDT1 0404	*TDT1 0604	*TDT1 0704	*TDT1 0804	*TDT1 0904	*TDT1 1004	*TDT1 1104				
24 3/8" [619]	23 5/8" [600]	21 11/16" [551]	17 1/2" [445]	*TDT1 0406	*TDT1 0606	*TDT1 0706	*TDT1 0806	*TDT1 0906	*TDT1 1006	*TDT1 1106				
32 1/4" [819]	31 1/2" [800]	29 9/16" [751]	25 3/8" [645]	*TDT1 0408	*TDT1 0608	*TDT1 0708	*TDT1 0808	*TDT1 0908	*TDT1 1008	*TDT1 1108				
				VENTING SIDELITES			DOORS							
80 1/8" [2035]	79 1/2" [2020]	77" [1956]	64 13/16" [1646]	^TD1 0420	^TD1 0620	TD1 0720	TD1 0820	TD1 0920	TD1 1020	TD1 1120				
81 7/8" [2080]	81 5/16" [2065]	78 3/4" [2001]	66 9/16" [1691]	^TD1 0421	^TD1 0621	TD1 0721	TD1 0821	TD1 0921	TD1 1021	TD1 1121				
86 9/16" [2199]	86" [2184]	83 7/16" [2120]	71 4/4" [1810]	^TD1 0470	^TD1 0670	TD1 0770	TD1 0870	TD1 0970	TD1 1070	TD1 1170				
95 1/16" [2415]	94 1/2" [2400]	91 15/16" [2336]	79 3/4" [2026]	/	^TD1 0624	TD1 0724	TD1 0824	TD1 0924	TD1 1024	TD1 1124				
98" [2489]	97 3/8 " [2474]	94 5/8" [2410]	82 11/16" [2100]	/	^TD1 0680	TD1 0780	TD1 0880	TD1 0980	TD1 1080	TD1 1180				
99 5/8" [2531]	99 1/16" [2516]	96 9/16" [2452]	84 5/16" [2142]	/	^TD1 0625	TD1 0725	TD1 0825	TD1 0925	TD1 1025	TD1 1125				
106 7/8" [2715]	106 5/16" [2700]	103 3/4" [2636]	91 9/16" [2326]	/	^TD1 0627	TD1 0727	TD1 0827	TD1 0927	TD1 1027	TD1 1127				
124" [3150]	123 7/16" [3135]	120 7/8" [3071]	108 11/16" [2761]	/	^TD1 0632	TD1 0732	TD1 0832	TD1 0932	TD1 1032	TD1 1132				

* Transom
^ Fixed

Swinging Terrace & French Doors -
2.25 Inch - **Standard Stile (>3") TD**

Size Charts

TD2 Metal-Clad

Width

Height

Rough Opening				Width					
				Frame					
				Panel					
				Visible Glass					
				46 1/8" [1171]	59 13/16" [1519]	66 5/16" [1685]	71 5/8" [1819]	79 1/2" [2019]	86 5/8" [2201]
				45 3/8" [1152]	59 1/16" [1500]	65 9/16" [1666]	70 7/8" [1800]	78 3/4" [2000]	85 7/8" [2182]
				21 5/8" [550]	28 1/2" [724]	31 3/4" [807]	34 7/16" [874]	38 3/8" [974]	41 15/16" [1065]
				13" [330]	19 13/16" [504]	23 1/8" [587]	25 3/4" [654]	29 11/16" [754]	33 1/4" [845]
				TRANSOM					
16 1/2" [419]	15 3/4" [400]	13 7/8" [352]	9 11/16" [246]	*TDT2 1204	*TDT2 1504	*TDT2 1604	*TDT2 1804	*TDT2 2004	*TDT2 2204
24 3/8" [619]	23 5/8" [600]	21 3/4" [552]	17 9/16" [446]	*TDT2 1206	*TDT2 1506	*TDT2 1606	*TDT2 1806	*TDT2 2006	*TDT2 2206
32 1/4" [819]	31 1/2" [800]	29 5/8" [752]	25 7/16" [646]	*TDT2 1208	*TDT2 1508	*TDT2 1608	*TDT2 1808	*TDT2 2008	*TDT2 2208
				DOORS					
80 1/8" [2035]	79 1/2" [2020]	76 7/16" [1942]	63 7/8" [1623]	TD2 1220	TD2 1520	TD2 1620	TD2 1820	TD2 2020	TD2 2220
81 7/8" [2080]	81 5/16" [2065]	78 1/4" [1987]	65 11/16" [1668]	TD2 1221	TD2 1521	TD2 1621	TD2 1821	TD2 2021	TD2 2221
86 9/16" [2199]	86" [2184]	82 15/16" [2106]	70 3/8" [1787]	TD2 1270	TD2 1570	TD2 1670	TD2 1870	TD2 2070	TD2 2270
95 1/16" [2415]	94 1/2" [2400]	91 7/16" [2322]	78 7/8" [2003]	TD2 1224	TD2 1524	TD2 1624	TD2 1824	TD2 2024	TD2 2224
98" [2489]	97 3/8" [2474]	94 5/16" [2396]	81 3/4" [2077]	TD2 1280	TD2 1580	TD2 1680	TD2 1880	TD2 2080	TD2 2280
99 5/8" [2531]	99 1/16" [2516]	96" [2438]	83 7/16" [2119]	TD2 1225	TD2 1525	TD2 1625	TD2 1825	TD2 2025	TD2 2225
106 7/8" [2715]	106 5/16" [2700]	103 1/4" [2622]	90 11/16" [2303]	TD2 1227	TD2 1527	TD2 1627	TD2 1827	TD2 2027	TD2 2227
124" [3150]	123 7/16" [3135]	120 3/8" [3057]	107 13/16" [2738]	TD2 1232	TD2 1532	TD2 1632	TD2 1832	TD2 2032	TD2 2232

* Transom

Swinging Terrace & French Doors -
2.25 Inch - **Standard Stile (>3") TD**

Size Charts

TD2 Non-Clad

Width

Height

Rough Opening				Width							
				Frame		46 1/8" [1171]	59 13/16" [1519]	66 5/16" [1685]	74 3/4" [1899]	79 1/2" [2019]	86 5/8" [2201]
				Panel		45 3/8" [1152]	59 1/16" [1500]	65 9/16" [1666]	74 1/16" [1882]	78 3/4" [2000]	85 7/8" [2182]
				Visible Glass		21 5/8" [549]	28 7/16" [723]	31 3/4" [806]	35 15/16" [913]	38 5/16" [973]	41 7/8" [1064]
				12 15/16" [329]	19 13/16" [503]	23 1/16" [586]	27 5/16" [693]	29 5/8" [753]	33 1/4" [844]		
				TRANSOM							
16 1/2" [419]	15 3/4" [400]	13 13/16" [351]	9 5/8" [245]	*TDT2 1204	*TDT2 1504	*TDT2 1604	*TDT2 1804	*TDT2 2004	*TDT2 2204		
24 3/8" [619]	23 5/8" [600]	21 11/16" [551]	17 1/2" [445]	*TDT2 1206	*TDT2 1506	*TDT2 1606	*TDT2 1806	*TDT2 2006	*TDT2 2206		
32 1/4" [819]	31 1/2" [800]	29 9/16" [751]	25 3/8" [645]	*TDT2 1208	*TDT2 1508	*TDT2 1608	*TDT2 1808	*TDT2 2008	*TDT2 2208		
				DOORS							
80 1/8" [2035]	79 1/2" [2020]	77" [1956]	64 13/16" [1646]	TD2 1220	TD2 1520	TD2 1620	TD2 1820	TD2 2020	TD2 2220		
81 7/8" [2080]	81 5/16" [2065]	78 3/4" [2001]	66 9/16" [1691]	TD2 1221	TD2 1521	TD2 1621	TD2 1821	TD2 2021	TD2 2221		
86 9/16" [2199]	86" [2184]	83 7/16" [2120]	71 4/4" [1810]	TD2 1270	TD2 1570	TD2 1670	TD2 1870	TD2 2070	TD2 2270		
95 1/16" [2415]	94 1/2" [2400]	91 15/16" [2336]	79 3/4" [2026]	TD2 1224	TD2 1524	TD2 1624	TD2 1824	TD2 2024	TD2 2224		
98" [2489]	97 3/8" [2474]	94 57/8" [2410]	82 11/16" [2100]	TD2 1280	TD2 1580	TD2 1680	TD2 1880	TD2 2080	TD2 2280		
99 5/8" [2531]	99 1/16" [2516]	96 9/16" [2452]	84 5/16" [2142]	TD2 1225	TD2 1525	TD2 1625	TD2 1825	TD2 2025	TD2 2225		
106 7/8" [2715]	106 5/16" [2700]	103 3/4" [2636]	91 9/16" [2326]	TD2 1227	TD2 1527	TD2 1627	TD2 1827	TD2 2027	TD2 2227		
124" [3150]	123 7/16" [3135]	120 7/8" [3071]	108 11/16" [2761]	TD2 1232	TD2 1532	TD2 1632	TD2 1832	TD2 2032	TD2 2232		

* Transom

Swinging Terrace & French Doors -
2.25 Inch - **Standard Stile (>3") TD**

Size Charts

TD3 Metal-Clad

Width

Height

Rough Opening				88 3/8"	98 3/16"	106 1/8"	117 15/16"	128 11/16"				
				Frame				87 5/8"	97 7/16"	105 3/8"	117 3/16"	127 15/16"
				Panel				28 1/2"	31 3/4"	34 3/8"	38 5/16"	41 7/8"
				Visible Glass				19 13/16"	23 1/16"	25 3/4"	29 11/16"	33 1/4"
				TRANSOM								
16 1/2"	15 3/4"	13 7/8"	9 11/16"	*TDT3 2204	*TDT3 2404	*TDT3 2704	*TDT3 3004	*TDT3 3204				
24 3/8"	23 5/8"	21 3/4"	17 9/16"	*TDT3 2206	*TDT3 2406	*TDT3 2706	*TDT3 3006	*TDT3 3206				
32 1/4"	31 1/2"	29 5/8"	25 7/16"	*TDT3 2208	*TDT3 2408	*TDT3 2708	*TDT3 3008	*TDT3 3208				
				DOORS								
80 1/8"	79 1/2"	76 7/16"	63 7/8"	TD3 2220	TD3 2420	TD3 2720	TD3 3020	TD3 3220				
81 7/8"	81 5/16"	78 1/4"	65 11/16"	TD3 2221	TD3 2421	TD3 2721	TD3 3021	TD3 3221				
86 9/16"	86"	82 15/16"	70 3/8"	TD3 2270	TD3 2470	TD3 2770	TD3 3070	TD3 3270				
95 1/16"	94 1/2"	91 7/16"	78 7/8"	TD3 2224	TD3 2424	TD3 2724	TD3 3024	TD3 3224				
98"	97 3/8"	94 5/16"	81 3/4"	TD3 2280	TD3 2480	TD3 2780	TD3 3080	TD3 3280				
99 5/8"	99 1/16"	96"	83 7/16"	TD3 2225	TD3 2425	TD3 2725	TD3 3025	TD3 3225				
106 7/8"	106 5/16"	103 1/4"	90 11/16"	TD3 2227	TD3 2427	TD3 2727	TD3 3027	TD3 3227				
124"	123 7/16"	120 3/8"	107 13/16"	TD3 2232	TD3 2432	TD3 2732	TD3 3032	TD3 3232				

* Transom

Swinging Terrace & French Doors -
2.25 Inch - **Standard Stile (>3") TD**

Size Charts

TD3 Non-Clad

Width

Height

Rough Opening				88 3/8" [2245]	98 3/16" [2494]	111" [2219]	117 15/16" [2995]	128 11/16" [3268]				
				Frame				87 5/8" [2226]	97 7/16" [2475]	110 1/4" [2800]	117 3/16" [2976]	127 15/16" [3249]
				Panel				28 7/16" [723]	31 3/4" [806]	36" [914]	38 5/16 " [973]	41 7/8" [1064]
				Visible Glass				19 13/16" [503]	23 1/16" [586]	27 5/16" [694]	29 5/8" [753]	33 3/16" [844]
				TRANSOM								
16 5/16" [415]	15 3/4" [400]	13 7/8" [352]	9 11/16" [246]	*TDT3 2204	*TDT3 2404	*TDT3 2704	*TDT3 3004	*TDT3 3204				
24 3/16" [615]	23 5/8" [600]	21 3/4" [552]	17 9/16" [446]	*TDT3 2206	*TDT3 2406	*TDT3 2706	*TDT3 3006	*TDT3 3206				
32 1/4" [819]	31 1/2" [800]	29 9/16" [751]	25 3/8" [645]	*TDT3 2208	*TDT3 2408	*TDT3 2708	*TDT3 3008	*TDT3 3208				
				DOORS								
80 1/8" [2035]	79 1/2" [2020]	77" [1956]	64 13/16" [1646]	TD3 2220	TD3 2420	TD3 2720	TD3 3020	TD3 3220				
81 7/8" [2080]	81 5/16" [2065]	78 3/4" [2001]	66 9/16" [1691]	TD3 2221	TD3 2421	TD3 2721	TD3 3021	TD3 3221				
86 9/16" [2199]	86" [2184]	83 7/16" [2120]	71 4/4" [1810]	TD3 2270	TD3 2470	TD3 2770	TD3 3070	TD3 3270				
95 1/16" [2415]	94 1/2" [2400]	91 15/16" [2336]	79 3/4" [2026]	TD3 2224	TD3 2424	TD3 2724	TD3 3024	TD3 3224				
98" [2489]	97 3/8" [2474]	94 57/8" [2410]	82 11/16" [2100]	TD3 2280	TD3 2480	TD3 2780	TD3 3080	TD3 3280				
99 5/8" [2531]	99 1/16" [2516]	96 9/16" [2452]	84 5/16" [2142]	TD3 2225	TD3 2425	TD3 2725	TD3 3025	TD3 3225				
106 7/8" [2715]	106 5/16" [2700]	103 3/4" [2636]	91 9/16" [2326]	TD3 2227	TD3 2427	TD3 2727	TD3 3027	TD3 3227				
124" [3150]	123 7/16" [3135]	120 7/8" [3071]	108 11/16" [2761]	TD3 2232	TD3 2432	TD3 2732	TD3 3032	TD3 3232				

* Transom

Swinging Terrace & French Doors -
2.25 Inch - **Standard Stile (>3") TD**

Size Charts

TD4 Metal-Clad

Width

Height

Rough Opening				117"	130 1/16"	140 5/8"	156 3/8"	170 11/16"				
				Frame				116 1/4"	129 5/16"	139 7/8"	155 5/8"	169 15/16"
				Panel				28 1/2"	31 3/4"	34 3/8"	38 5/16"	41 7/8"
				Visible Glass				19 13/16"	23 1/16"	25 3/4"	29 11/16"	33 1/4"
				TRANSOM								
16 1/2" [419]	15 3/4" [400]	13 7/8" [352]	9 11/16" [246]	*TDT4 3004	*TDT4 3204	*TDT4 3604	*TDT4 4004	*TDT4 4304				
24 3/8" [619]	23 5/8" [600]	21 3/4" [552]	17 9/16" [446]	*TDT4 3006	*TDT4 3206	*TDT4 3606	*TDT4 4006	*TDT4 4306				
32 1/4" [819]	31 1/2" [800]	29 5/8" [752]	25 7/16" [646]	*TDT4 3008	*TDT4 3208	*TDT4 3608	*TDT4 4008	*TDT4 4308				
				DOORS								
80 1/8" [2035]	79 1/2" [2020]	76 7/16" [1942]	63 7/8" [1623]	TD4 3020	TD4 3220	TD4 3620	TD4 4020	TD4 4320				
81 7/8" [2080]	81 5/16" [2065]	78 1/4" [1987]	65 11/16" [1668]	TD4 3021	TD4 3221	TD4 3621	TD4 4021	TD4 4321				
86 9/16" [2199]	86" [2184]	82 15/16" [2106]	70 3/8" [1787]	TD4 3070	TD4 3270	TD4 3670	TD4 4070	TD4 4370				
95 1/16" [2415]	94 1/2" [2400]	91 7/16" [2322]	78 7/8" [2003]	TD4 3024	TD4 3224	TD4 3624	TD4 4024	TD4 4324				
98" [2489]	97 3/8" [2474]	94 5/16" [2396]	81 3/4" [2077]	TD4 3080	TD4 3280	TD4 3680	TD4 4080	TD4 4380				
99 5/8" [2531]	99 1/16" [2516]	96" [2438]	83 7/16" [2119]	TD4 3025	TD4 3225	TD4 3625	TD4 4025	TD4 4325				
106 7/8" [2715]	106 5/16" [2700]	103 1/4" [2622]	90 11/16" [2303]	TD4 3027	TD4 3227	TD4 3627	TD4 4027	TD4 4327				
124" [3150]	123 7/16" [3135]	120 3/8" [3057]	107 13/16" [2738]	TD4 3032	TD4 3032	TD4 3632	TD4 4032	TD4 4332				

* Transom

Swinging Terrace & French Doors -
2.25 Inch - **Standard Stile (>3") TD**

Size Charts

TD4 Non-Clad

Width

Rough Opening				117" [2972]	130 1/16" [3304]	147 1/8" [3737]	156 3/8" [3972]	170 11/16" [4336]				
				Frame				116 1/4" [2953]	129 5/16" [3285]	146 3/8" [3718]	155 5/8" [3953]	169 15/16" [4317]
				Panel				287/16" [723]	31 3/4" [806]	36" [914]	38 5/16" [973]	41 7/8" [1064]
				Visible Glass				19 13/16" [503]	23 1/16" [586]	27 5/16" [694]	29 5/8" [753]	33 3/16" [844]
				TRANSOM								
16 5/16" [415]	15 3/4" [400]	13 7/8" [352]	9 11/16" [246]	*TDT4 3004	*TDT4 3204	*TDT4 3604	*TDT4 4004	*TDT4 4304				
24 3/16" [615]	23 5/8" [600]	21 3/4" [552]	17 9/16" [446]	*TDT4 3006	*TDT4 3206	*TDT4 3606	*TDT4 4006	*TDT4 4306				
32 1/4" [819]	31 1/2" [800]	29 9/16" [751]	25 3/8" [645]	*TDT4 3008	*TDT4 3208	*TDT4 3608	*TDT4 4008	*TDT4 4308				
				DOORS								
80 1/8" [2035]	79 1/2" [2020]	77" [1956]	64 13/16" [1646]	TD4 3020	TD4 3220	TD4 3620	TD4 4020	TD4 4320				
81 7/8" [2080]	81 5/16" [2065]	78 3/4" [2001]	66 9/16" [1691]	TD4 3021	TD4 3221	TD4 3621	TD4 4021	TD4 4321				
86 9/16" [2199]	86" [2184]	83 7/16" [2120]	71 4/4" [1810]	TD4 3070	TD4 3270	TD4 3670	TD4 4070	TD4 4370				
95 1/16" [2415]	94 1/2" [2400]	91 15/16" [2336]	79 3/4" [2026]	TD4 3024	TD4 3224	TD4 3624	TD4 4024	TD4 4324				
98" [2489]	97 3/8" [2474]	94 5/8" [2410]	82 11/16" [2100]	TD4 3080	TD4 3280	TD4 3680	TD4 4080	TD4 4380				
99 5/8" [2531]	99 1/16" [2516]	96 9/16" [2452]	84 5/16" [2142]	TD4 3025	TD4 3225	TD4 3625	TD4 4025	TD4 4325				
106 7/8" [2715]	106 5/16" [2700]	103 3/4" [2636]	91 9/16" [2326]	TD4 3027	TD4 3227	TD4 3627	TD4 4027	TD4 4327				
124" [3150]	123 7/16" [3135]	120 7/8" [3071]	108 11/16" [2761]	TD4 3032	TD4 3032	TD4 3632	TD4 4032	TD4 4332				

Height

* Transom

Swinging Terrace & French Doors -
2.25 Inch - **Standard Stile (>3") TD**

Size Charts

Cambertop TD1 Metal-Clad

				Width					
Height	Rough Opening	Frame		31 1/4" [793]	34 1/2" [876]	37 1/8" [943]	41 1/16" [1043]	44 5/8" [1134]	
		Panel	30 1/2" [774]	33 3/4" [857]	36 3/8" [924]	40 5/16" [1024]	43 7/8" [1115]		
			Visible Glass	28 9/16" [726]	31 7/8" [809]	34 1/2" [876]	38 7/16" [976]	42" [1067]	
				19 15/16" [506]	23 3/16" [589]	25 13/16" [656]	29 3/4" [756]	33 3/8" [847]	
	80 1/8" [2035]	79 1/2" [2020]	76 3/8" [1940]	63 15/16" [1624]	CTTD1 0720	CTTD1 0820	CTTD1 0920	CTTD1 1020	CTTD1 1120
	81 7/8" [2080]	81 5/16" [2065]	78 3/16" [1985]	65 11/16" [1669]	CTTD1 0721	CTTD1 0821	CTTD1 0921	CTTD1 1021	CTTD1 1121
	86 9/16" [2199]	86" [2184]	82 7/8" [2104]	70 3/8" [1788]	CTTD1 0770	CTTD1 0870	CTTD1 0970	CTTD1 1070	CTTD1 1170
	95 1/16" [2415]	94 1/2" [2400]	91 3/8" [2320]	78 7/8" [2004]	CTTD1 0724	CTTD1 0824	CTTD1 0924	CTTD1 1024	CTTD1 1124
	98" [2489]	97 3/8" [2474]	94 1/4" [2394]	81 13/16" [2078]	CTTD1 0780	CTTD1 0880	CTTD1 0980	CTTD1 1080	CTTD1 1180
	99 5/8" [2531]	99 1/16" [2516]	95 15/16" [2436]	83 7/16" [2120]	CTTD1 0725	CTTD1 0825	CTTD1 0925		
	106 7/8" [2715]	106 5/16" [2700]	103 3/16" [2620]	90 11/16" [2304]	CTTD1 0727	CTTD1 0827	CTTD1 0927		

Swinging Terrace & French Doors -
2.25 Inch - **Standard Stile (>3") TD**

Size Charts

Cambertop TD1 Non-Clad

				Width				
Height	Rough Opening	Frame		31 1/4" [793]	34 1/2" [876]	38 11/16" [983]	41 1/16" [1043]	44 5/8" [1134]
		Panel	Visible Glass	30 1/2" [774]	33 3/4" [857]	37 15/16" [964]	40 5/16" [1024]	43 7/8" [1115]
				28 1/2" [724]	31 3/4" [587]	36" [914]	38 3/8" [974]	41 15/16" [1065]
				19 13/16" [504]	23 1/8" [587]	27 5/16" [694]	29 11/16" [754]	33 1/4" [845]
80 1/8" [2035]	79 1/2" [2020]	77" [1956]	64 13/16" [1646]	CTTD1 0720	CTTD1 0820	CTTD1 0920	CTTD1 1020	CTTD1 1120
81 7/8" [2080]	81 5/16" [2065]	78 3/4" [2001]	66 9/16" [1691]	CTTD1 0721	CTTD1 0821	CTTD1 0921	CTTD1 1021	CTTD1 1121
86 9/16" [2199]	86" [2184]	83 7/16" [2120]	71 4/4" [1810]	CTTD1 0770	CTTD1 0870	CTTD1 0970	CTTD1 1070	CTTD1 1170
95 1/16" [2415]	94 1/2" [2400]	91 15/16" [2336]	79 3/4" [2026]	CTTD1 0724	CTTD1 0824	CTTD1 0924	CTTD1 1024	CTTD1 1124
98" [2489]	97 3/8" [2474]	94 5/8" [2410]	82 11/16" [2100]	CTTD1 0780	CTTD1 0880			
99 5/8" [2531]	99 1/16" [2516]	96 9/16" [2452]	84 5/16" [2142]	CTTD1 0725	CTTD1 0825			
106 7/8" [2715]	106 5/16" [2700]	103 3/4" [2636]	91 9/16" [2326]	CTTD1 0727	CTTD1 0827			

Swinging Terrace & French Doors -
2.25 Inch - **Standard Stile (>3") TD**

Size Charts

Cambertop TD2 Metal-Clad

Width

Rough Opening				46 1/8" [1171]	59 13/16" [1519]	66 5/16" [1685]	70 5/8" [1819]	79 1/2" [2019]	86 5/8" [2201]
	Frame			45 3/8" [1152]	59 1/16" [1500]	65 9/16" [1666]	70 7/8" [1800]	78 3/4" [2000]	85 7/8" [2182]
	Panel			21 5/8" [550]	28 1/2" [724]	31 3/4" [807]	34 7/16" [874]	38 3/8" [974]	41 15/16" [1065]
	Visible Glass			13" [330]	19 13/16" [504]	23 1/8" [587]	25 3/4" [654]	29 11/16" [754]	33 1/4" [845]
80 1/8" [2035]	79 1/2" [2020]	76 3/8" [1940]	63 3/4" [1619]	CTTD2 1220	CTTD2 1520	CTTD2 1620	CTTD2 1820	CTTD2 2020	CTTD2 2220
81 7/8" [2080]	81 5/16" [2065]	78 3/16" [1985]	65 1/2" [1664]	CTTD2 1221	CTTD2 1521	CTTD2 1621	CTTD2 1821	CTTD2 2021	CTTD2 2221
86 9/16" [2199]	86" [2184]	82 7/8" [2104]	70 3/16" [1783]	CTTD2 1270	CTTD2 1570	CTTD2 1670	CTTD2 1870	CTTD2 2070	CTTD2 2270
95 1/16" [2415]	94 1/2" [2400]	91 3/8" [2320]	78 11/16" [1999]	CTTD2 1224	CTTD2 1524	CTTD2 1624	CTTD2 1824	CTTD2 2024	CTTD2 2224
98" [2489]	97 3/8" [2474]	94 1/4" [2394]	81 5/8" [2073]	CTTD2 1280	CTTD2 1580	CTTD2 1680	CTTD2 1880	CTTD2 2080	CTTD2 2280
99 5/8" [2531]	99 1/16" [2516]	95 15/16" [2436]	83 5/16" [2115]	CTTD2 1225	CTTD2 1525	CTTD2 1625	CTTD2 1825		
106 7/8" [2715]	106 5/16" [2700]	103 3/16" [2620]	90 1/2" [2299]	CTTD2 1227	CTTD2 1527	CTTD2 1627	CTTD2 1827		

Height

Swinging Terrace & French Doors -
2.25 Inch - **Standard Stile (>3") TD**

Size Charts

Cambertop TD2 Non-Clad

		Width							
Height	Rough Opening	Frame		Panel		Visible Glass			
		Panel		Visible Glass					
		Visible Glass							
		59 13/16" [1519]	66 5/16" [1685]	74 3/4" [1899]	79 1/2" [2019]	86 5/8" [2201]			
		59 1/16" [1500]	65 9/16" [1666]	74 1/16" [1882]	78 3/4" [2000]	85 7/8" [2182]			
		28 7/16" [723]	31 3/4" [806]	35 15/16" [913]	38 5/16" [973]	41 7/8" [1064]			
		19 13/16" [503]	23 1/16" [586]	27 5/16" [693]	29 5/8" [753]	33 1/4" [844]			
	80 1/8" [2035]	79 1/2" [2020]	77" [1956]	64 13/16" [1646]	CTTD2 1520	CTTD2 1620	CTTD2 1820	CTTD2 2020	CTTD2 2220
	81 7/8" [2080]	81 5/16" [2065]	78 3/4" [2001]	66 9/16" [1691]	CTTD2 1521	CTTD2 1621	CTTD2 1821	CTTD2 2021	CTTD2 2221
	86 9/16" [2199]	86" [2184]	83 7/16" [2120]	71 4/4" [1810]	CTTD2 1570	CTTD2 1670	CTTD2 1870	CTTD2 2070	CTTD2 2270
	95 1/16" [2415]	94 1/2" [2400]	91 15/16" [2336]	79 3/4" [2026]	CTTD2 1524	CTTD2 1624	CTTD2 1824	CTTD2 2024	CTTD2 2224
	98" [2489]	97 3/8" [2474]	94 57/8" [2410]	82 11/16" [2100]	CTTD2 1580	CTTD2 1680			
	99 5/8" [2531]	99 1/16" [2516]	96 9/16" [2452]	84 5/16" [2142]	CTTD2 1525	CTTD2 1625			
	106 7/8" [2715]	106 5/16" [2700]	103 3/4" [2636]	91 9/16" [2326]	CTTD2 1527	CTTD2 1627			

Swinging Terrace & French Doors -
2.25 Inch - **Standard Stile (>3") TD**

Size Charts

Quarter Round TD1 Metal-Clad

Width

Height	Rough Opening				31 1/4" [793]		34 1/2" [876]		
					Frame		30 1/2" [774]		33 3/4" [857]
	Panel			28 9/16" [726]		31 7/8" [809]			
					Visible Glass		20 1/8" [511]		23 3/8" [594]
95 1/16" [2415]	94 1/2" [2400]	91 3/8" [2321]	78 3/8" [1991]	CTTD1 0724					
98" [2489]	97 3/8" [2474]	94 1/4" [2395]	81 5/16" [2065]	CTTD1 0780					
99 5/8" [2531]	99 1/16" [2516]	95 15/16" [2437]	82 15/16" [2107]	CTTD1 0725					
106 7/8" [2715]	106 5/16" [2700]	103 3/16" [2621]	90 3/16" [2291]	CTTD1 0727	CTTD1 0827				

Swinging Terrace & French Doors -
2.25 Inch - **Standard Stile (>3") TD**

Size Charts

Quarter Round TD1 Non-Clad

				Width	
Height	Rough Opening			31 1/4" [793]	34 1/2" [876]
	Frame		Panel		
	Frame		Visible Glass		Panel
	Frame		Visible Glass		Panel
95 1/16" [2415]	94 1/2" [2400]	91 3/8" [2321]	78 3/8" [1991]	CTTD1 0724	
98" [2489]	97 3/8" [2474]	94 1/4" [2395]	81 5/16" [2065]	CTTD1 0780	
99 5/8" [2531]	99 1/16" [2516]	95 15/16" [2437]	82 15/16" [2107]	CTTD1 0725	
106 7/8" [2715]	106 5/16" [2700]	103 3/16" [2621]	90 3/16" [2291]	CTTD1 0727	CTTD1 0827

Swinging Terrace & French Doors -
2.25 Inch - **Standard Stile (>3") TD**

Size Charts

Quarter Round TD2 Metal-Clad

Width

		Rough Opening Inswing with Jamb Extension			60 7/16" [1535]	66 15/16" [1701]	
		Rough Opening		Frame	59 13/16" [1519]	66 5/16" [1685]	
					59 1/16" [1500]	65 9/16" [1666]	
					Panel	28 9/16" [726]	31 7/8" [809]
					Visible Glass	19 15/16" [506]	23 3/16" [589]
Height	95 3/8" [2422]	95 1/16" [2415]	94 1/2" [2400]	91 7/16" [2322]	78 3/8" [1990]	CTTD2 1524	
	98 1/4" [2496]	98" [2489]	97 3/8" [2474]	94 5/16" [2396]	81 3/4" [2077]	CTTD2 1580	
	99 15/16" [2538]	99 5/8" [2531]	99 1/16" [2516]	96" [2438]	82 15/16" [2106]	CTTD2 1525	
	107 3/16" [2722]	106 7/8" [2715]	106 5/16" [2700]	103 1/4" [2622]	90 3/16" [2290]	CTTD2 1527	CTTD2 1627

Swinging Terrace & French Doors -
2.25 Inch - **Standard Stile (>3") TD**

Size Charts

Quarter Round TD2 Non-Clad

←————— **Width** —————→

Height	Rough Opening Inswing with Jamb Extension					60 7/16" [1535]	66 15/16" [1701]
	Rough Opening					59 13/16" [1519]	66 5/16" [1685]
	Frame					59 1/16" [1500]	65 9/16" [1666]
	Panel					28 9/16" [726]	31 7/8" [809]
	Visible Glass					19 15/16" [506]	23 3/16" [589]
95 3/8" [2422]	95 1/16" [2415]	94 1/2" [2400]	91 7/16" [2322]	78 3/8" [1990]	CTTD2 1524		
98 1/4" [2496]	98" [2489]	97 3/8" [2474]	94 5/16" [2396]	81 3/4" [2077]	CTTD2 1580		
99 15/16" [2538]	99 5/8" [2531]	99 1/16" [2516]	96" [2438]	82 15/16" [2106]	CTTD2 1525		
107 3/16" [2722]	106 7/8" [2715]	106 5/16" [2700]	103 1/4" [2622]	90 3/16" [2290]	CTTD2 1527	CTTD2 1627	

Swinging Terrace & French Doors -
2.25 Inch - **Standard Stile (>3") TD**

Size Charts

Half Round TD1 Metal-Clad

← Width →

		Rough Opening			35 1/82" [892]		37 3/4" [959]							
		Rough Opening					34 1/2" [876]		37 1/8" [943]					
				Frame					33 3/4" [857]		36 3/8" [924]			
						Panel					31 7/8" [809]		34 1/2" [876]	
								Visible Glass					23 3/16" [589]	
Height	82 3/16" [2087]	81 7/8" [2080]	81 5/16" [2065]	78 1/4" [1987]	65 11/16" [1668]	CTTD1 0821	CTTD1 0921							
	86 7/8" [2206]	86 9/16" [2199]	86" [2184]	82 15/16" [2106]	70 3/8" [1787]	CTTD1 0870	CTTD1 0970							
	95 3/8" [2422]	95 1/16" [2415]	94 1/2" [2400]	91 7/16" [2322]	78 7/8" [2003]	CTTD1 0824	CTTD1 0924							
	98 1/4" [2496]	98" [2489]	97 3/8" [2474]	94 5/16" [2396]	81 3/4" [2077]	CTTD1 0880	CTTD1 0980							
	99 15/16" [2538]	99 5/8" [2531]	99 1/16" [2516]	96" [2438]	83 7/16" [2119]	CTTD1 0825	CTTD1 0925							
	107 3/16" [2722]	106 7/8" [2715]	106 5/16" [2700]	103 1/4" [2622]	90 11/16" [2303]	CTTD1 0827								

Swinging Terrace & French Doors -
2.25 Inch - **Standard Stile (>3") TD**

Drawings

Outswing

HEAD & SILL DETAILS

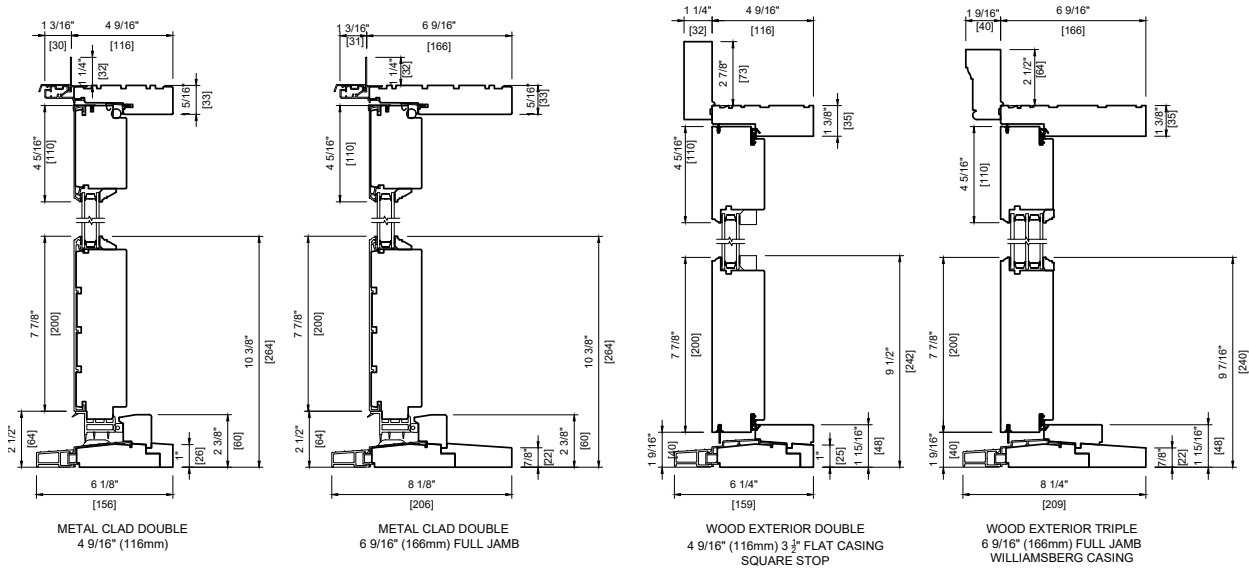

HEAD & SILL DETAILS

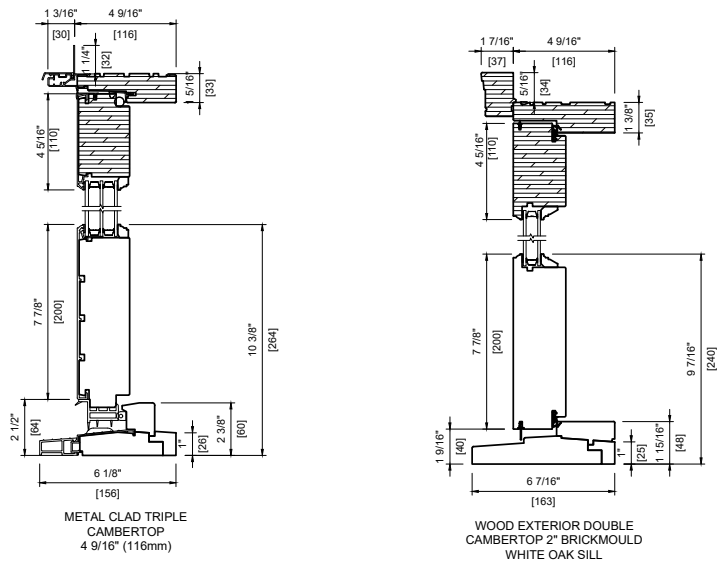

GLAZING STOP PROFILES

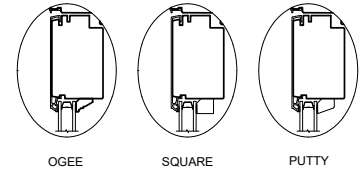

CASING

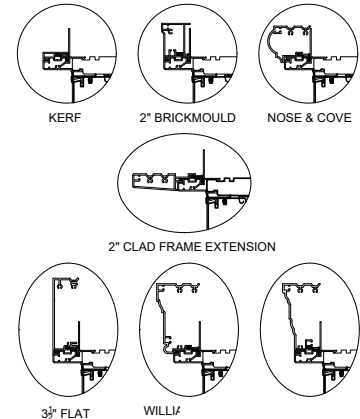

SEE PAGE A22 FOR DIMENSIONS.

Swinging Terrace & French Doors -
2.25 Inch - **Standard Stile (>3") TD**

Drawings

Outswing (cont'd)

PLAN VIEW

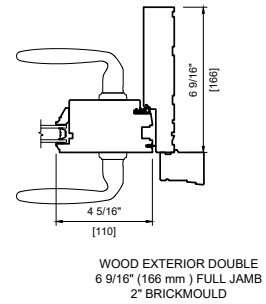
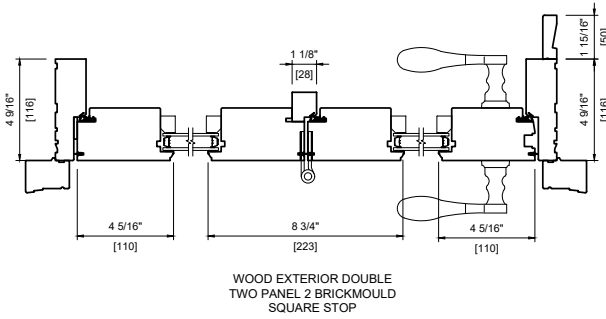
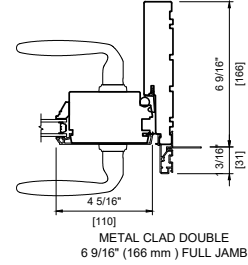
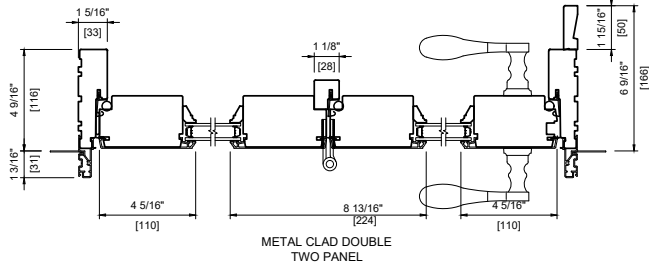

PLAN VIEW

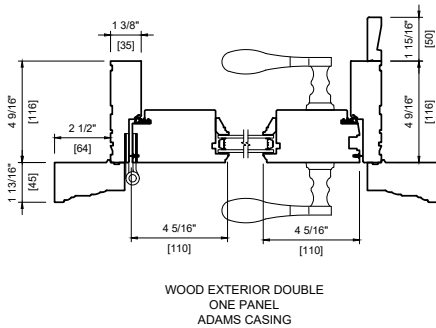
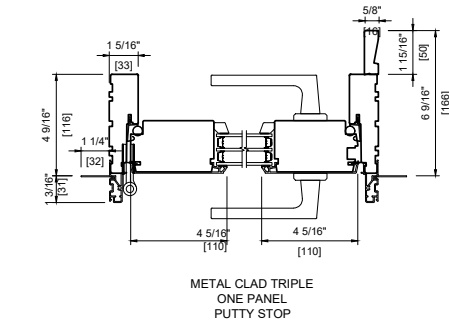

GLAZING STOP PROFILES

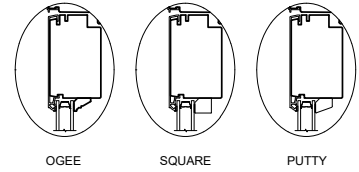

CASING

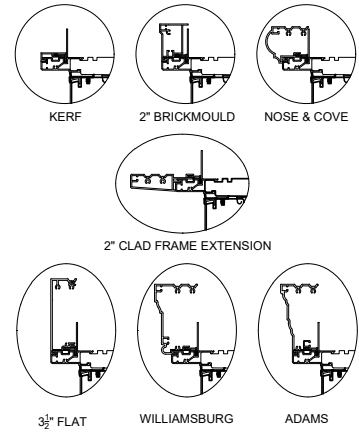

Swinging Terrace & French Doors -
2.25 Inch - **Standard Stile (>3") TD**

Drawings

3 & 4 Wide Outswing

PLAN VIEW

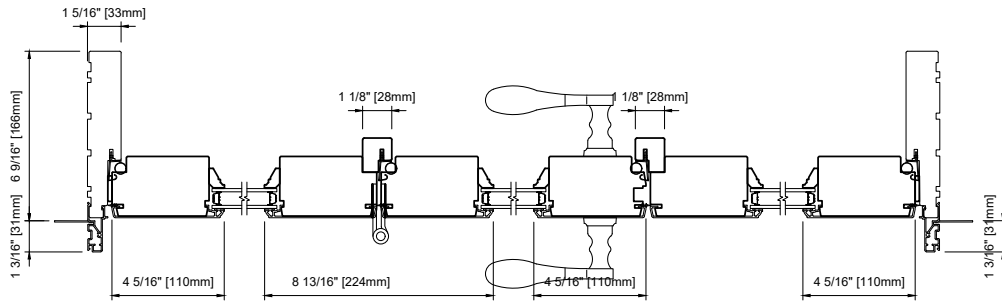

METAL CLAD DOUBLE
3 WIDE

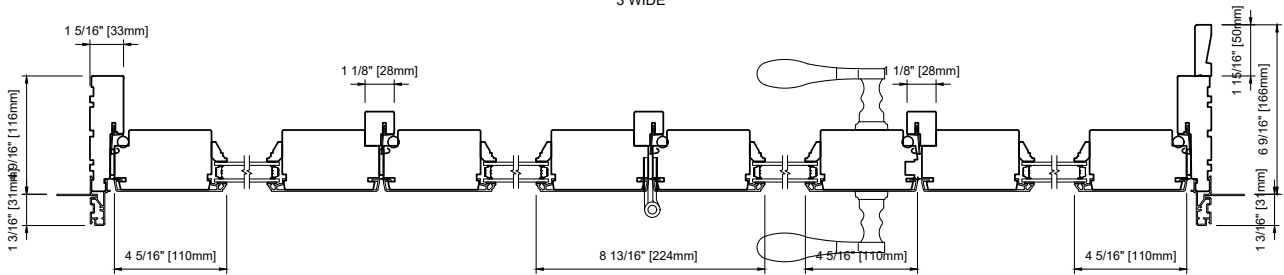

METAL CLAD DOUBLE
4 WIDE

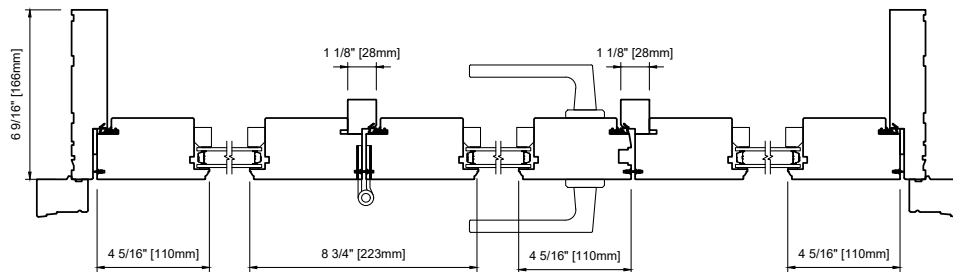

WOOD EXTERIOR DOUBLE
3 WIDE
2 BRICKMOULD, SQUARE STOP

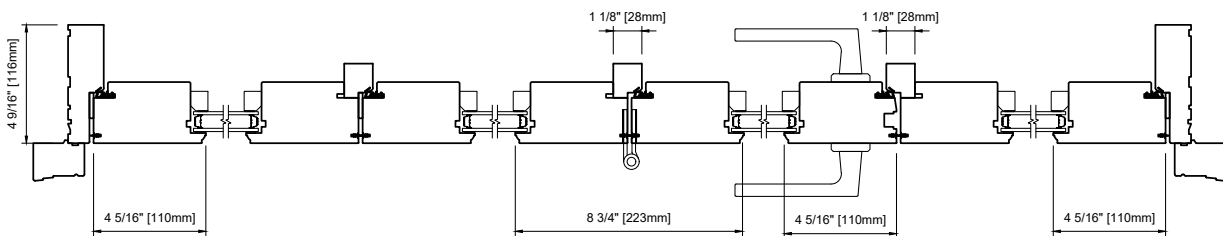

WOOD EXTERIOR DOUBLE
4 WIDE
2 BRICKMOULD, SQUARE STOP

Swinging Terrace & French Doors -
2.25 Inch - **Standard Stile (>3") TD**

Drawings

Outswing Transom

HEAD & SILL

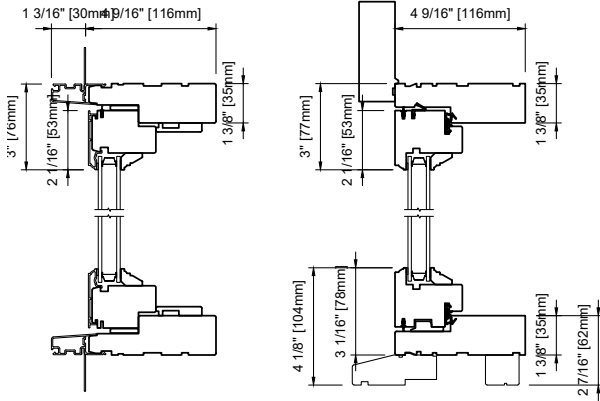

METAL CLAD DOUBLE
2 1/16" (53mm) RAILS

WOOD EXTERIOR DOUBLE
2 1/16" (53mm) RAILS

PLAN VIEW

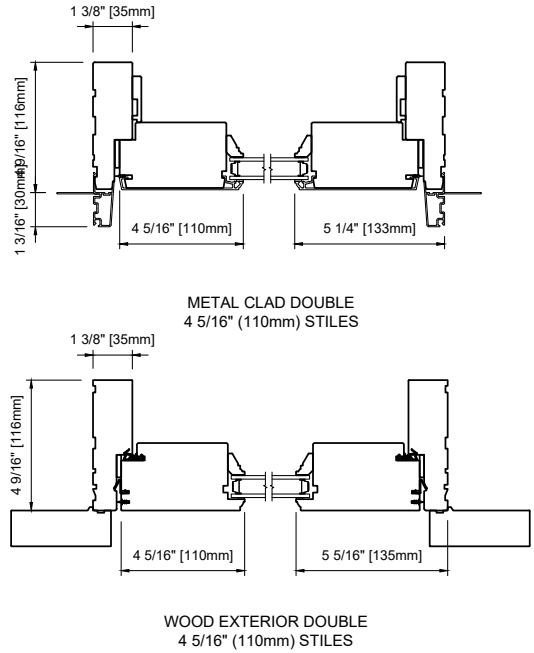

METAL CLAD DOUBLE
4 5/16" (110mm) STILES

WOOD EXTERIOR DOUBLE
4 5/16" (110mm) STILES

PLAN VIEW

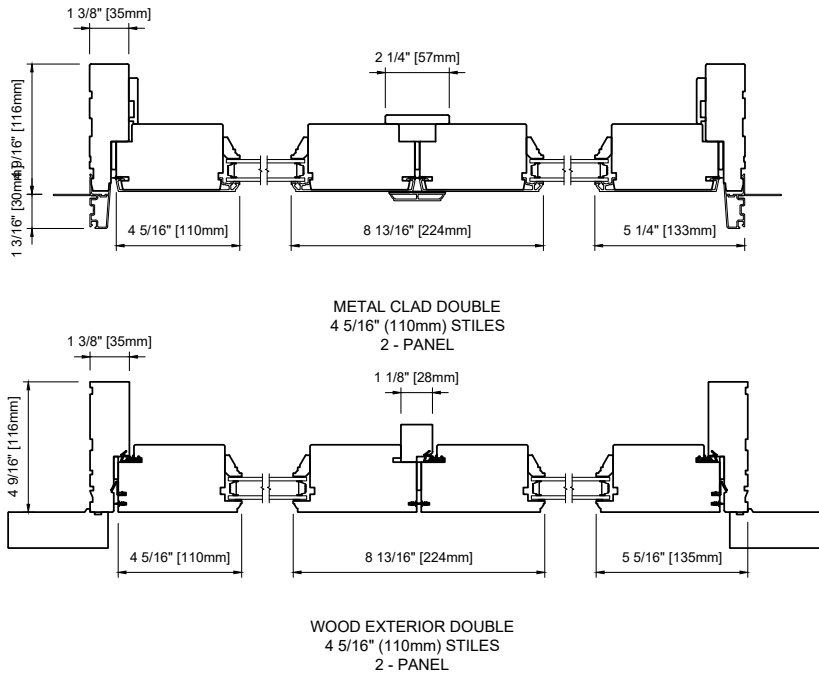

METAL CLAD DOUBLE
4 5/16" (110mm) STILES
2 - PANEL

WOOD EXTERIOR DOUBLE
4 5/16" (110mm) STILES
2 - PANEL

Swinging Terrace & French Doors -
2.25 Inch - **Narrow Stile (3")** FD

Size Charts

FD2 Metal-Clad

Width

Rough Opening Inswing with Jamb Extension					61 9/16" [1564]	68 1/8" [1730]	73 3/8" [1864]	81 1/4" [2064]				
					Rough Opening				60 15/16" [1548]	67 1/2" [1714]	72 3/4" [1848]	80 5/8" [2048]
					Frame				60 3/16" [1529]	66 3/4" [1695]	72" [1829]	79 7/8" [2029]
					Panel				28 9/16" [726]	31 7/8" [809]	34 1/2" [876]	38 7/16" [976]
					Visible Glass				22 11/16" [576]	25 15/16" [659]	28 9/16" [726]	32 1/2" [826]
					TRANSOM							
16 5/8" [422]	16 5/16" [415]	15 3/4" [400]	13 7/8" [352]	9 11/16" [246]	*FDT2 1504	*FDT2 1604	*FDT2 1804	*FDT2 2004				
24 1/2" [622]	24 3/16" [615]	23 5/8" [600]	21 3/4" [552]	17 9/16" [446]	*FDT2 1506	*FDT2 1606	*FDT2 1806	*FDT2 2006				
					DOOR							
80 3/8" [2042]	80 1/8" [2035]	79 1/2" [2020]	76 7/16" [1942]	68 13/16" [1748]	FD2 1520	FD2 1620	FD2 1820	FD2 2020				
82 3/16" [2087]	81 7/8" [2080]	81 5/16" [2065]	78 1/4" [1987]	70 9/16" [1793]	FD2 1521	FD2 1621	FD2 1821	FD2 2021				
86 7/8" [2206]	86 9/16" [2199]	86" [2184]	82 15/16" [2106]	75 1/4" [1912]	FD2 1570	FD2 1670	FD2 1870	FD2 2070				
95 3/8" [2422]	95 1/16" [2415]	94 1/2" [2400]	91 7/16" [2322]	83 3/4" [2128]	FD2 1524	FD2 1624	FD2 1824	FD2 2024				
98 1/4" [2496]	98" [2489]	97 3/8" [2474]	94 5/16" [2396]	86 11/16" [2202]	FD2 1580	FD2 1680	FD2 1880					
99 15/16" [2538]	99 5/8" [2531]	99 1/16" [2516]	96" [2438]	88 3/8" [2244]	FD2 1525	FD2 1625	FD2 1825					
107 3/16 [2722]	106 7/8" [2715]	106 5/16" [2700]	103 1/4" [2622]	95 9/16" [2428]	FD2 1527	FD2 1627	FD2 1827					

Height

* Transom units

Swinging Terrace & French Doors -
2.25 Inch - **Narrow Stile (3") FD**

Size Charts

FD2 Non-Clad

				Width						
Rough Opening					60 15/16" [1548]	67 1/2" [1714]	75 13/16" [1926]	80 5/8" [2048]		
				Frame			60 3/16" [1529]	66 3/4" [1695]	75 1/16" [1907]	79 7/8" [2029]
				Panel		28 9/16" [725]	31 13/16" [808]	36" [914]	38 3/8" [975]	
				Visible Glass		22 5/8" [575]	25 7/8" [658]	30 1/16" [764]	32 1/2" [825]	
				TRANSOM						
16 1/2" [419]	15 3/4" [400]	13 7/8" [352]	9 11/16" [246]	*FDT2 1504	*FDT2 1604	*FDT2 1804	*FDT2 2004			
24 3/8" [619]	23 5/8" [600]	21 3/4" [552]	17 9/16" [446]	*FDT2 1506	*FDT2 1606	*FDT2 1806	*FDT2 2006			
32 1/4" [819]	31 1/2" [800]	29 9/16" [751]	25 3/8" [645]	*FDT2 1508	*FDT2 1608	*FDT2 1808	*FDT2 2008			
				DOOR						
80 1/8" [2035]	79 1/2" [2020]	77" [1956]	69 3/4" [1771]	FD2 1520	FD2 1620	FD2 1820	FD2 2020			
81 7/8" [2080]	81 5/16" [2065]	78 3/4" [2001]	71 1/2" [1816]	FD2 1521	FD2 1621	FD2 1821	FD2 2021			
86 9/16" [2199]	86" [2184]	83 7/16" [2120]	76 3/16" [1935]	FD2 1570	FD2 1670	FD2 1870	FD2 2070			
95 1/16" [2415]	94 1/2" [2400]	91 15/16" [2336]	84 11/16" [2151]	FD2 1524	FD2 1624	FD2 1824	FD2 2024			
98" [2489]	97 3/8" [2474]	94 7/8" [2410]	87 5/8" [2225]	FD2 1580	FD2 1680	FD2 1880	FD2 2080			
99 5/8" [2531]	99 1/16" [2516]	96 9/16" [2452]	89 1/4" [2267]	FD2 1525	FD2 1625	FD2 1825	FD2 2025			
106 7/8" [2715]	106 5/16" [2700]	103 3/4" [2636]	96 1/2" [2451]	FD2 1527	FD2 1627	FD2 1827	FD2 2027			
124" [3150]	123 7/16" [3135]	120 7/8" [3071]	113 5/8" [2886]	FD2 1532	FD2 1632	FD2 1832	FD2 2032			

Height

* Transom units

Swinging Terrace & French Doors -
2.25 Inch - **Narrow Stile (3") FD**

Size Charts

FD3 Metal-Clad

					Width						
Rough Opening Inswing with Jamb Extension					90 3/16" [2290]	100" [2539]	107 7/8" [2740]				
					Rough Opening				89 1/2" [2274]	99 5/16" [2523]	107 1/4" [2724]
					Frame				88 3/4" [2255]	98 9/16" [2504]	106 1/2" [2705]
					Panel				28 9/16" [726]	31 7/8" [809]	34 1/2" [876]
					Visible Glass				22 11/16" [576]	25 15/16" [659]	28 9/16" [726]
					TRANSOM						
16 5/8" [422]	16 5/16" [415]	15 3/4" [400]	13 7/8" [352]	9 11/16" [246]	*FDT3 2204	*FDT3 2404	*FDT3 2704				
24 1/2" [622]	24 3/16" [615]	23 5/8" [600]	21 3/4" [552]	17 9/16" [446]	*FDT3 2206	*FDT3 2406	*FDT3 2706				
					DOOR						
80 3/8" [2042]	80 1/8" [2035]	79 1/2" [2020]	76 7/16" [1942]	68 13/16" [1748]	FD3 2220	FD3 2420	FD3 2720				
82 3/16" [2087]	81 7/8" [2080]	81 5/16" [2065]	78 1/4" [1987]	70 9/16" [1793]	FD3 2221	FD3 2421	FD3 2721				
86 7/8" [2206]	86 9/16" [2199]	86" [2184]	82 15/16" [2106]	75 1/4" [1912]	FD3 2270	FD3 2470	FD3 2770				
95 3/8" [2422]	95 1/16" [2415]	94 1/2" [2400]	91 7/16" [2322]	83 3/4" [2128]	FD3 2224	FD3 2424	FD3 2724				
98 1/4" [2496]	98" [2489]	97 3/8" [2474]	94 5/16" [2396]	86 11/16" [2202]	FD3 2280	FD3 2480	FD3 2780				
99 15/16" [2538]	99 5/8" [2531]	99 1/16" [2516]	96" [2438]	88 3/8" [2244]	FD3 2225	FD3 2425	FD3 2725				
107 3/16" [2722]	106 7/8" [2715]	106 5/16" [2700]	103 1/4" [2622]	95 9/16" [2428]	FD3 2227	FD3 2427	FD3 2727				

* Transom units

Swinging Terrace & French Doors -
2.25 Inch - **Narrow Stile (3") FD**

Size Charts

FD3 Non-Clad

				Width			
Rough Opening							
				Frame			
				Panel			
				Visible Glass			
				99 5/16" [2523]	111 15/16" [2844]		
				98 9/16" [2504]	111 4/4" [2825]		
				31 3/4" [807]	36" [914]		
				25 7/8" [657]	30 1/16" [764]		
TRANSOM							
16 1/2" [419]	15 3/4" [400]	13 7/8" [352]	9 11/16" [246]	*FDT3 2404	*FDT3 2704		
24 3/8" [619]	23 5/8" [600]	21 3/4" [552]	17 9/16" [446]	*FDT3 2406	*FDT3 2706		
32 1/4" [819]	31 1/2" [800]	29 9/16" [751]	25 3/8" [645]	*FDT3 2408	*FDT3 2708		
DOOR							
80 1/8" [2035]	79 1/2" [2020]	77" [1956]	69 3/4" [1771]	FD3 2420	FD3 2720		
81 7/8" [2080]	81 5/16" [2065]	78 3/4" [2001]	71 1/2" [1816]	FD3 2421	FD3 2721		
86 9/16" [2199]	86" [2184]	83 7/16" [2120]	76 3/16" [1935]	FD3 2470	FD3 2770		
95 1/16" [2415]	94 1/2" [2400]	91 15/16" [2336]	84 11/16" [2151]	FD3 2424	FD3 2724		
98" [2489]	97 3/8" [2474]	94 7/8" [2410]	87 5/8" [2225]	FD3 2480	FD3 2780		
99 5/8" [2531]	99 1/16" [2516]	96 9/16" [2452]	89 1/4" [2267]	FD3 2425	FD3 2725		
106 7/8" [2715]	106 5/16" [2700]	103 3/4" [2636]	96 1/2" [2451]	FD3 2427			

* Transom units

Swinging Terrace & French Doors -
2.25 Inch - **Narrow Stile (3")** FD

Size Charts

FD4 Metal-Clad

Width

Height

Rough Opening Inswing with Jamb Extension					118 3/4" [3016]	131 13/16" [3348]	142 3/8" [3616]	158 1/8" [4016]
Rough Opening					118 1/8" [3000]	131 3/16" [3332]	141 3/4" [3600]	157 1/2" [4000]
		Frame			117 3/8" [2981]	130 7/16" [3313]	141" [3581]	156 3/4" [3981]
				Panel	28 9/16" [726]	31 7/8" [809]	34 1/2" [876]	38 7/16" [976]
				Visible Glass	22 11/16" [576]	25 15/16" [659]	28 9/16" [726]	32 1/2" [826]
					TRANSOM			
16 5/8" [422]	16 5/16" [415]	15 3/4" [400]	13 7/8" [352]	9 11/16" [246]	*FDT4 3004	*FDT4 3304	*FDT4 3604	*FDT4 4004
24 1/2" [622]	24 3/16" [615]	23 5/8" [600]	21 3/4" [552]	17 9/16" [446]	*FDT4 3006	*FDT4 3306	*FDT4 3606	*FDT4 4006
					DOOR			
80 3/8" [2042]	80 1/8" [2035]	79 1/2" [2020]	76 7/16" [1942]	68 13/16" [1748]	FD4 3020	FD4 3320	FD4 3620	FD4 4020
82 3/16" [2087]	81 7/8" [2080]	81 5/16" [2065]	78 1/4" [1987]	70 9/16" [1793]	FD4 3021	FD4 3321	FD4 3621	FD4 4021
86 7/8" [2206]	86 9/16" [2199]	86" [2184]	82 15/16" [2106]	75 1/4" [1912]	FD4 3070	FD4 3370	FD4 3670	FD4 4070
95 3/8" [2422]	95 1/16" [2415]	94 1/2" [2400]	91 7/16" [2322]	83 3/4" [2128]	FD4 3024	FD4 3324	FD4 3624	FD4 4024
98 1/4" [2496]	98" [2489]	97 3/8" [2474]	94 5/16" [2396]	86 11/16" [2202]	FD4 3080	FD4 3380	FD4 3680	
99 15/16" [2538]	99 5/8" [2531]	99 1/16" [2516]	96" [2438]	88 3/8" [2244]	FD4 3025	FD4 3325	FD4 3625	
107 3/16" [2722]	106 7/8" [2715]	106 5/16" [2700]	103 1/4" [2622]	95 9/16" [2428]	FD4 3027	FD4 3327	FD4 3627	

* Transom units

Swinging Terrace & French Doors -
2.25 Inch - **Narrow Stile (3") FD**

Size Charts

FD4 Non-Clad

				Width	
Height	Rough Opening			131 3/16" [3332]	157 1/2" [4000]
	Frame			130 7/16" [3313]	156 3/4" [3981]
	Panel			31 3/4" [806]	38 5/16" [973]
	Visible Glass			25 7/8" [656]	32 7/16" [823]
				TRANSOM	
16 1/2" [419]	15 3/4" [400]	13 7/8" [352]	9 11/16" [246]	*FDT4 3304	*FDT4 4004
24 3/8" [619]	23 5/8" [600]	21 3/4" [552]	17 9/16" [446]	*FDT4 3306	*FDT4 4006
32 1/4" [819]	31 1/2" [800]	29 9/16" [751]	25 3/8" [645]	*FDT4 3308	*FDT4 4008
				DOOR	
80 1/8" [2035]	79 1/2" [2020]	77" [1956]	69 3/4" [1771]	FD4 3320	FD4 4020
81 7/8" [2080]	81 5/16" [2065]	78 3/4" [2001]	71 1/2" [1816]	FD4 3321	FD4 4021
86 9/16" [2199]	86" [2184]	83 7/16" [2120]	76 3/16" [1935]	FD4 3370	FD4 4070
95 1/16" [2415]	94 1/2" [2400]	91 15/16" [2336]	84 11/16" [2151]	FD4 3324	FD4 4024
98" [2489]	97 3/8" [2474]	94 7/8" [2410]	87 5/8" [2225]	FD4 3380	FD4 4080
99 5/8" [2531]	99 1/16" [2516]	96 9/16" [2452]	89 1/4" [2267]	FD4 3325	FD4 4025
106 7/8" [2715]	106 5/16" [2700]	103 3/4" [2636]	96 1/2" [2451]	FD4 3327	FD4 4027

* Transom units

Swinging Terrace & French Doors -
2.25 Inch - **Narrow Stile (3")** FD

Drawings

Outswing

HEAD & SILL DETAILS

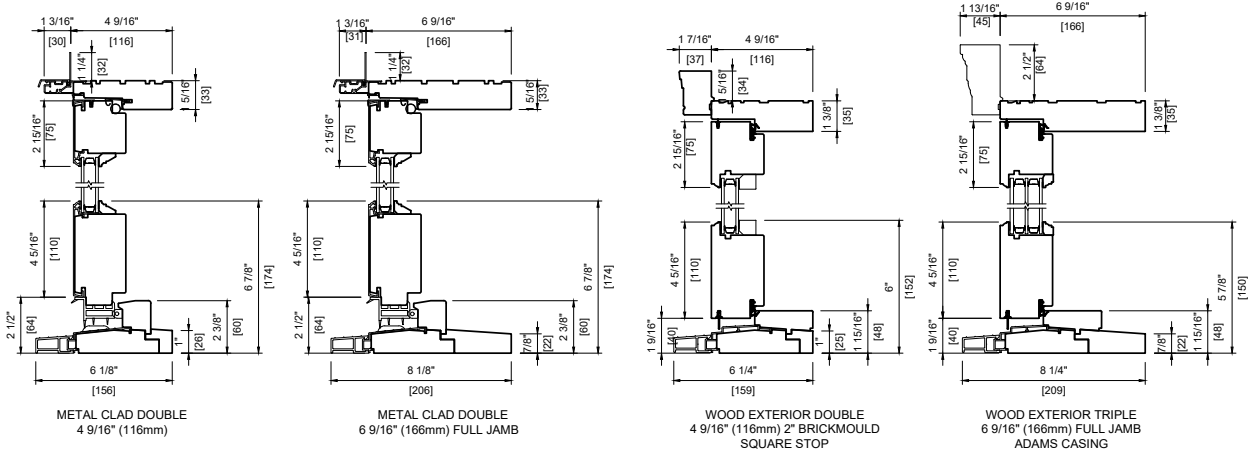

HEAD & SILL DETAILS

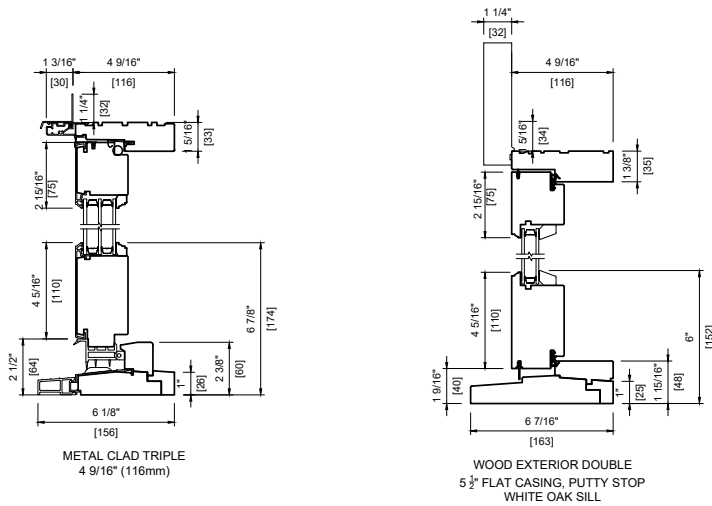

GLAZING STOP PROFILES

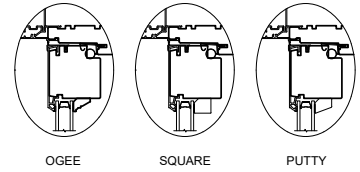

CASING

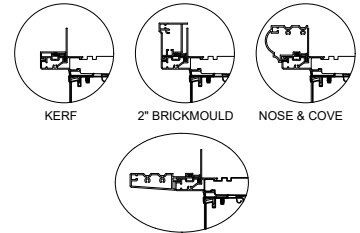

2" CLAD FRAME EXTENSION

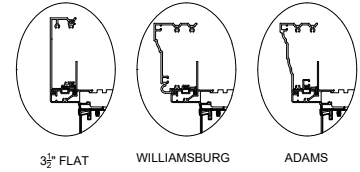

Swinging Terrace & French Doors -
2.25 Inch - **Narrow Stile (3")** FD

Drawings

Outswing (cont'd)

PLAN VIEW

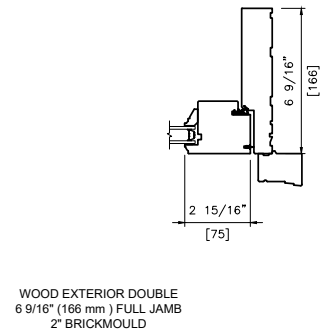
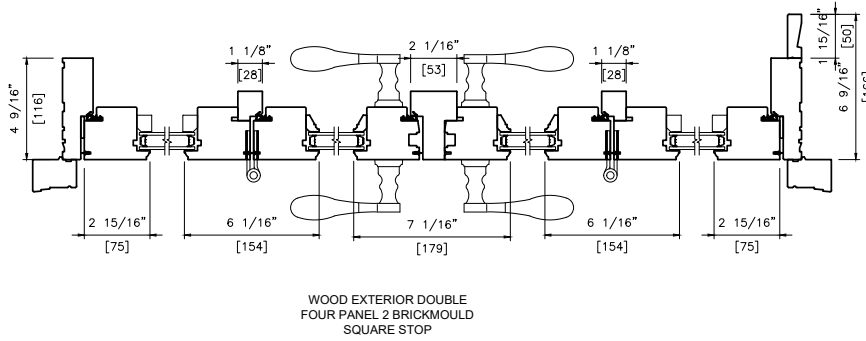
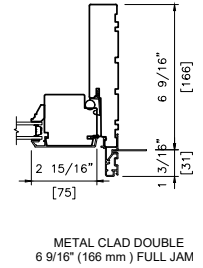
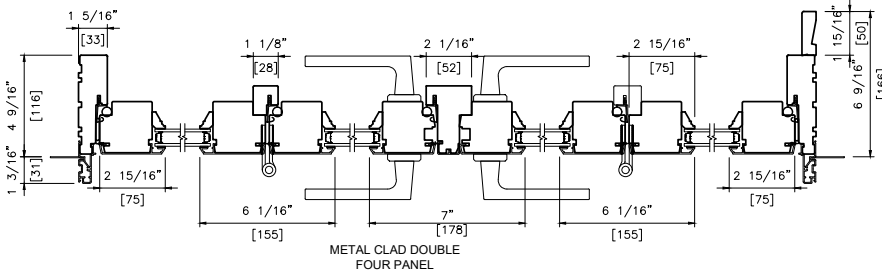

PLAN VIEW

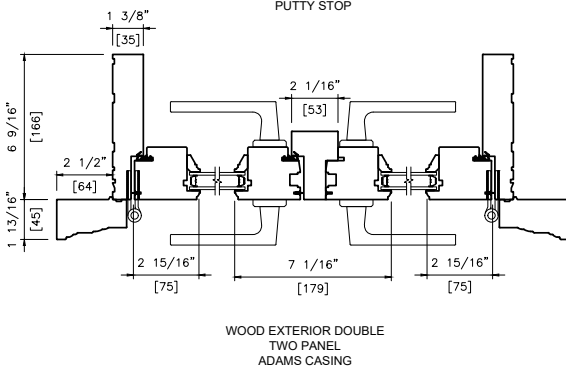
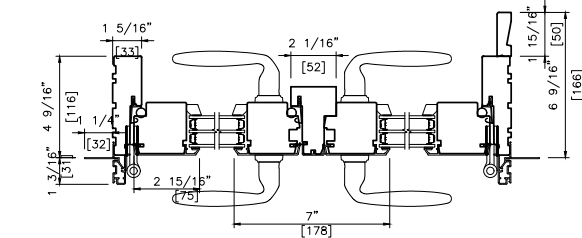

GLAZING STOP PROFILES

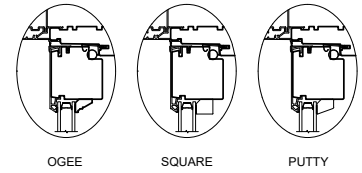

CASING

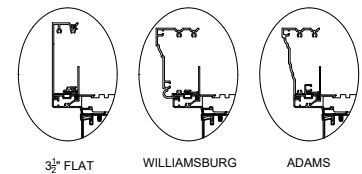
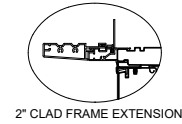
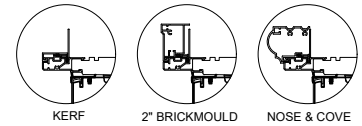

Swinging Terrace & French Doors -
2.25 Inch - **Narrow Stile (3")** FD

Drawings

Outswing (cont'd)

PLAN VIEW

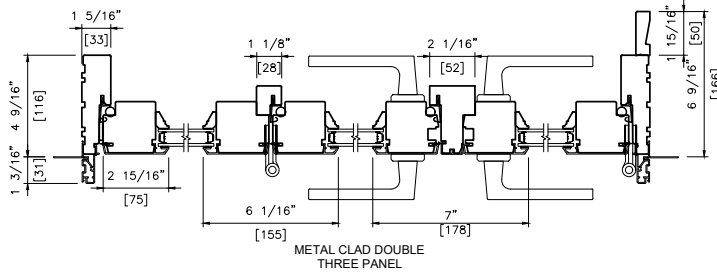

METAL CLAD DOUBLE
THREE PANEL

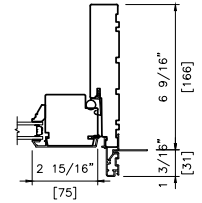

METAL CLAD DOUBLE
6 9/16" (166 mm) FULL JAMB

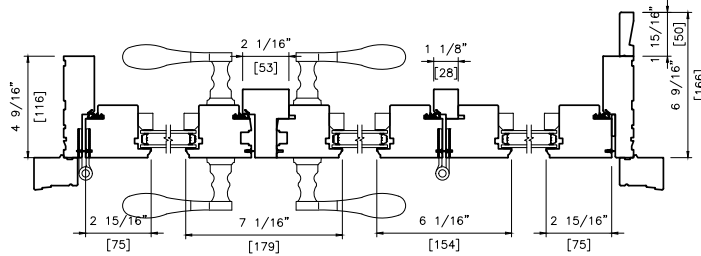

WOOD EXTERIOR DOUBLE
THREE PANEL 2 IN. BRICKMOULD
SQUARE STOP

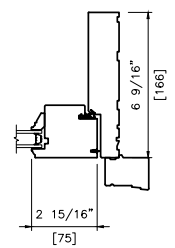

WOOD EXTERIOR DOUBLE
6 9/16" (166 mm) FULL JAMB
2" BRICKMOULD

GLAZING STOP PROFILES

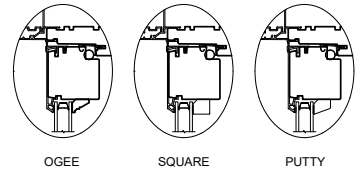

Casing

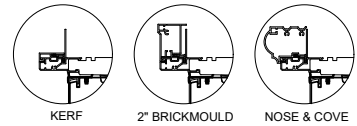

2" CLAD FRAME EXTENSION

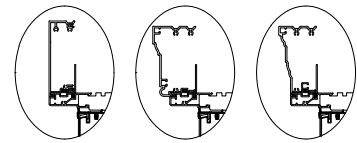

SEE PAGE A22 FOR DIMENSIONS

Swinging Terrace & French Doors -
2.25 Inch - **Narrow Stile (3") FD**

Drawings

Outswing Transom

HEAD & SILL

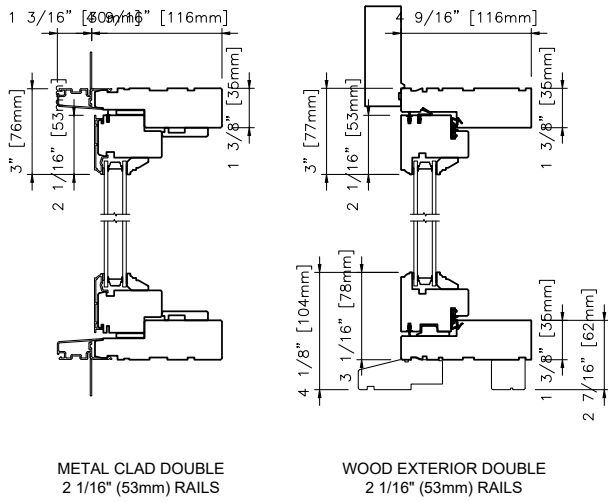

PLAN VIEW

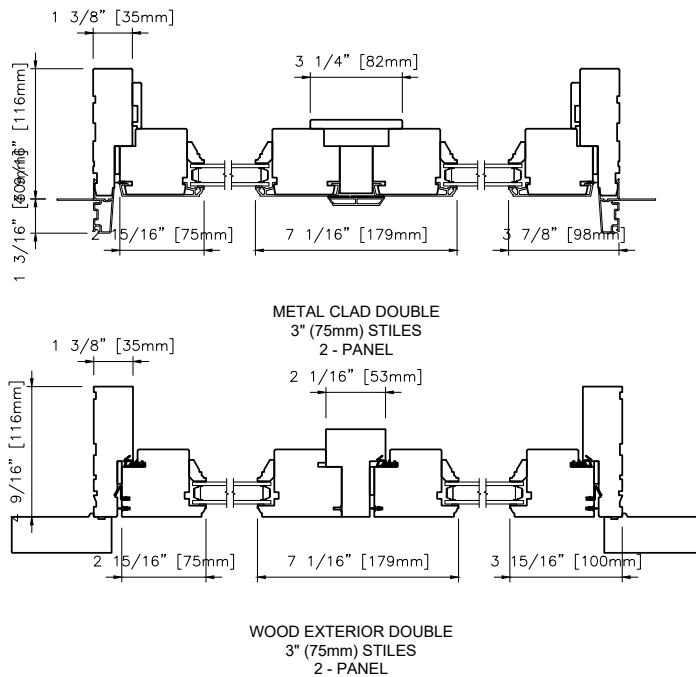

Swinging Terrace & French Doors -
2.25 Inch - **Narrow Stile (3")** FD

Drawings

Outswing Flat Sill, Mid Rail & Bottom Rail

HEAD & SILL DETAILS
MIDRAIL

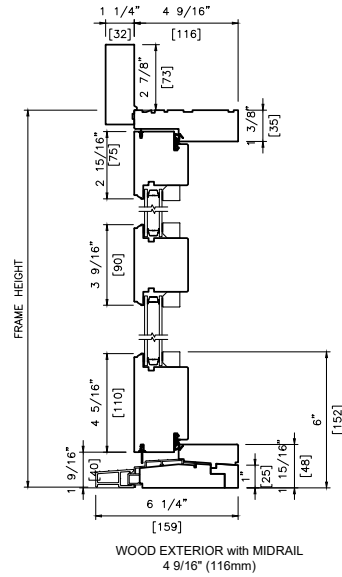
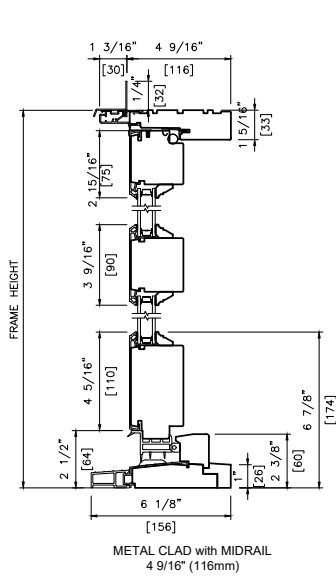

HEAD & SILL DETAILS
LOW PROFILE SILL & TALL BOTTOM RAIL

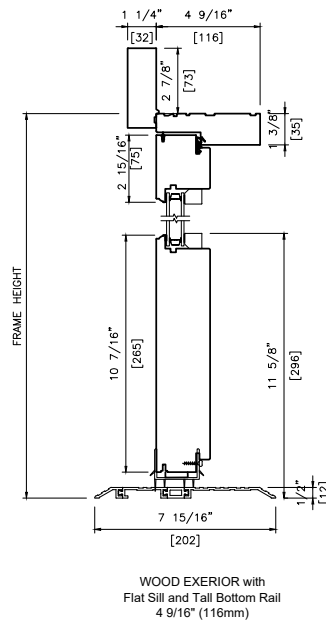
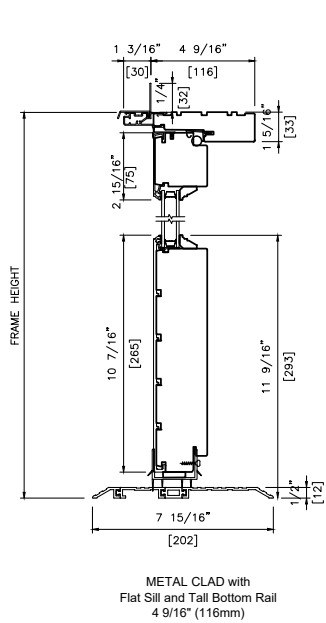

Swinging Terrace & French Doors -
2.25 Inch - **Standard Stile (>3") FD**

Size Charts

FD2 Metal-Clad

Width

Rough Opening Inswing with Jamb Extension					47 7/8" [1216]	61 9/16" [1564]	68 1/8" [1730]	73 3/8" [1864]	81 1/4" [2064]	88 7/16" [2246]					
					Rough Opening					47 1/4" [1200]	60 15/16" [1548]	67 1/2" [1714]	72 3/4" [1848]	80 5/8" [2048]	87 13/16" [2230]
					Frame					46 1/2" [1181]	60 3/16" [1529]	66 3/4" [1695]	72" [1829]	79 7/8" [2029]	87 1/16" [2211]
					Panel					21 3/4" [552]	28 9/16" [726]	31 7/8" [809]	34 1/2" [876]	38 7/16" [976]	42" [1067]
					Visible Glass					13 1/16" [332]	19 15/16" [506]	23 3/16" [589]	25 13/16" [656]	29 3/4" [756]	33 3/8" [847]
					TRANSOM										
16 5/8" [422]	16 5/16" [415]	15 3/4" [400]	13 7/8" [352]	9 11/16" [246]	*FDT2 1204	*FDT2 1504	*FDT2 1604	*FDT2 1804	*FDT2 2004	*FDT2 2204					
24 1/2" [622]	24 3/16" [615]	23 5/8" [600]	21 3/4" [552]	17 9/16" [446]	*FDT2 1206	*FDT2 1506	*FDT2 1606	*FDT2 1806	*FDT2 2006	*FDT2 2206					
					DOOR										
80 3/8" [2042]	80 1/8" [2035]	79 1/2" [2020]	76 7/16" [1942]	63 7/8" [1623]	FD2 1220	FD2 1520	FD2 1620	FD2 1820	FD2 2020	FD2 2220					
82 3/16" [2087]	81 7/8" [2080]	81 5/16" [2065]	78 1/4" [1987]	65 11/16" [1668]	FD2 1221	FD2 1521	FD2 1621	FD2 1821	FD2 2021	FD2 2221					
86 7/8" [2206]	86 9/16" [2199]	86" [2184]	82 15/16" [2106]	70 3/8" [1787]	FD2 1270	FD2 1570	FD2 1670	FD2 1870	FD2 2070	FD2 2270					
95 3/8" [2422]	95 1/16" [2415]	94 1/2" [2400]	91 7/16" [2322]	78 7/8" [2003]	FD2 1224	FD2 1524	FD2 1624	FD2 1824	FD2 2024	FD2 2224					
98 1/4" [2496]	98" [2489]	97 3/8" [2474]	94 5/16" [2396]	81 3/4" [2077]	FD2 128	FD2 1580	FD2 1680	FD2 1880	FD2 2080	FD2 2280					
99 15/16" [2538]	99 5/8" [2531]	99 1/16" [2516]	96" [2438]	83 7/16" [2119]	FD2 1225	FD2 1525	FD2 1625	FD2 1825	FD2 2025	FD2 2225					
107 3/16 [2722]	106 7/8" [2715]	106 5/16" [2700]	103 1/4" [2622]	90 11/16" [2303]	FD2 1227	FD2 1527	FD2 1627	FD2 1827							

Height

* Transom units

Swinging Terrace & French Doors -
2.25 Inch - **Standard Stile (>3") FD**

Size Charts

FD2 Non-Clad

Width

Height

Rough Opening				Width					
				Frame					
				Panel					
				Visible Glass					
				47 1/4" [1200]	60 15/16" [1548]	67 1/2" [1714]	75 13/16" [1926]	80 5/8" [2048]	87 13/16" [2230]
				46 1/2" [1181]	60 3/16" [1529]	66 3/4" [1695]	75 1/16" [1907]	79 7/8" [2029]	87 1/16" [2211]
				21 11/16" [551]	28 9/16" [725]	31 13/16" [808]	36" [914]	38 3/8" [975]	41 15/16" [1066]
				13 1/16" [331]	19 7/8" [505]	23 1/8" [588]	27 5/16" [694]	29 3/4" [755]	33 5/16" [846]
				TRANSOM					
16 1/2" [419]	15 3/4" [400]	13 7/8" [352]	9 11/16" [246]	*FDT2 1204	*FDT2 1504	*FDT2 1604	*FDT2 1804	*FDT2 2004	*FDT2 2204
24 3/8" [619]	23 5/8" [600]	21 3/4" [552]	17 9/16" [446]	*FDT2 1206	*FDT2 1506	*FDT2 1606	*FDT2 1806	*FDT2 2006	*FDT2 2206
32 1/4" [819]	31 1/2" [800]	29 9/16" [751]	25 3/8" [645]	*FDT2 1208	*FDT2 1508	*FDT2 1608	*FDT2 1808	*FDT2 2008	*FDT2 2208
				DOOR					
80 1/8" [2035]	79 1/2" [2020]	77" [1956]	64 13/16" [1646]	FD2 1220	FD2 1520	FD2 1620	FD2 1820	FD2 2020	FD2 2220
81 7/8" [2080]	81 5/16" [2065]	78 3/4" [2001]	66 9/16" [1691]	FD2 1221	FD2 1521	FD2 1621	FD2 1821	FD2 2021	FD2 2221
86 9/16" [2199]	86" [2184]	83 7/16" [2120]	71 4/4" [1810]	FD2 1270	FD2 1570	FD2 1670	FD2 1870	FD2 2070	FD2 2270
95 1/16" [2415]	94 1/2" [2400]	91 15/16" [2336]	79 3/4" [2026]	FD2 1224	FD2 1524	FD2 1624	FD2 1824	FD2 2024	FD2 2224
98" [2489]	97 3/8" [2474]	94 57/8" [2410]	82 11/16" [2100]	FD2 128	FD2 1580	FD2 1680	FD2 1880	FD2 2080	FD2 2280
99 5/8" [2531]	99 1/16" [2516]	96 9/16" [2452]	84 5/16" [2142]	FD2 1225	FD2 1525	FD2 1625	FD2 1825	FD2 2025	FD2 2225
106 7/8" [2715]	106 5/16" [2700]	103 3/4" [2636]	91 9/16" [2326]	FD2 1227	FD2 1527	FD2 1627	FD2 1827	FD2 2027	FD2 2227
124" [3150]	123 7/16" [3135]	120 7/8" [3071]	108 11/16" [2761]	FD2 1232	FD2 1532	FD2 1632	FD2 1832	FD2 2032	FD2 2232

* Transom units

Swinging Terrace & French Doors -
2.25 Inch - **Standard Stile (>3") FD**

Size Charts

FD3 Metal-Clad

					Width		
Rough Opening Inswing with Jamb Extension					90 3/16" [2290]	100" [2539]	107 7/8" [2740]
Rough Opening					89 1/2" [2274]	99 5/16" [2523]	107 1/4" [2724]
Frame					88 3/4" [2255]	98 9/16" [2504]	106 1/2" [2705]
Panel					28 9/16" [726]	31 7/8" [809]	34 1/2" [876]
Visible Glass					19 15/16" [506]	23 3/16" [589]	25 13/16" [656]
					TRANSOM		
16 5/8" [422]	16 5/16" [415]	15 3/4" [400]	13 7/8" [352]	9 11/16" [246]	*FDT3 2204	*FDT3 2404	*FDT3 2704
24 1/2" [622]	24 3/16" [615]	23 5/8" [600]	21 3/4" [552]	17 9/16" [446]	*FDT3 2206	*FDT3 2406	*FDT3 2706
					DOOR		
80 3/8" [2042]	80 1/8" [2035]	79 1/2" [2020]	76 7/16" [1942]	63 7/8" [1623]	FD3 2220	FD3 2420	FD3 2720
82 3/16" [2087]	81 7/8" [2080]	81 5/16" [2065]	78 1/4" [1987]	65 11/16" [1668]	FD3 2221	FD3 2421	FD3 1821
86 7/8" [2206]	86 9/16" [2199]	86" [2184]	82 15/16" [2106]	70 3/8" [1787]	FD3 2270	FD3 2470	FD3 2770
95 3/8" [2422]	95 1/16" [2415]	94 1/2" [2400]	91 7/16" [2322]	78 7/8" [2003]	FD3 2224	FD3 2424	FD3 2724
98 1/4" [2496]	98" [2489]	97 3/8" [2474]	94 5/16" [2396]	81 3/4" [2077]	FD3 2280	FD3 2480	FD3 2780
99 15/16" [2538]	99 5/8" [2531]	99 1/16" [2516]	96" [2438]	83 7/16" [2119]	FD3 2225	FD3 2425	FD3 2725
107 3/16" [2722]	106 7/8" [2715]	106 5/16" [2700]	103 1/4" [2622]	90 11/16" [2303]	FD3 2227	FD3 2427	FD3 2727

Height

* Transom units

Swinging Terrace & French Doors -
2.25 Inch - **Standard Stile (>3") FD**

Size Charts

FD3 Non-Clad

				Width		
Height	Rough Opening			89 1/2" [2274]	99 5/16" [2523]	111 15/16" [2844]
	Frame			88 3/4" [2255]	98 9/16" [2504]	111 1/4" [2825]
	Panel			28 1/2" [724]	31 3/4" [807]	36" [914]
	Visible Glass			19 13/16" [504]	23 1/86" [587]	27 5/16" [694]
				TRANSOM		
16 1/2" [419]	15 3/4" [400]	13 7/8" [352]	9 11/16" [246]	*FDT3 2204	*FDT3 2404	*FDT3 2704
24 3/8" [619]	23 5/8" [600]	21 3/4" [552]	17 9/16" [446]	*FDT3 2206	*FDT3 2406	*FDT3 2706
32 1/4" [819]	31 1/2" [800]	29 9/16" [751]	25 3/8" [645]	*FDT3 2208	*FDT3 2408	*FDT3 2708
				DOOR		
80 1/8" [2035]	79 1/2" [2020]	76 7/16" [1942]	63 7/8" [1623]	FD3 2220	FD3 2420	FD3 2720
81 7/8" [2080]	81 5/16" [2065]	78 1/4" [1987]	65 11/16" [1668]	FD3 2221	FD3 2421	FD3 2721
86 9/16" [2199]	86" [2184]	82 15/16" [2106]	70 3/8" [1787]	FD3 2270	FD3 2470	FD3 2770
95 1/16" [2415]	94 1/2" [2400]	91 7/16" [2322]	78 7/8" [2003]	FD3 2224	FD3 2424	FD3 2724
98" [2489]	97 3/8" [2474]	94 5/16" [2396]	81 3/4" [2077]	FD3 2280	FD3 2480	FD3 2780
99 5/8" [2531]	99 1/16" [2516]	96" [2438]	83 7/16" [2119]	FD3 2225	FD3 2425	FD3 2725
106 7/8" [2715]	106 5/16" [2700]	103 1/4" [2622]	90 11/16" [2303]	FD3 2227	FD3 2427	FD3 2727
124" [3150]	123 7/16" [3135]	120 7/8" [3071]	108 11/16" [2761]	FD3 2232	FD3 432	FD3 2732

* Transom units

Swinging Terrace & French Doors -
2.25 Inch - **Standard Stile (>3") FD**

Size Charts

FD4 Metal-Clad

Width

Rough Opening Inswing with Jamb Extension					91 5/16" [2320]	118 3/4" [3016]	131 13/16" [3348]	142 3/8" [3616]	158 1/8" [4016]	172 7/16" [4380]
Rough Opening					90 11/16" [2304]	118 1/8" [3000]	131 3/16" [3332]	141 3/4" [3600]	157 1/2" [4000]	171 13/16" [4364]
Frame					89 15/16" [2285]	117 3/8" [2981]	130 7/16" [3313]	141" [3581]	156 3/4" [3981]	171 1/16" [4345]
Panel					21 3/4" [552]	28 9/16" [726]	31 7/8" [809]	34 1/2" [876]	38 7/16" [976]	42" [1067]
Visible Glass					13 1/16" [332]	19 15/16" [506]	23 3/16" [589]	25 13/16" [656]	29 3/4" [756]	33 3/8" [847]
					TRANSOM					
16 5/8" [422]	16 5/16" [415]	15 3/4" [400]	13 7/8" [352]	9 11/16" [246]	*FDT4 2304	*FDT4 3004	*FDT4 3304	*FDT4 3604	*FDT4 4004	*FDT4 4304
24 1/2" [622]	24 3/16" [615]	23 5/8" [600]	21 3/4" [552]	17 9/16" [446]	*FDT4 2306	*FDT4 3006	*FDT4 3306	*FDT4 3606	*FDT4 4006	*FDT4 4306
					DOOR					
80 3/8" [2042]	80 1/8" [2035]	79 1/2" [2020]	76 7/16" [1942]	63 7/8" [1623]	FD4 2320	FD4 3020	FD4 3320	FD4 3620	FD4 4020	FD4 4320
82 3/16" [2087]	81 7/8" [2080]	81 5/16" [2065]	78 1/4" [1987]	65 11/16" [1668]	FD4 2321	FD4 3021	FD4 3321	FD4 3621	FD4 4021	FD4 4321
86 7/8" [2206]	86 9/16" [2199]	86" [2184]	82 15/16" [2106]	70 3/8" [1787]	FD4 2370	FD4 3070	FD4 3370	FD4 3670	FD4 4070	FD4 4370
95 3/8" [2422]	95 1/16" [2415]	94 1/2" [2400]	91 7/16" [2322]	78 7/8" [2003]	FD4 2324	FD4 3024	FD4 3324	FD4 3624	FD4 4024	FD4 4324
98 1/4" [2496]	98" [2489]	97 3/8" [2474]	94 5/16" [2396]	81 3/4" [2077]	FD4 2380	FD4 3080	FD4 3380	FD4 3680	FD4 4080	FD4 4380
99 15/16" [2538]	99 5/8" [2531]	99 1/16" [2516]	96" [2438]	83 7/16" [2119]	FD4 2325	FD4 3025	FD4 3325	FD4 3625	FD4 4025	FD4 4325
107 3/16 [2722]	106 7/8" [2715]	106 5/16" [2700]	103 1/4" [2622]	90 11/16" [2303]	FD4 2327	FD4 3027	FD4 3327	FD4 3627		

Height

* Transom units

Swinging Terrace & French Doors -
2.25 Inch - **Standard Stile (>3") FD**

Size Charts

FD4 Non-Clad

Width

Height

Rough Opening				Width				
				Frame				
				Panel				
				Visible Glass				
				118 1/8" [3000]	131 3/16" [3332]	148 1/8" [3762]	157 1/2" [4000]	171 13/16" [4364]
				117 3/8" [2981]	130 7/16" [3313]	147 3/8" [3743]	156 3/4" [3981]	171 1/16" [4345]
				28 1/2" [723]	31 3/4" [806]	36" [914]	38 5/16" [973]	41 15/16" [1064]
				19 13/16" [503]	23 1/16" [586]	27 5/16" [694]	29 11/16" [753]	33 1/4" [844]
				TRANSOM				
16 1/2" [419]	15 3/4" [400]	13 7/8" [352]	9 11/16" [246]	*FDT4 3004	*FDT4 3304	*FDT4 3604	*FDT4 4004	*FDT4 4304
24 3/8" [619]	23 5/8" [600]	21 3/4" [552]	17 9/16" [446]	*FDT4 3006	*FDT4 3306	*FDT4 3606	*FDT4 4006	*FDT4 4306
32 1/4" [819]	31 1/2" [800]	29 9/16" [751]	25 3/8" [645]	*FDT4 3008	*FDT4 3308	*FDT4 3608	*FDT4 4008	*FDT4 4308
				DOOR				
80 1/8" [2035]	79 1/2" [2020]	76 7/16" [1942]	63 7/8" [1623]	FD4 3020	FD4 3320	FD4 3620	FD4 4020	FD4 4320
81 7/8" [2080]	81 5/16" [2065]	78 1/4" [1987]	65 11/16" [1668]	FD4 3021	FD4 3321	FD4 3621	FD4 4021	FD4 4321
86 9/16" [2199]	86" [2184]	82 15/16" [2106]	70 3/8" [1787]	FD4 3070	FD4 3370	FD4 3670	FD4 4070	FD4 4370
95 1/16" [2415]	94 1/2" [2400]	91 7/16" [2322]	78 7/8" [2003]	FD4 3024	FD4 3324	FD4 3624	FD4 4024	FD4 4324
98" [2489]	97 3/8" [2474]	94 5/16" [2396]	81 3/4" [2077]	FD4 3080	FD4 3380	FD4 3680	FD4 4080	FD4 4380
99 5/8" [2531]	99 1/16" [2516]	96" [2438]	83 7/16" [2119]	FD4 3025	FD4 3325	FD4 3625	FD4 4025	FD4 4325
106 7/8" [2715]	106 5/16" [2700]	103 1/4" [2622]	90 11/16" [2303]	FD4 3027	FD4 3327	FD4 3627	FD4 4027	FD4 4327
124" [3150]	123 7/16" [3135]	120 7/8" [3071]	108 11/16" [2761]	FD4 3032	FD4 3332	FD4 3632	FD4 4032	FD4 4332

* Transom units

Swinging Terrace & French Doors -
2.25 Inch - **Standard Stile (>3") FD**

Size Charts

Cambertop FD2 Metal-Clad

		Width									
Height	Rough Opening Inswing with Jamb Extension					47 7/8" [1216]	61 9/16" [1564]	68 1/8" [1730]	73 3/8" [1864]	81 1/4" [2064]	88 7/16" [2246]
	Rough Opening					47 1/4" [1200]	60 15/16" [1548]	67 1/2" [1714]	72 3/4" [1848]	80 5/8" [2048]	87 13/16" [2230]
	Frame					46 1/2" [1181]	60 3/16" [1529]	66 3/4" [1695]	72" [1829]	79 7/8" [2029]	87 1/16" [2211]
	Panel					21 3/4" [552]	28 9/16" [726]	31 7/8" [809]	34 1/2" [876]	38 7/16" [976]	42" [1067]
	Visible Glass					13 1/16" [332]	19 15/16" [506]	23 3/16" [589]	25 13/16" [656]	29 3/4" [756]	33 3/8" [847]
80 3/8" [2042]	80 1/8" [2035]	79 1/2" [2020]	76 7/16" [1942]	63 3/4" [1619]	FD2 1220	FD2 1520	FD2 1620	FD2 1820	FD2 2020	FD2 2220	
82 3/16" [2087]	81 7/8" [2080]	81 5/16" [2065]	78 1/4" [1987]	65 1/2" [1664]	FD2 1221	FD2 1521	FD2 1621	FD2 1821	FD2 2021	FD2 2221	
86 7/8" [2206]	86 9/16" [2199]	86" [2184]	82 15/16" [2106]	70 3/16" [1783]	FD2 1270	FD2 1570	FD2 1670	FD2 1870	FD2 2070	FD2 2270	
95 3/8" [2422]	95 1/16" [2415]	94 1/2" [2400]	91 7/16" [2322]	78 3/4" [1999]	FD2 1224	FD2 1524	FD2 1624	FD2 1824	FD2 2024	FD2 2224	
98 1/4" [2496]	98" [2489]	97 3/8" [2474]	94 5/16" [2396]	81 3/4" [2077]	FD2 1280	FD2 1580	FD2 1680	FD2 1880	FD2 2080	FD2 2280	
99 15/16" [2538]	99 5/8" [2531]	99 1/16" [2516]	96" [2438]	83 5/16" [2115]	FD2 1225	FD2 1525	FD2 1625	FD2 1825			
107 3/16" [2722]	106 7/8" [2715]	106 5/16" [2700]	103 1/4" [2622]	90 1/2" [2299]	FD2 1227	FD2 1527	FD2 1627	FD2 1827			

Swinging Terrace & French Doors -
2.25 Inch - **Standard Stile (>3") FD**

Size Charts

Cambertop FD2 Non-Clad

				Width						
Height	Rough Opening	Frame		Panel		Visible Glass				
		Panel		Visible Glass						
		Visible Glass								
				47 1/4" [1200]	60 15/16" [1548]	67 1/2" [1714]	72 3/4" [1848]	80 5/8" [2048]	87 13/16" [2230]	
		Frame		46 1/2" [1181]	60 3/16" [1529]	66 3/4" [1695]	72" [1829]	79 7/8" [2029]	87 1/16" [2211]	
		Panel		21 3/4" [552]	28 9/16" [726]	31 7/8" [809]	34 1/2" [876]	38 7/16" [976]	42" [1067]	
		Visible Glass		13 1/16" [332]	19 15/16" [506]	23 3/16" [589]	25 13/16" [656]	29 3/4" [756]	33 3/8" [847]	
	80 1/8" [2035]	79 1/2" [2020]	76 7/16" [1942]	63 3/4" [1619]	FD2 1220	FD2 1520	FD2 1620	FD2 1820	FD2 2020	FD2 2220
	81 7/8" [2080]	81 5/16" [2065]	78 1/4" [1987]	65 1/2" [1664]	FD2 1221	FD2 1521	FD2 1621	FD2 1821	FD2 2021	FD2 2221
	86 9/16" [2199]	86" [2184]	82 15/16" [2106]	70 3/16" [1783]	FD2 1270	FD2 1570	FD2 1670	FD2 1870	FD2 2070	FD2 2270
	95 1/16" [2415]	94 1/2" [2400]	91 7/16" [2322]	78 3/4" [1999]	FD2 1224	FD2 1524	FD2 1624	FD2 1824	FD2 2024	FD2 2224
	98" [2489]	97 3/8" [2474]	94 5/16" [2396]	81 3/4" [2077]	FD2 1280	FD2 1580	FD2 1680	FD2 1880	FD2 2080	FD2 2280
	99 5/8" [2531]	99 1/16" [2516]	96" [2438]	83 5/16" [2115]	FD2 1225	FD2 1525	FD2 1625	FD2 1825		
	106 7/8" [2715]	106 5/16" [2700]	103 1/4" [2622]	90 1/2" [2299]	FD2 1227	FD2 1527	FD2 1627	FD2 1827		

Swinging Terrace & French Doors -
2.25 Inch - **Standard Stile (>3") FD**

Size Charts

Cambertop FD4 Metal-Clad

Width

		Rough Opening Inswing with Jamb Extension			91 5/16" [2320]	118 3/4" [3016]	131 13/16" [3348]	142 3/8" [3616]	158 1/8" [4016]	172 7/16" [4380]
		Rough Opening			90 11/16" [2304]	118 1/8" [3000]	131 3/16" [3332]	141 3/4" [3600]	157 1/2" [4000]	171 13/16" [4364]
		Frame			89 15/16" [2285]	117 3/8" [2981]	130 7/16" [3313]	141" [3581]	156 3/4" [3981]	171 1/16" [4345]
		Panel			21 3/4" [552]	28 9/16" [726]	31 7/8" [809]	34 1/2" [876]	38 7/16" [976]	42" [1067]
		Visible Glass			13 1/16" [332]	19 15/16" [506]	23 3/16" [589]	25 13/16" [656]	29 3/4" [756]	33 3/8" [847]
80 3/8" [2042]	80 1/8" [2035]	79 1/2" [2020]	76 7/16" [1942]	63 3/4" [1619]	FD4 2320	FD4 3020	FD4 3320	FD4 3620	FD4 4020	FD4 4320
82 3/16" [2087]	81 7/8" [2080]	81 5/16" [2065]	78 1/4" [1987]	65 1/2" [1664]	FD4 2321	FD4 3021	FD4 3321	FD4 3621	FD4 4021	FD4 4321
86 7/8" [2206]	86 9/16" [2199]	86" [2184]	82 15/16" [2106]	70 3/16" [1783]	FD4 2370	FD4 3070	FD4 3370	FD4 3670	FD4 4070	FD4 4370
95 3/8" [2422]	95 1/16" [2415]	94 1/2" [2400]	91 7/16" [2322]	78 3/4" [1999]	FD4 2324	FD4 3024	FD4 3324	FD4 3624	FD4 4024	FD4 4324
98 1/4" [2496]	98" [2489]	97 3/8" [2474]	94 5/16" [2396]	81 3/4" [2077]	FD4 2380	FD4 3080	FD4 3380	FD4 3680	FD4 4080	FD4 4380
99 15/16" [2538]	99 5/8" [2531]	99 1/16" [2516]	96" [2438]	83 5/16" [2115]	FD4 2325	FD4 3025	FD4 3325	FD4 3625		
107 3/16" [2722]	106 7/8" [2715]	106 5/16" [2700]	103 1/4" [2622]	90 1/2" [2299]	FD4 2327	FD4 3027	FD4 3327	FD4 3627		

Height

Swinging Terrace & French Doors -
2.25 Inch - **Standard Stile (>3") FD**

Size Charts

Cambertop FD4 Non-Clad

				Width						
Height	Rough Opening	Frame		90 11/16" [2304]	118 1/8" [3000]	131 3/16" [3332]	141 3/4" [3600]	157 1/2" [4000]	171 13/16" [4364]	
		Panel		89 15/16" [2285]	117 3/8" [2981]	130 7/16" [3313]	141" [3581]	156 3/4" [3981]	171 1/16" [4345]	
		Visible Glass		21 3/4" [552]	28 9/16" [726]	31 7/8" [809]	34 1/2" [876]	38 7/16" [976]	42" [1067]	
				13 1/16" [332]	19 15/16" [506]	23 3/16" [589]	25 13/16" [656]	29 3/4" [756]	33 3/8" [847]	
	80 1/8" [2035]	79 1/2" [2020]	76 7/16" [1942]	63 3/4" [1619]	FD4 2320	FD4 3020	FD4 3320	FD4 3620	FD4 4020	FD4 4320
	81 7/8" [2080]	81 5/16" [2065]	78 1/4" [1987]	65 1/2" [1664]	FD4 2321	FD4 3021	FD4 3321	FD4 3621	FD4 4021	FD4 4321
	86 9/16" [2199]	86" [2184]	82 15/16" [2106]	70 3/16" [1783]	FD4 2370	FD4 3070	FD4 3370	FD4 3670	FD4 4070	FD4 4370
	95 1/16" [2415]	94 1/2" [2400]	91 7/16" [2322]	78 3/4" [1999]	FD4 2324	FD4 3024	FD4 3324	FD4 3624	FD4 4024	FD4 4324
	98" [2489]	97 3/8" [2474]	94 5/16" [2396]	81 3/4" [2077]	FD4 2380	FD4 3080	FD4 3380	FD4 3680	FD4 4080	FD4 4380
	99 5/8" [2531]	99 1/16" [2516]	96" [2438]	83 5/16" [2115]	FD4 2325	FD4 3025	FD4 3325	FD4 3625		
	106 7/8" [2715]	106 5/16" [2700]	103 1/4" [2622]	90 1/2" [2299]	FD4 2327	FD4 30027	FD4 3327	FD4 3627		

Swinging Terrace & French Doors -
2.25 Inch - **Standard Stile (>3") FD**

Drawings

Outswing

HEAD & SILL DETAILS

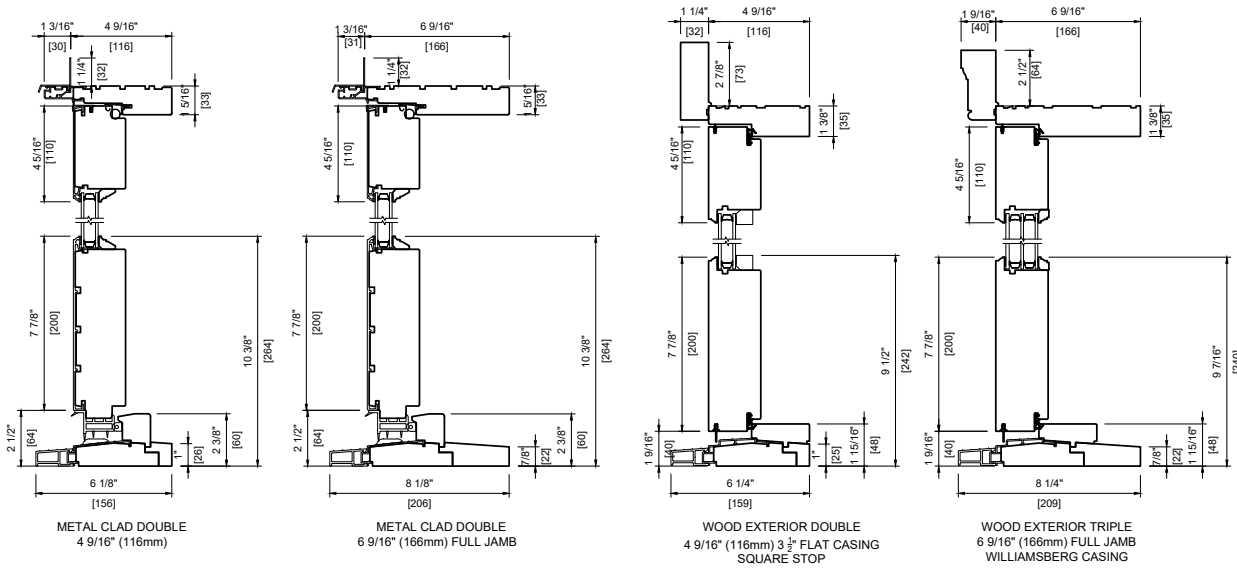

HEAD & SILL DETAILS

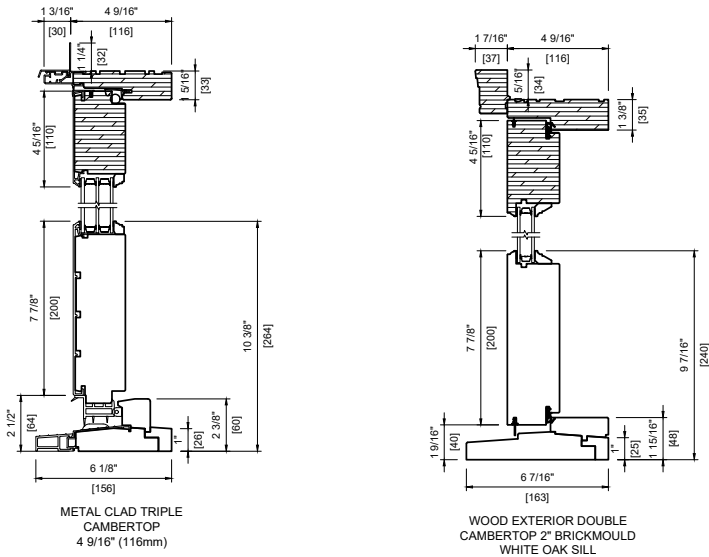

GLAZING STOP PROFILES

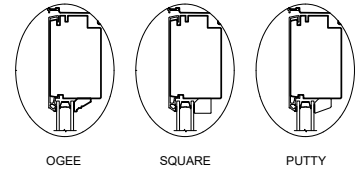

CASING

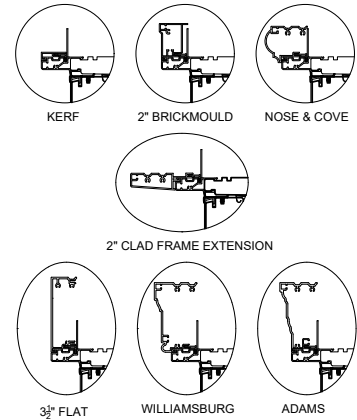

Swinging Terrace & French Doors -
2.25 Inch - **Standard Stile (>3")** FD

Drawings

Outswing (cont'd)

PLAN VIEW

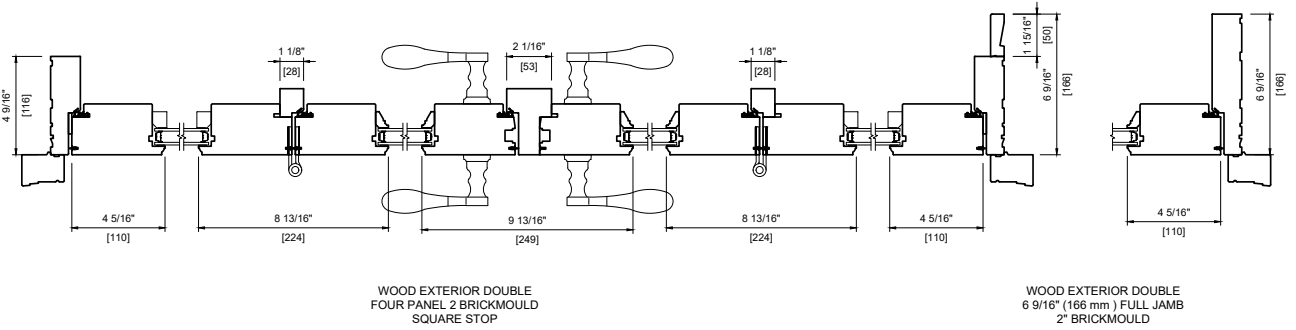
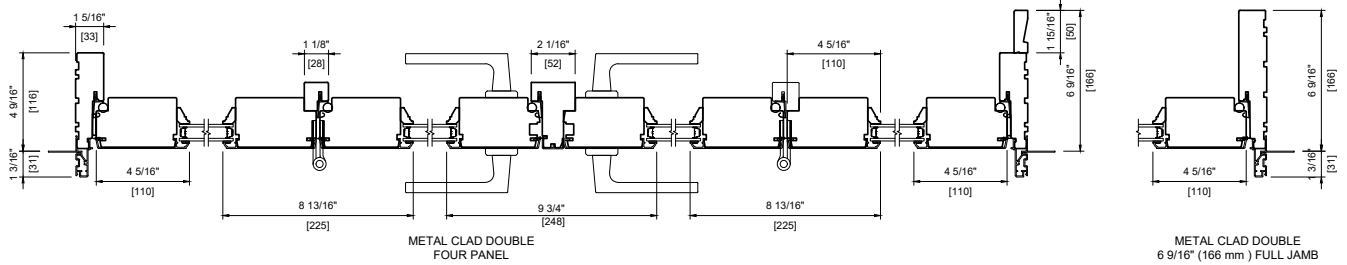

PLAN VIEW

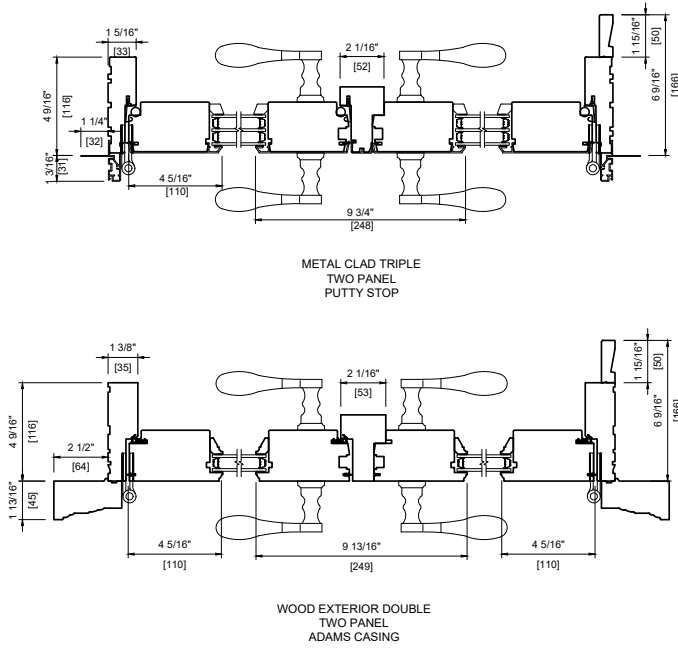

GLAZING STOP PROFILES

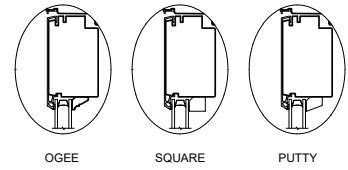

CASING

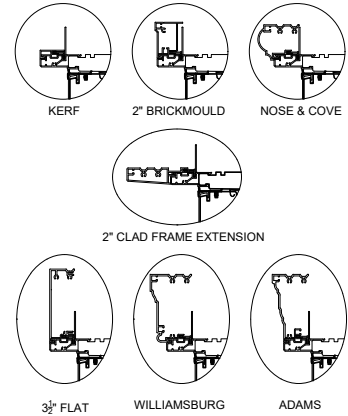

Swinging Terrace & French Doors -
2.25 Inch - **Standard Stile (>3")** FD

Drawings

Outswing (cont'd)

PLAN VIEW

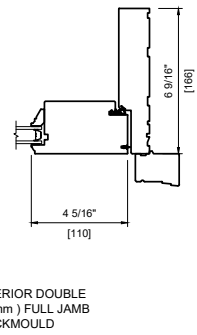
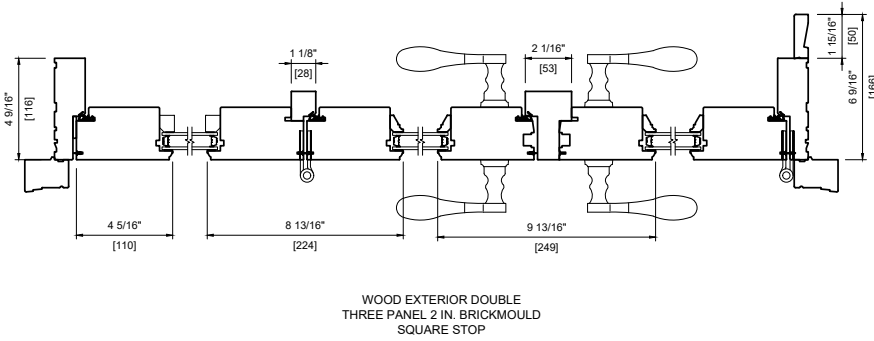
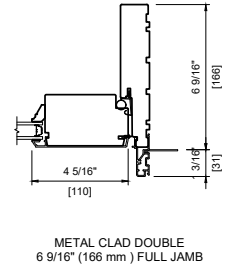
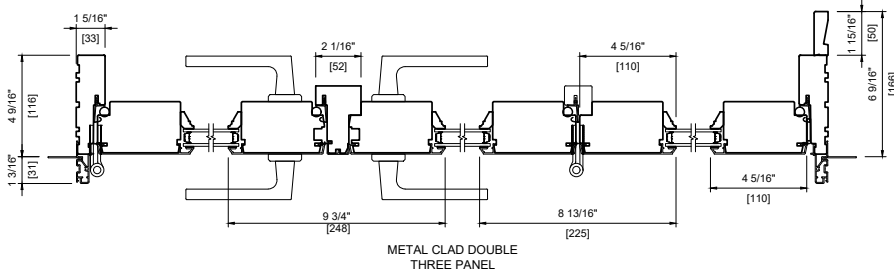

GLAZING STOP PROFILES

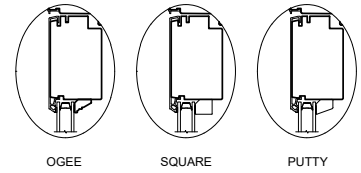

CASING

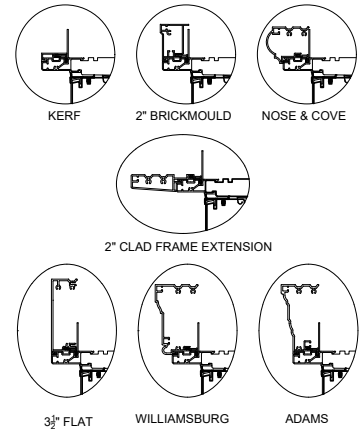

Swinging Terrace & French Doors -
2.25 Inch - **Standard Stile (>3")** FD

Drawings

Outswing Transom

HEAD & SILL

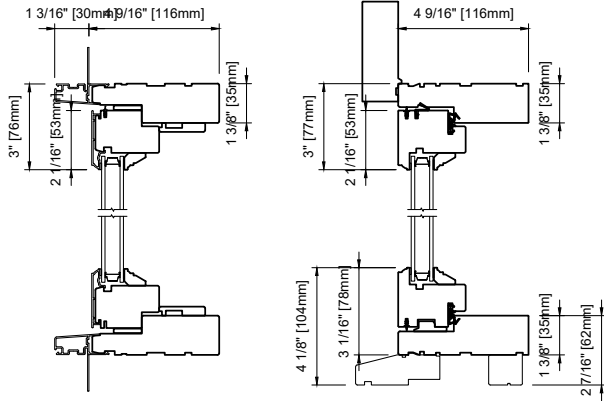

METAL CLAD DOUBLE
2 1/16" (53mm) RAILS

WOOD EXTERIOR DOUBLE
2 1/16" (53mm) RAILS

PLAN VIEW

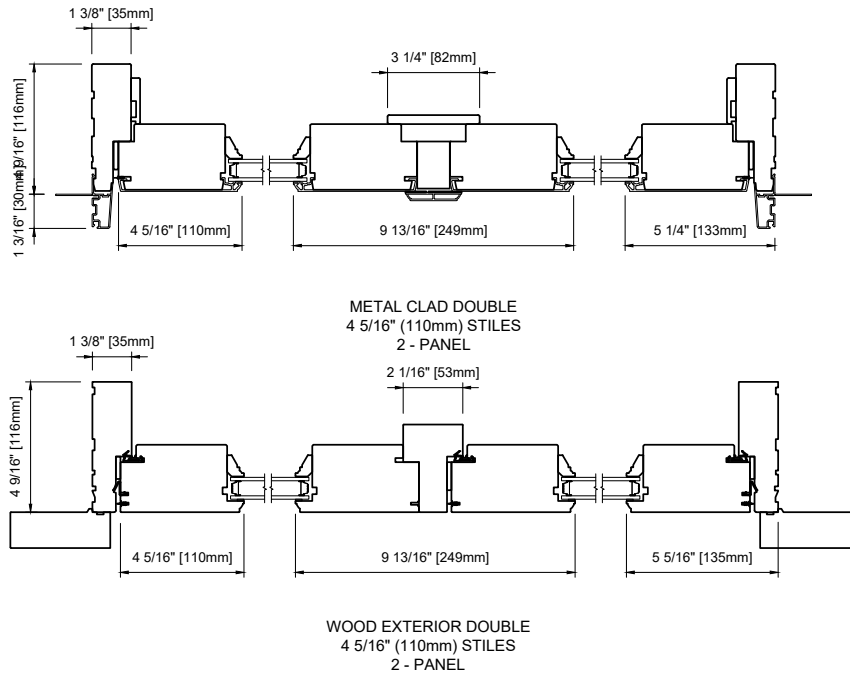

METAL CLAD DOUBLE
4 5/16" (110mm) STILES
2 - PANEL

WOOD EXTERIOR DOUBLE
4 5/16" (110mm) STILES
2 - PANEL

Swinging Terrace & French Doors -
2.25 Inch - **Standard Stile (>3")** FD

Drawings

Outswing Flat Sill, Mid Rail & Bottom Rail

HEAD & SILL DETAILS
MIDRAIL

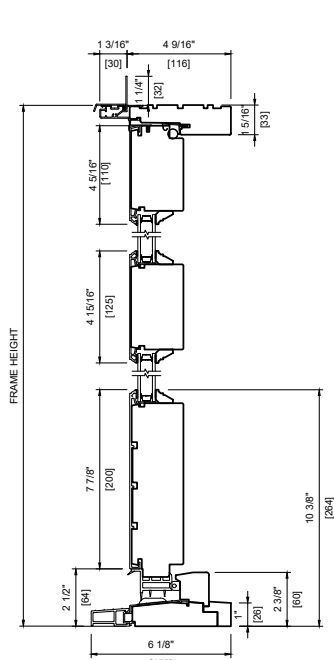

METAL CLAD with MIDRAIL
4 9/16" (116mm)

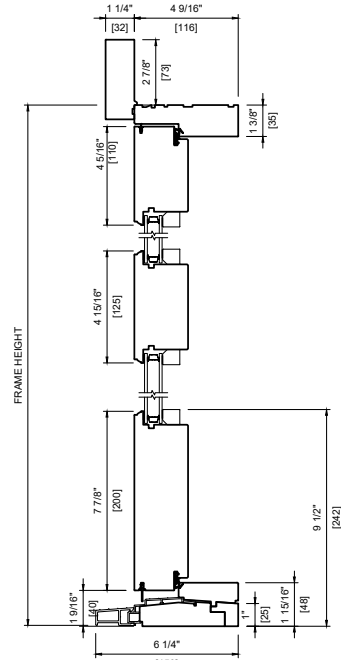

WOOD EXTERIOR with MIDRAIL
4 9/16" (116mm)

HEAD & SILL DETAILS
LOW PROFILE SILL & TALL BOTTOM RAIL

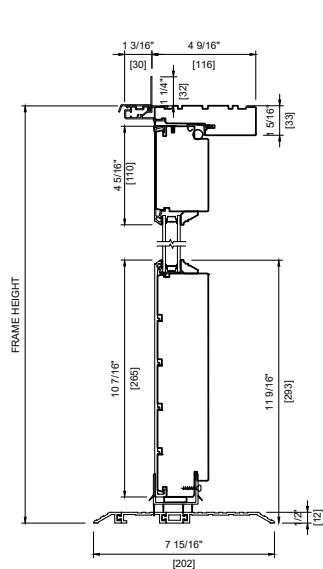

METAL CLAD with
Flat Sill and Tall Bottom Rail
4 9/16" (116mm)

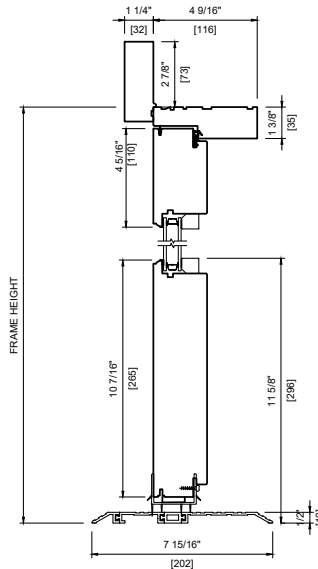

WOOD EXTERIOR with
Flat Sill and Tall Bottom Rail
4 9/16" (116mm)

