



Loewen

DOUBLE HUNG WINDOW INSTALLATION GUIDE

with Supplemental Operating Instructions

IMPORTANT NOTICES & INFORMATION

The building envelope must be correctly prepared with weather resistant barriers – that meet local and state codes. All frame and sill surfaces must be correctly prepared for air, water, and structural integrity by the builder or contractor before attempting installation. In order to meet warranty requirements, all systems are required to be installed by a certified installer.

- Read these instructions in their entirety prior to installing windows. Contact Loewen at 1.800.563.9367 for clarification.
- Loewen is not responsible for site measurements nor the structural and architectural requirements for the installation of the windows.
- Building design, construction methods, building materials and site conditions unique to your project may require methods different from these instructions.
- Choosing the appropriate method is the responsibility of you, your architect, or your construction professional.
- Confirm with sealant/foam/barrier manufacturers that all materials used are compatible with one another.
- Remove shipping blocks and related staples prior to installation.
- All drawings are shown not to scale.
- To ensure accuracy, make sure you have the latest approved shop drawings and assembly and installation guides.
- Any local, regional or national building code requirements supersede these instructions.
- Safety is top priority for Loewen. Use proper work procedures and protective equipment.

Site Preparation Advisory

This manual is intended for construction professionals with proven competency installing doors and windows for large openings. Window installations are complex and should not be attempted with simple written documentation.

Verify The Rough Opening

- Measure the rough opening and the window to determine that the size is correct. Recommended rough opening is between 3/4" (19mm) - 1" (25mm) larger than the window width and height.
- Ensure that the rough opening is plumb, level and square, and the walls in the opening are not twisted.
 - a) 1 1/2" (38 mm) solid blocking is required at the sill and sides of the opening.
 - b) Ensure proper header is in place before installation.
 - c) Make necessary corrections.

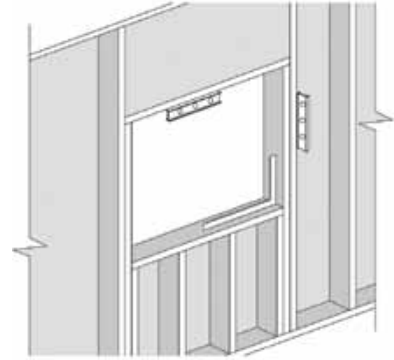

Vital Preparation Information Specifically for Double Hung

Squareness of the window along with proper shimming and adjustment of the jamb jacks is required to ensure that the frame weatherstrip makes adequate contact with the sash. This is vital to the product performance. Ensure that no daylight is visible between the sash and frame.

Jamb Jack Adjustment

Use the Jamb Jacks Screw to obtain an even gap between Sash and Frame. Using a T25 Torx screwdriver, turn the Jamb Jacks Screw clockwise to move the Jambs away from the Sash or counterclockwise to move the Jambs towards the Sash. Adjust until the gap is consistent from the top of the sash to bottom and both sides.

See page 14 for further information on Jamb Jack installation and adjustment.

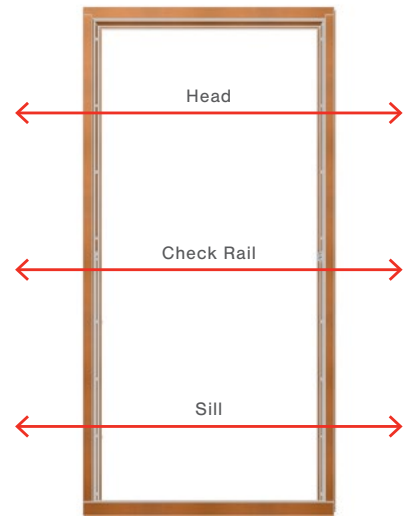

Adjust the shims at the Check Rail as necessary.

Do not remove shipping strap prior to installation of unit into rough opening.

PREPARATION INSTRUCTIONS

For detailed preparation installation instructions, see our dedicated Window Installation Guide.



Tools Required

- Laser Level
- Hammer
- Pry Bars
- Ladders
- Utility Knife
- Screw Gun Applicator
- Foam Gun
- "J" Roller
- Tape Measure
- Caulk Gun

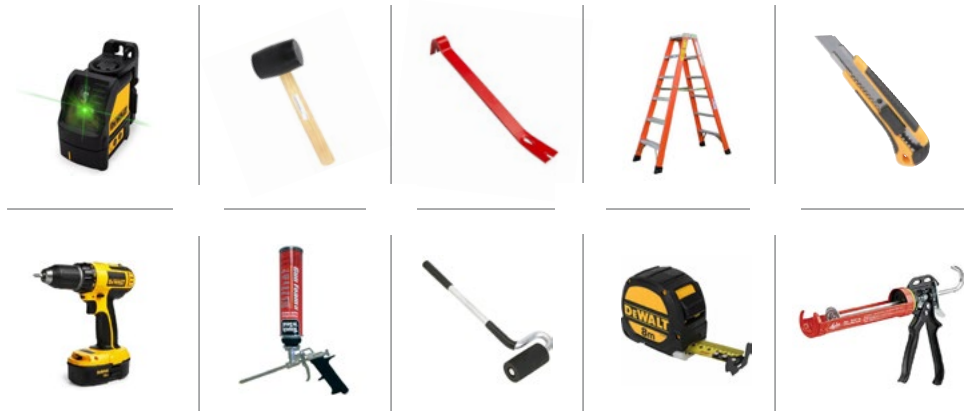

Materials Required

- High Impact Composite (not wood) shims/spacers
- 1 1/2" or 2" #8 Screws (stainless steel recommended)
- Expansion Foam - Closed Cell (low-expansion only)
- Window & Door Flashing Tape (6" recommended)
- Window & Door Sealant
- Interior Trim

INSTALLATION INSTRUCTIONS

1. Removing the Shipping Insert

Important: Sash can be both heavy and awkward to handle during removal. You may require extra assistance to prevent personal injury and/or damage to the window.

Loewen Double and Single Hung windows have a Shipping Insert which protects the unit during shipping. This Insert should be removed before installation.

1. Remove the Foam Block which supports the Shipping Insert.

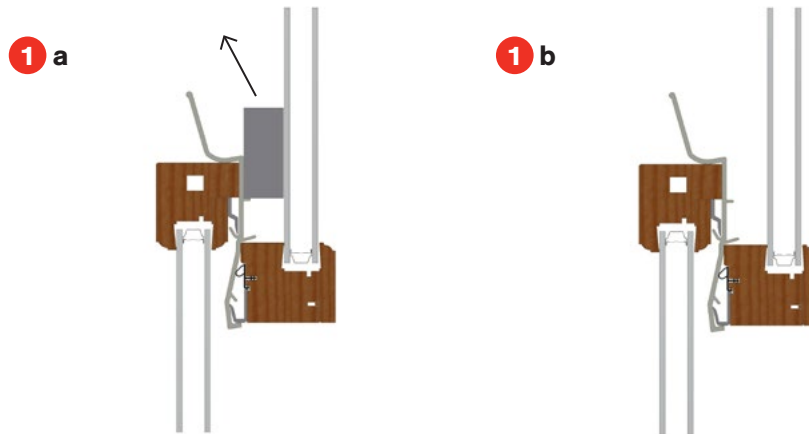

INSTALLATION INSTRUCTIONS

1. Removing the Shipping Insert (continued)

Important: Sash can be both heavy and awkward to handle during removal. You may require extra assistance to prevent personal injury and/or damage to the window.

2. Press the top of the Shipping Insert to deform it, releasing the Top Sash.

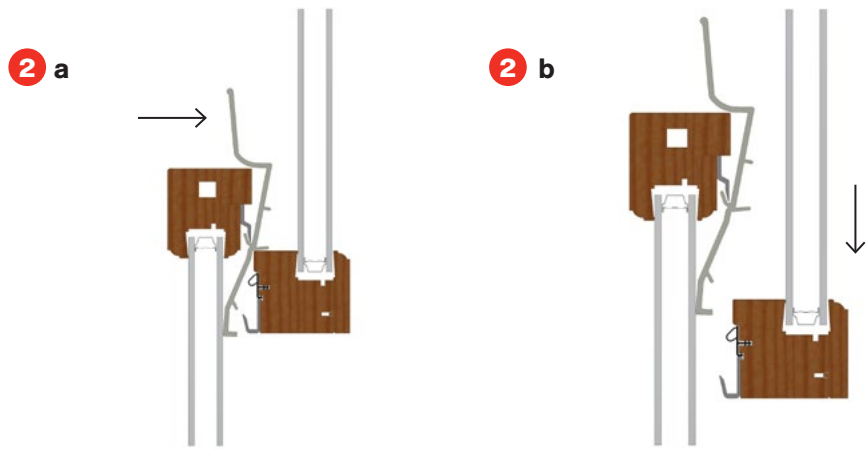

3. Remove and discard shipping clip.



INSTALLATION INSTRUCTIONS

2. Parts

2.1 Metal Clad Casing & Sill Nosing Assembly

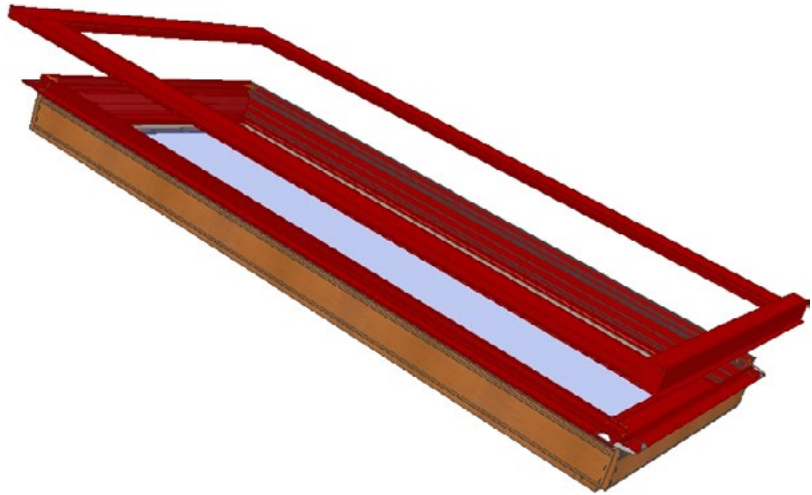

2.2 Parts Designations

1. Casing at Jamb (3 1/2" Flat Casing shown)
2. Casing at Head (3 1/2" Flat Casing shown)
3. Sill Nosing (BC Sill Nosing shown)
4. Head Casing End Cap - 3 1/2 Flat Casing Only
5. Frame Cladding
6. Accessory Retainer Clip
7. Casing Shipping Clip
8. Sill Nosing End Cap
9. Jamb - Frame
10. Sill
11. Sill Nosing Shipping Clip

Casing Options

- 2" Brickmould
- 3 1/2" Flat Casing
- Williamsburg Casing
- Nost & Cove Casing

Sill Nosing Options

- Standard Sill Nosing
- BC Sill Nosing
- Heritage Sill Nosing

Note

2" Brickmould comes with standard sill nosing. Optional casings are Williamsburg, Adams and 3 1/2" Flat Casing. These casing options automatically come with the BC Sill Nosing but are also available with the Heritage Sill Nosing.

INSTALLATION INSTRUCTIONS

2. Parts (continued)

2.3 Exploded View

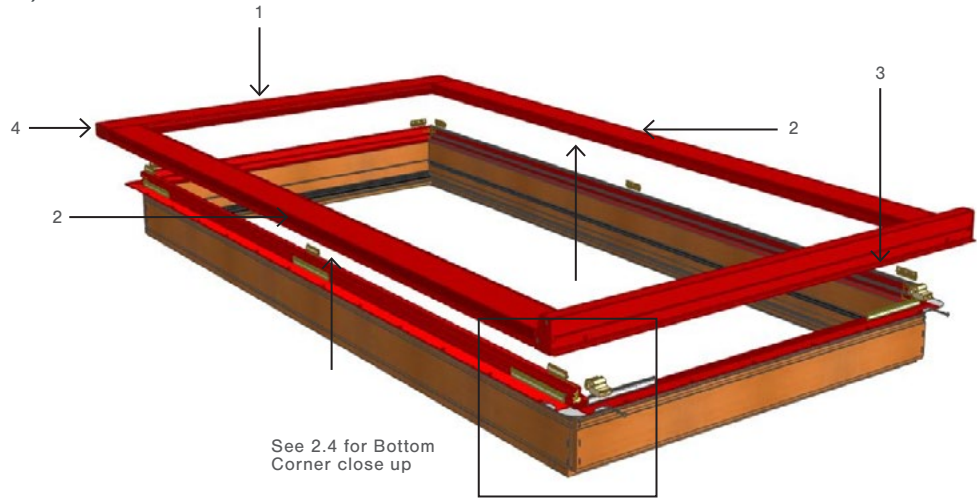

2.4 Bottom Left Corner

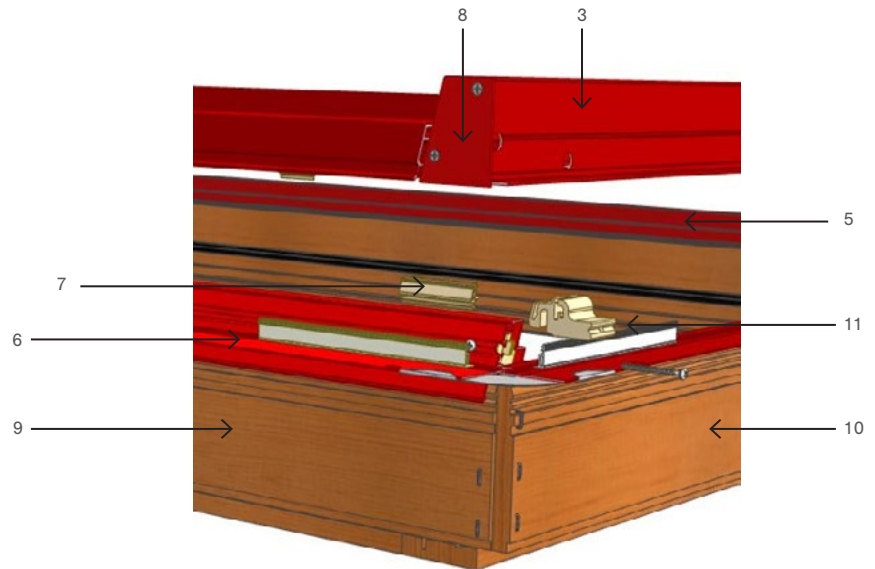

INSTALLATION INSTRUCTIONS

3. Installation & Preparation

Follow these instructions to install the site casing system to Loewen window systems

- 3.1** Remove protective packaging and dispose of as per local requirements. Gently place the unit on a clean & dry flat surface with the exterior side facing upward.

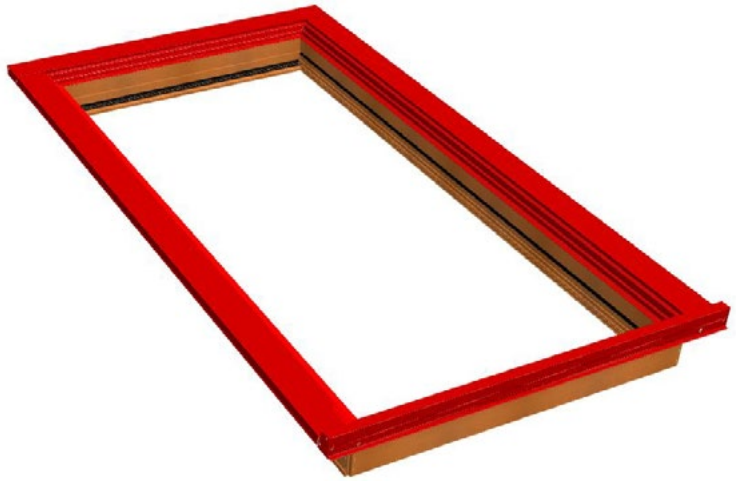

- 3.2** Optional casings will be pre-assembled and resting on the disposable casing shipping clips. The casing shipping clips keep the casings from accidentally engaging the accessory clip during shipping and handling. Remove the #6 x 1-1/2" pan head screws located on each sill nosing shipping clip (11). Keep the screws for installation of sill nosing. Separate the Casing/Sill Nosing assembly from the window by lightly lifting upwards, set casing assembly aside.

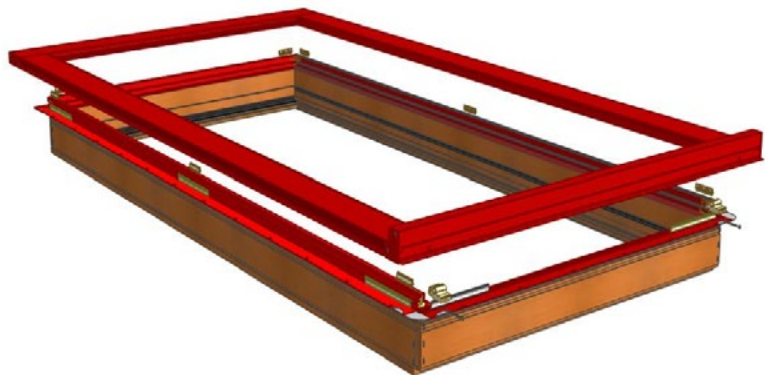

INSTALLATION INSTRUCTIONS

3. Installation & Preparation (continued)

3.3 Remove factory installed sill nosing casing shipping clip on the frame of the unit and discard. Ensure that accessory retainer clips are located 25mm (1") from each corner and then no greater than 508mm (20") apart.

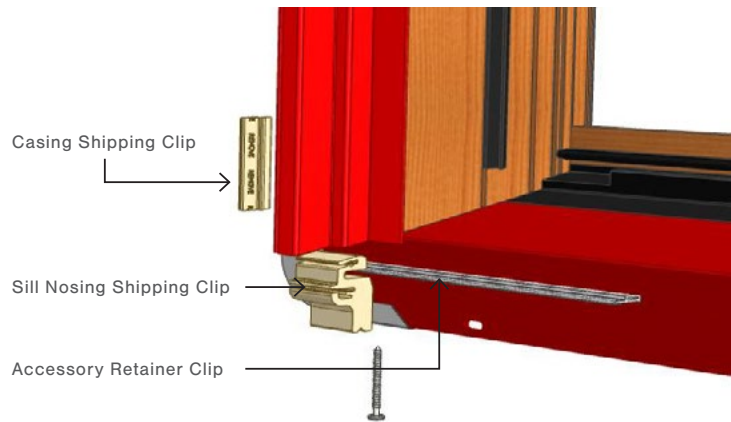

3.4 Separate Sill Nosing from the Side Casing by removing the #6 x 1-1/2" pan head screws. Two screws are located at each bottom corner.

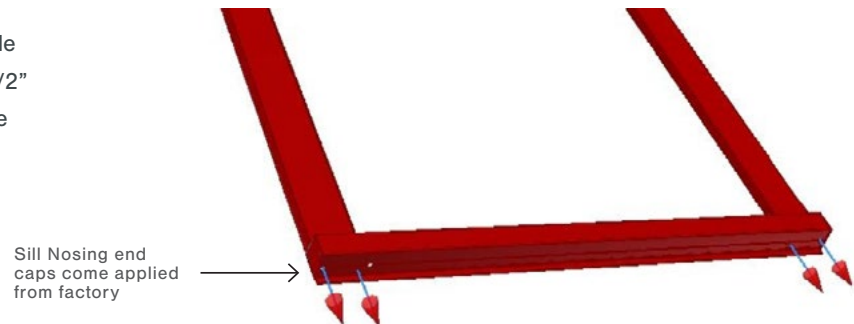

INSTALLATION INSTRUCTIONS

4. Unit & Casing System Installation

Important: Always practice safety! Wear the appropriate eye, ear and hand protection, especially when working with power tools.

- 4.1** Install and seal the window unit into wall opening as per standard Loewen installation instructions.

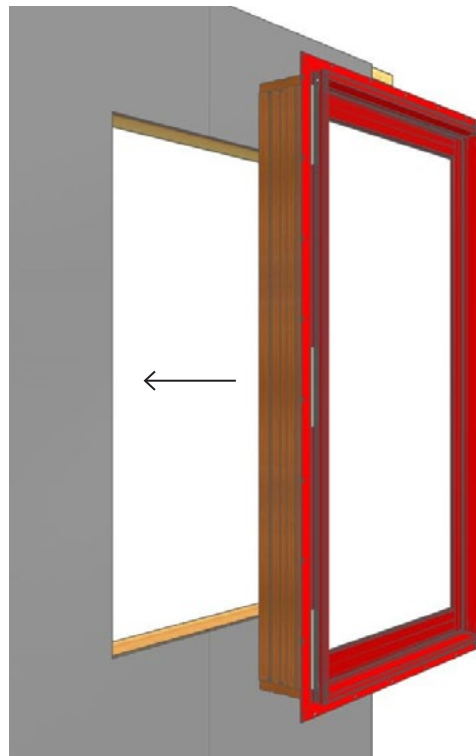

Screws on the nailing flange may need to be loosened or re-positioned while adjusting the Jamb Jacks.

INSTALLATION INSTRUCTIONS

4. Unit & Casing System Installation (continued)

4.2 Starting along the top and moving down the sides, push the casing assembly onto the frame mounted accessory retainer clips using light pressure as to not dent the casing. Insure full engagement of the casing to the frame, there should be no more than a 1/16" gap between the back of the casing and the wall surface.

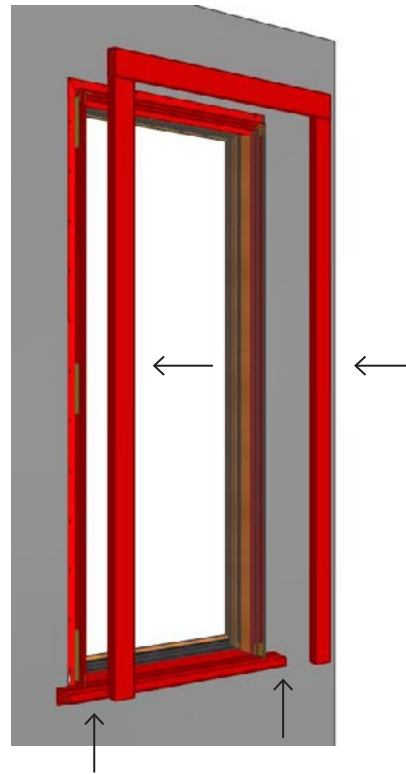

4.3 Apply continuous bead of Tremsil 600 along the sill between sill cladding and sill nosing. Apply Sill Nosing to Sill. Fill both sill corner keys through sill port hole using wood/metal joint sealant. Continue filling corner keys until sealant becomes visible around the entire perimeter of the frame cladding at the sill nosing interface.

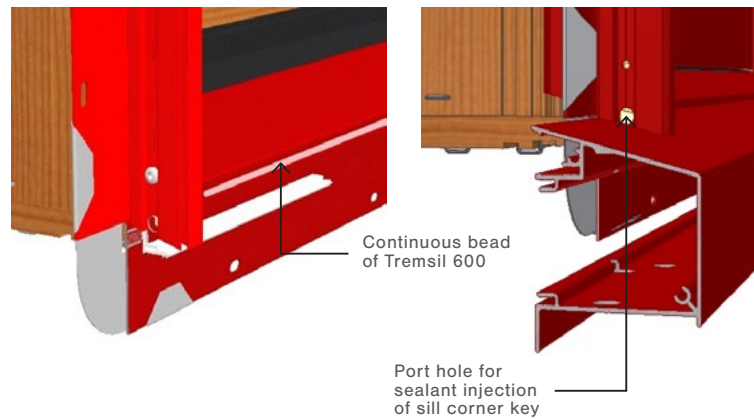

INSTALLATION INSTRUCTIONS

4. Unit & Casing System Installation (continued)

- 4.4** For Combination units only. At frame mullions, fill both frame end cavities with wood/metal joint sealant. Then follow sill nosing to sill application instructions in (3.5)

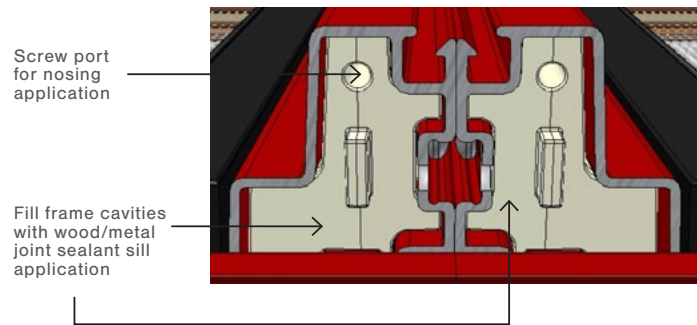

- 4.5** Secure Sill Nosing to side Frame Cladding with two #6x1-1/2" pan head screws.

Under side of sill

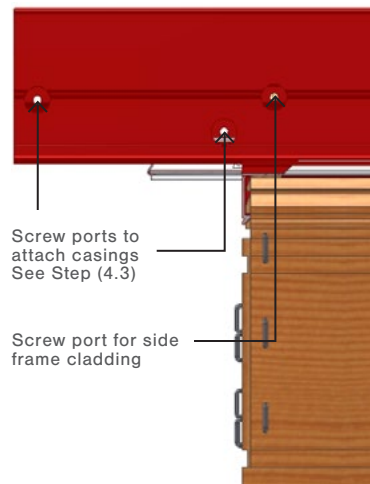

- 4.6** Attached casing with #6 x 1 1/2" pan head screws.

Side of sill

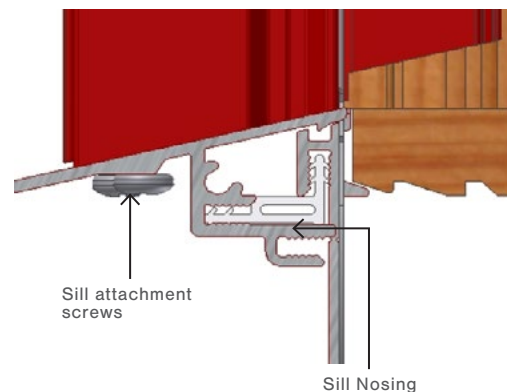

USING THE JAMB ADJUSTING SYSTEM

Installing the Jamb Jack

1. Insert the Jamb Jack Screw (parts ship with the window), into the Jamb Jack Insert. Using a T25 Torx screwdriver, drive the Jamb Jack Screw until there is a “click”.

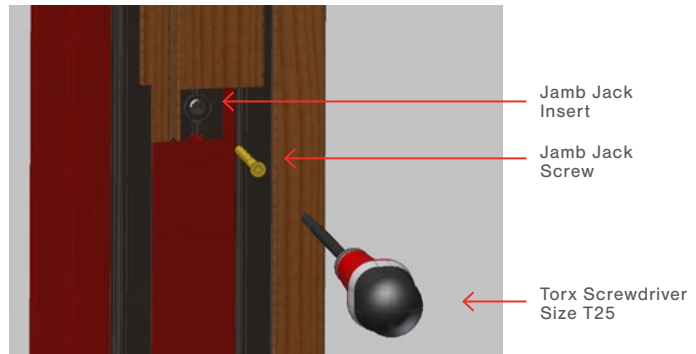

2. Measure the width at the Head, Sill and Check Rail. Use the Jamb Jacks Screw to obtain a consistent frame opening for the sash. Using a T25 Torx screwdriver, turn the Jamb Jacks Screw clockwise to move the Jambs away from the Sash or counterclockwise to move the Jambs toward the Sash. Adjust until the Head, Sill and Check Rail frame openings are all equal. Adjust the shims at the Check Rail as necessary.

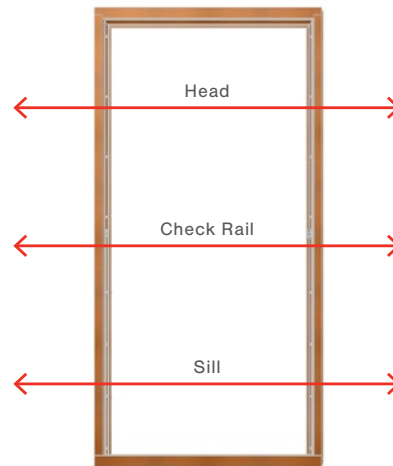

Install sash and check for even gaps between sash and frame on both sides if adjustment is required remove sash and adjust jamb jack screw to ensure an even gap between frame and sash top to bottom and on each side.

3. Reinstall the Fuzzy Pad.

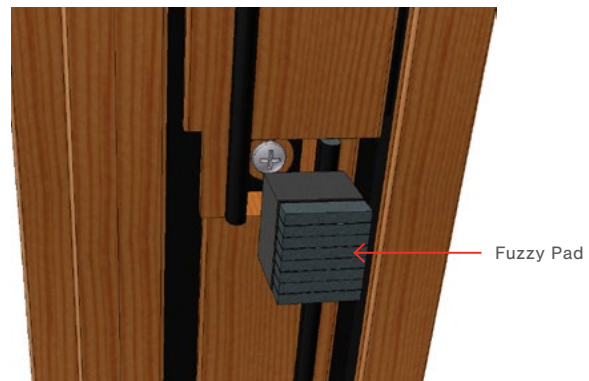

Screws on the nailing flange may need to be loosened or removed while adjusting the Jamb Jacks.

PAINTING & FINISHING THE UNIT

Be sure to follow the Loewen Finishing Instructions when finishing your window. For details, go to www.loewen.com/professionals/installation-maintenance-warranty/finishing-your-product/

When finishing the Sash, do not remove any weather-strip. If the weather-strip is removed, the window's performance may be diminished. When removing the Sash Pivots, take note that the lower screw is longer than the upper screw. Ensure that these same fasteners are replaced in their correct locations or damage may occur to the Insulating Sealed Unit.

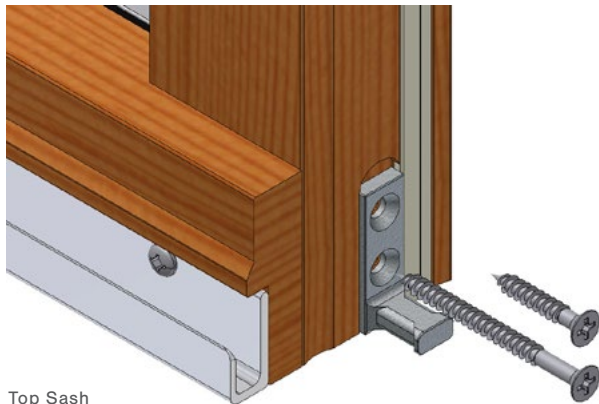

The Lock on the lower Sash and the Keeper on the upper Sash are shipped factory applied and can be removed for painting/finishing. When reapplying the Lock to lower Sash, move to locked position and position Lock onto Lock Rail aligning key on Lock to keyway on spindle.

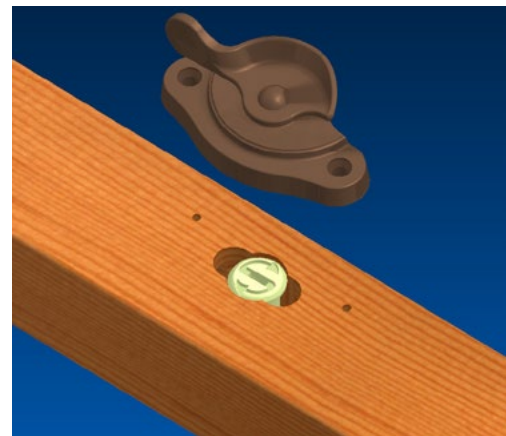
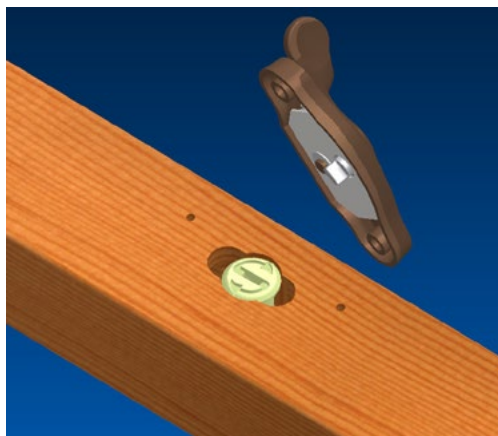

SUPPLEMENTAL OPERATING INSTRUCTIONS

Removing the Interior Sash Stops on Liberty Units

1. Use a screwdriver to remove the Interior Sash Stop screws.

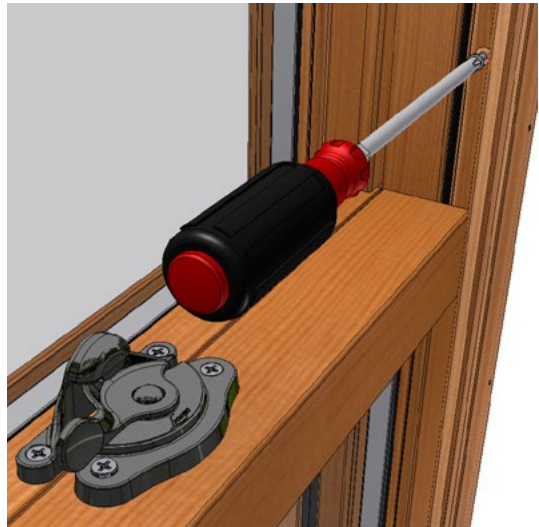

2. With the Bottom Sash Lowered, remove the Interior Sash Stop screws above the Lock Rail.

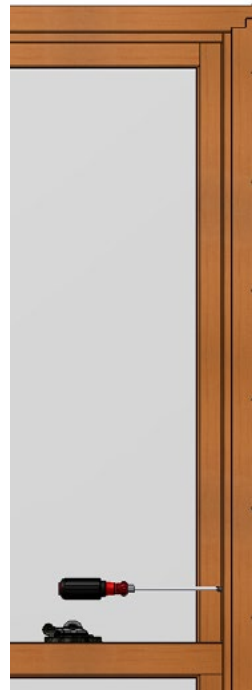

SUPPLEMENTAL OPERATING INSTRUCTIONS

Removing the Interior Sash Stops on Liberty Units (continued)

3. Raise the Bottom Sash and remove the Interior Sash Stop screws below the Sill Rail. Separate the Interior Sash Stop from the frame. The Bottom Sash can now be removed.

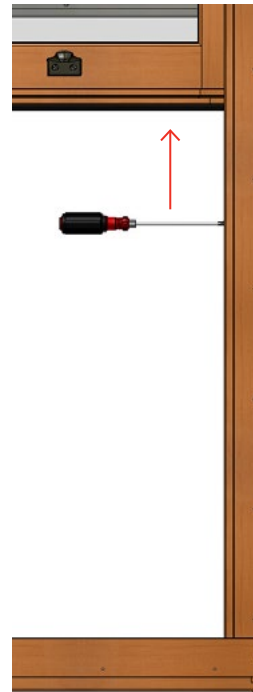

Important: Brace the bottom sash to prevent it from falling inward when removing the interior sash stop.

Note: Impact units ship with short screws holding the interior sash stop in place. When re-installing the sash stop, replace with the supplied longer screws.

SUPPLEMENTAL OPERATING INSTRUCTIONS

Tilting & Removing the Bottom Sash

Double Hung & Liberty Double Hung Units

Loewen Double and Single Hung windows have a tilt feature enabling the homeowner to wash the exterior without removing the Sash from the Frame.

1. Unlock the window and raise the Bottom Sash approximately 100 mm (4") from the Sill.



2. Rotate the Camlock an additional $\frac{1}{4}$ turn to retract the Tilt Latches from the Jamb.
Note: if lock is removed, Spindle can be rotated with a flat screwdriver to retract Tilt Latches.



Important: Sash can be both heavy and awkward to handle during removal. You may require extra assistance to prevent personal injury and/or damage to the window.

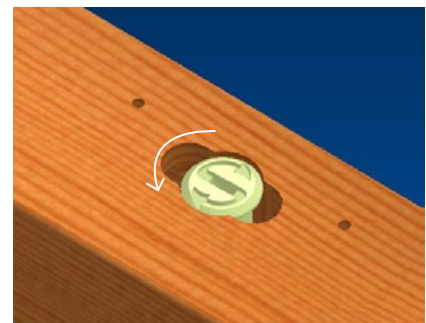

SUPPLEMENTAL OPERATING INSTRUCTIONS

Tilting & Removing the Bottom Sash (continued)

Double Hung & Liberty Double Hung Units

3. Slowly tilt the Bottom Sash inward until it is horizontal, pivoting the Sash above Sill Rail. Carefully rest the top of the Bottom Sash on a stable padded support to protect against damage to the Bottom Sash or personal injury while cleaning.

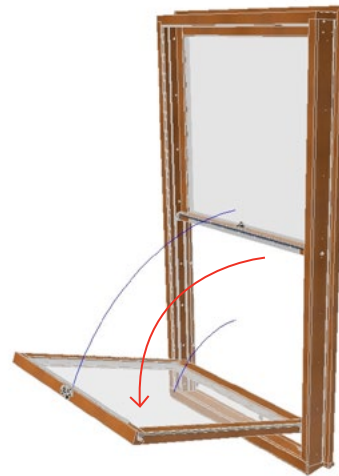

- 3b. In the case of the Liberty Impact Double Hung, a vinyl sash catch is factory applied in place of the tilt latches.

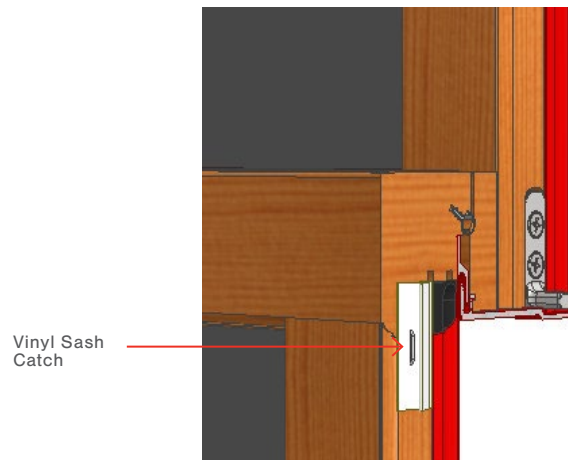

SUPPLEMENTAL OPERATING INSTRUCTIONS

Tilting & Removing the Bottom Sash (continued)

Double Hung & Liberty Double Hung Units

4. With the Bottom Sash horizontal, lift both sides of the Sash evenly for 50 mm (2") until the Sash Pivots are free from the Balance Shoe Cam. Note: Do not rack the Sash out of the Frame. Lift both Sash Pivots out of the Balance Shoes at the same time or damage to the Balance Shoe Cam may occur.

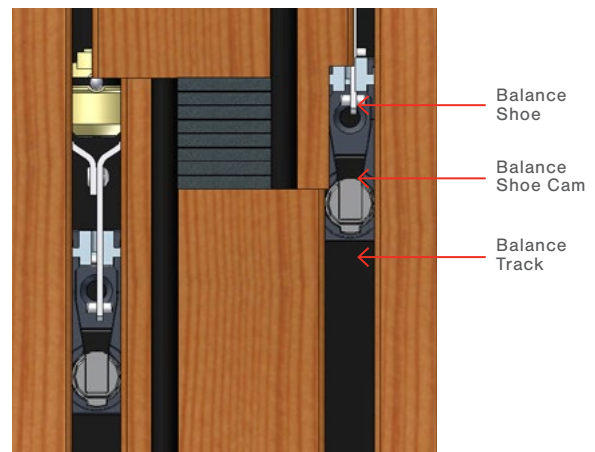
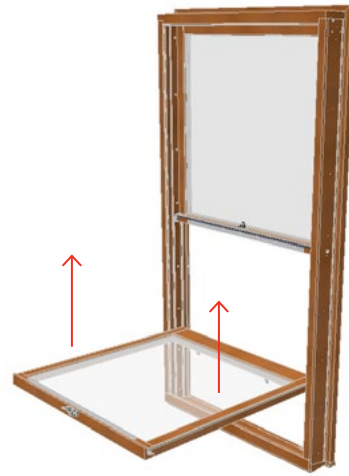

SUPPLEMENTAL OPERATING INSTRUCTIONS

Tilting & Removing the Bottom Sash (continued)

Double Hung & Liberty Double Hung Units

- Once the Sash Pivots are free from the Balance Shoes, lift one side higher than the other until the Sash Pivot is free from the Balance Track along each Jamb, being careful not to bump the edges of the Balance Track with the Sash Pivots which may damage the Jambs.

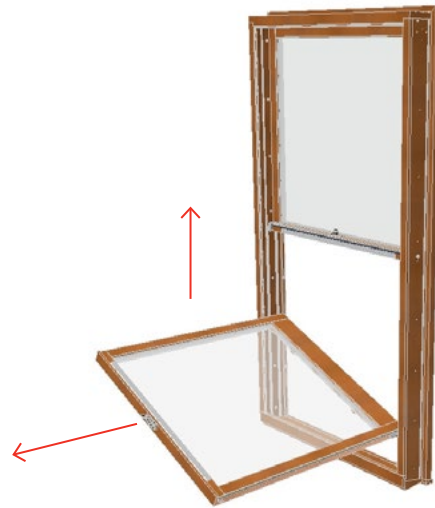

Important: Sometimes the Balance Clip may be misaligned, preventing the Sash Pivots from lifting out of the Balance Shoe. If this is the case, use a Screwdriver to reposition the Clip before attempting to remove the Sash.

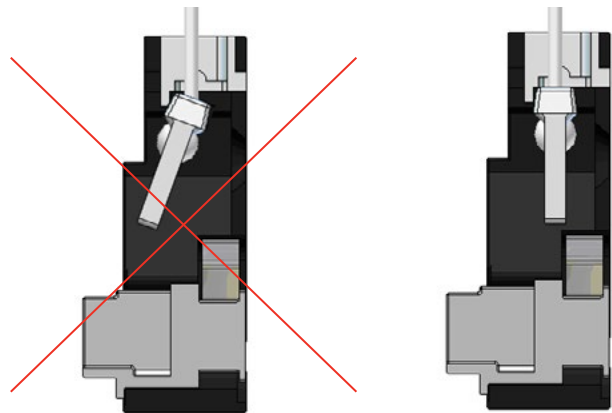

SUPPLEMENTAL OPERATING INSTRUCTIONS

Reinstalling the Bottom Sash

Double Hung & Liberty Double Hung Units

1. With the top of the Bottom Sash toward you, and the exterior side facing up, hold the Sash with one side slightly raised. Guide the Sash Pivots into the Balance Track one side at a time ensuring the pivots are 50 mm (2") above the Balance Shoes.

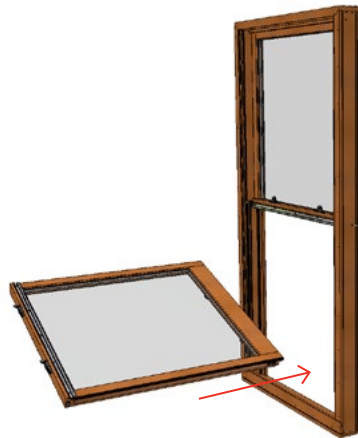

2. Move the Sash to a horizontal position and lower each side simultaneously into the Balance Shoe Cams. Ensure each Pivot is fully seated in the Balance Shoe Cam before tilting the Top Sash back into place with the Camlock rotated to retract the Tilt Latches as they pass the Jamb. Note: if lock is removed, Spindle can be rotated with a flat screwdriver to retract Tilt Latches.

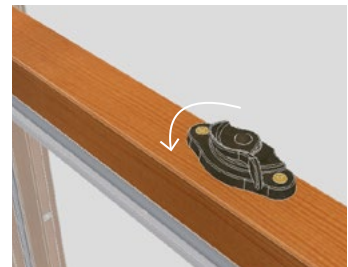
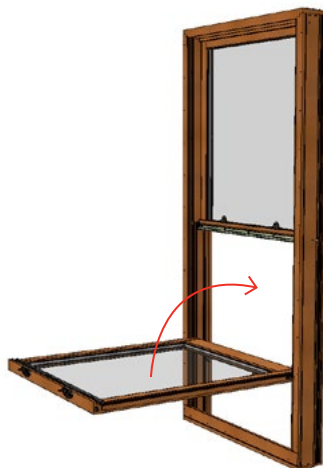

SUPPLEMENTAL OPERATING INSTRUCTIONS

Tilting & Removing the Top Sash

Double Hung & Liberty Double Hung Units

1. Lower the Top Sash approximately half way.



2. Retract the Tilt Latches on either side of the Head Rail until they release from the Jamb.



SUPPLEMENTAL OPERATING INSTRUCTIONS

Tilting & Removing the Top Sash (continued)

Double Hung & Liberty Double Hung Units

Note: The Top Sash does not tilt on a single hung window.

3. Hold the Tilt Latches in the retracted position until they clear the Jambs as you tilt the Top Sash inward until it is horizontal.

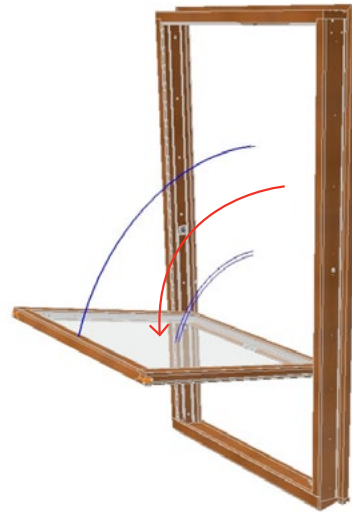

4. With the Top Sash horizontal, lift both sides of the Top Sash evenly 50 mm (2") upward until the Pivots are free from the Balance Shoe Cams. Note: Do not rack the Sash out of the Frame. Lift both pivots of out the cams at the same time or damage to the Balance Shoe Cam may occur.

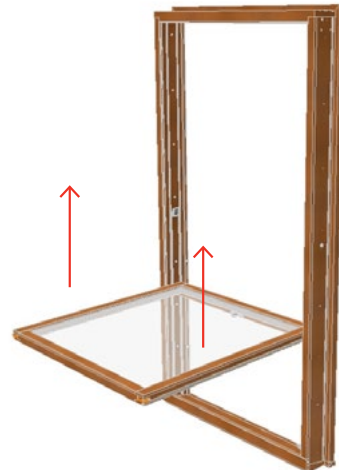

SUPPLEMENTAL OPERATING INSTRUCTIONS

Tilting & Removing the Top Sash (continued)

Double Hung & Liberty Double Hung Units

Note: The Top Sash does not tilt on a single hung window.

- Once the Pivots are free from the Balance Shoe Cams, lift one side higher than the other until the Pivot is free from the Balance Track along each Jamb, being careful not to bump the edges of the Balance Track with the Pivots which may damage the Jambs.

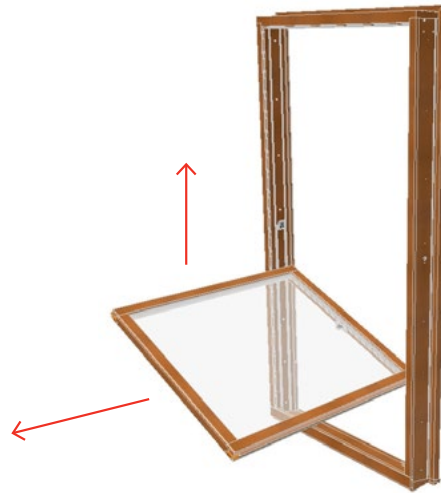

Important: Sometimes the Balance Clip may be misaligned, preventing the Sash Pivots from lifting out of the Balance Shoe. If this is the case, use a Screwdriver to reposition the Clip before attempting to remove the Sash.

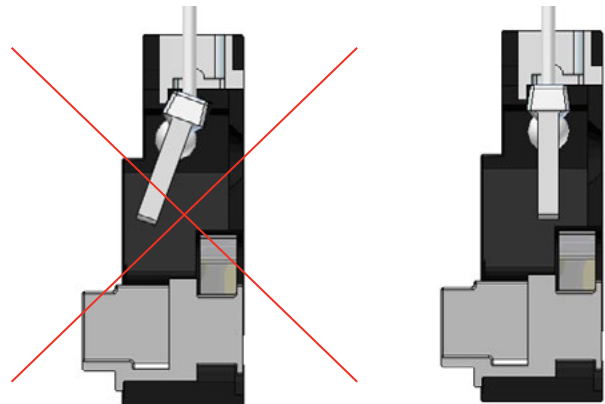

SUPPLEMENTAL OPERATING INSTRUCTIONS

Reinstalling the Top Sash

Double Hung & Liberty Double Hung Units

1. With the Top of the Sash toward you, and the exterior side facing up, hold the Sash with one side slightly raised. Guide the Sash Pivots into the Balance Track one side at a time ensuring the Sash Pivots are 50 mm (2") above the Balance Shoes.



2. Move the Sash to a horizontal position and lower each side simultaneously into the Balance Shoe Cams. Ensure each Pivot is fully seated in the Balance Shoe Cam before tilting the Top sash back into place.



3. Fully retract the Tilt Latches.

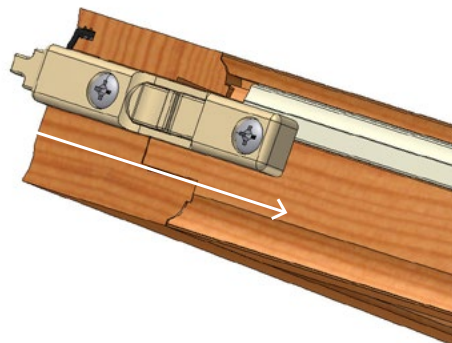

SUPPLEMENTAL OPERATING INSTRUCTIONS

Reinstalling the Top Sash (continued)

Double Hung & Liberty Double Hung Units

4. Gently tilt the Sash back into position while ensuring that the Tilt Latches are retracted so that they do not damage the Jambs.

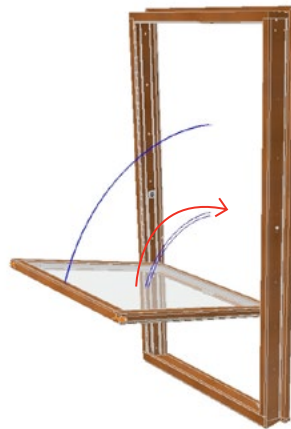

5. Once the Sash is vertical, ensure that the Tilt Latches are properly engaged along the each Jamb.



SUPPLEMENTAL OPERATING INSTRUCTIONS

Tilting & Removing the Single Hung Top Sash

Important: Brace the top sash to prevent it from falling inward when removing the sash stops.

1. Remove the Vertical Interior Sash Stops which lie along the side stiles.



2. Remove the Horizontal Interior Sash Stops which lie along the Top Stiles.



SUPPLEMENTAL OPERATING INSTRUCTIONS

Tilting & Removing the Single Hung Top Sash (continued)

3. Cut the Top Sash Retaining Clip.

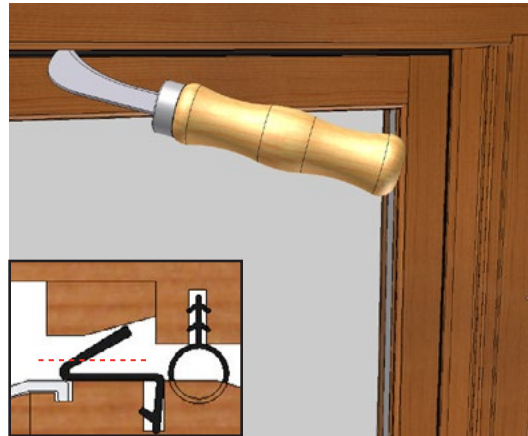

4. Tilt the Top Sash Inward and Lift the Sash out of the Balance Shoes using the Sash removal instructions described for the Double Hung.

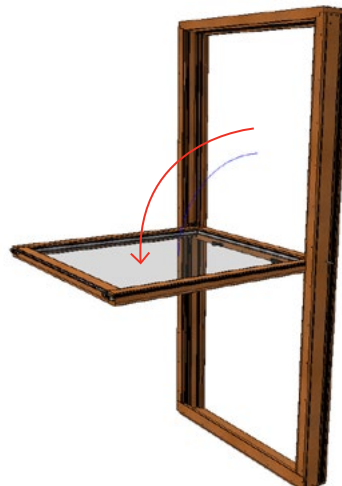

SUPPLEMENTAL OPERATING INSTRUCTIONS

Reinstalling the Single Hung Top Sash

1. Install a new Sash Retaining Clip into the Head Rail. Install a new Head Weatherstrip.

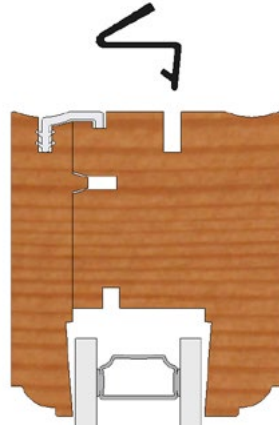

2. Insert the Sash into the Frame, ensuring the Pivots are engaged into the Balance Shoe Cams.

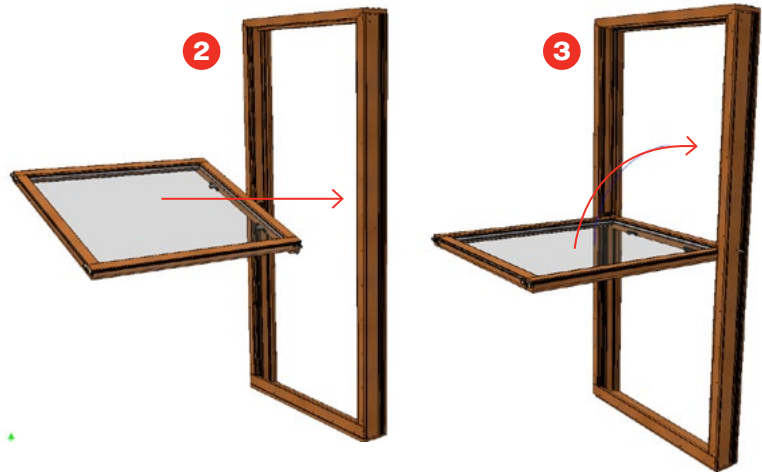

3. Gently tilt the Sash back into a vertical position.

4. Re-install the Sash Stops.

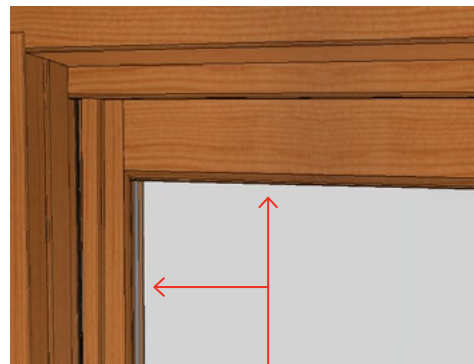

Sash Stops

SUPPLEMENTAL OPERATING INSTRUCTIONS

Setting Balance Shoe Height

Important: The Balance Shoes are under great tension when engaged. Use great caution.

Should a Balance Shoe require repositioning, complete these steps before installing the Sash.

1. Measure the Balance Shoe location on the opposing Jamb to within 3 mm (1/8") of its true position.

Opposite Jamb

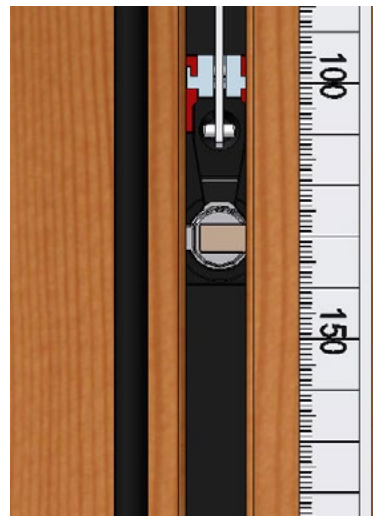

2. Temporarily mark that dimension with a pencil in along the Balance Track containing the Shoe that has slipped.

Current Jamb

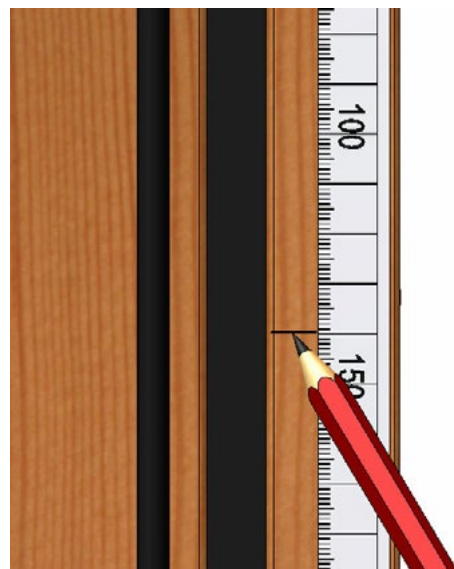

SUPPLEMENTAL OPERATING INSTRUCTIONS

Setting Balance Shoe Height (continued)

3. Using a 1/4" flathead screwdriver, rotate the Balance Shoe Cam 90° to the released position. In this position, the open face of the cam points inward. Use Caution: The Balance Shoes are under extreme tension.

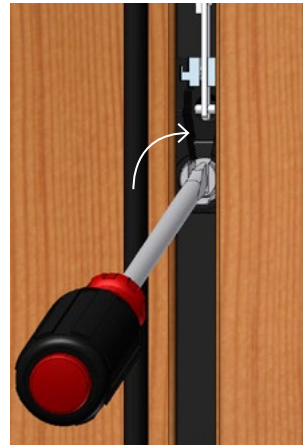

4. Holding the screwdriver firmly, slide the Balance Shoe down toward the mark made in the step above.

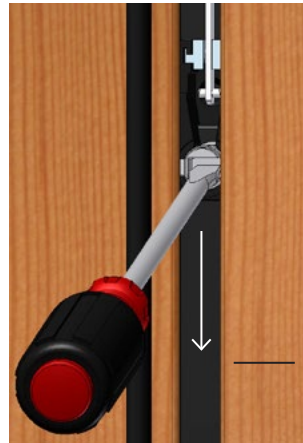

5. Lock the Balance Shoe by rotating the screwdriver counter-clockwise so that the open face of the Cam points up. Slowly remove the screwdriver from the Balance Shoe, ensuring that it is fully engaged. Verify that the Balance Shoe location is within 3 mm (1/8") of the opposite one to prevent damage when installing the Sash.

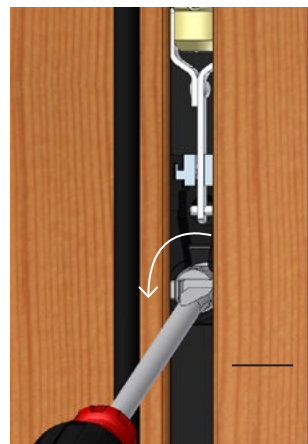

SUPPLEMENTAL OPERATING INSTRUCTIONS

Removing the Screen

1. Raise the Bottom Sash, grasp the Plunger Heads on either side of the screen and gently retract the Pins.

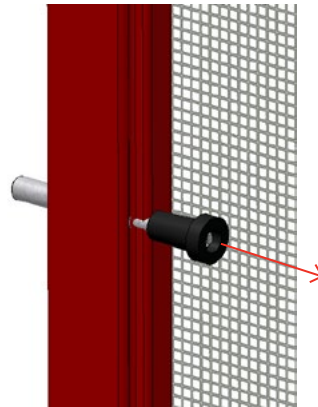

2. Slide the bottom of the Screen outward. Grasp the Screen Frame and pull down slightly.



3. Turn the Screen sideways and bring the Screen inside.

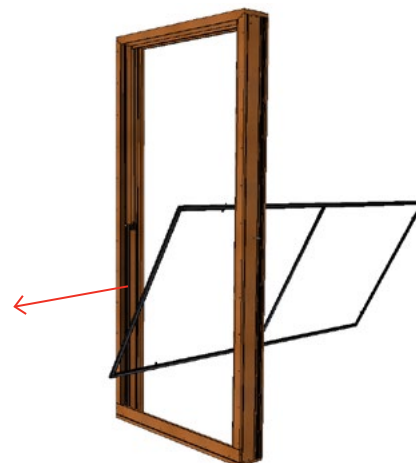

SUPPLEMENTAL OPERATING INSTRUCTIONS

Installing the Screen

1. Slide the screen sideways outward through the Frame.

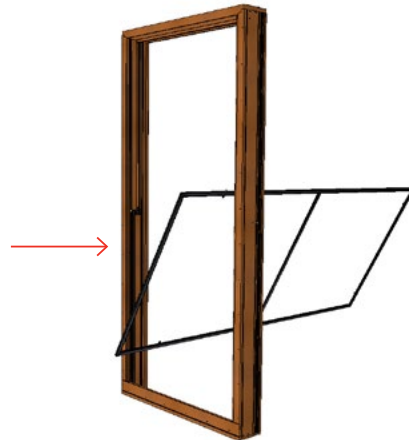

2. Turn the Screen upright and place the Top Plungers into the Grommets located in the Head.



3. Pull the Screen against the Frame leg while holding the Plunger Heads to retract the pins. Release Screen Plungers into the Grommets.



Grommet

SUPPLEMENTAL OPERATING INSTRUCTIONS

Removing the Lower Jamb Covers

1. Remove lower sash weatherstrip. Then insert a pry bar into the inside Balance Track near the Sill so that the tip rests just under the inner leg of the Lower Jamb Cover.

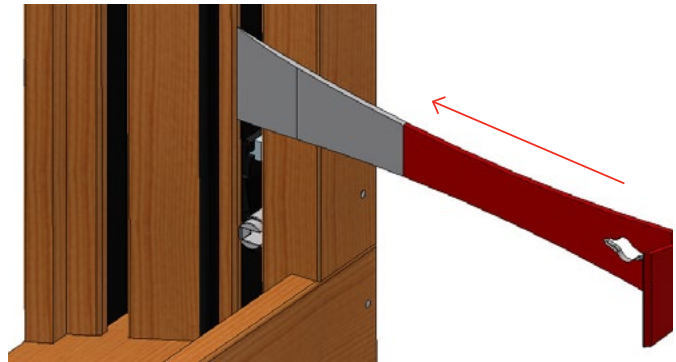

2. Pry gently upward with the pry bar (2a) until the Lower Jamb Cover begins to lift (2b). Press the tip down and under the Lower Jamb Cover, bending the Jamb Liner (2c) and pry upward until the Lower Jamb Cover is removed (2d).

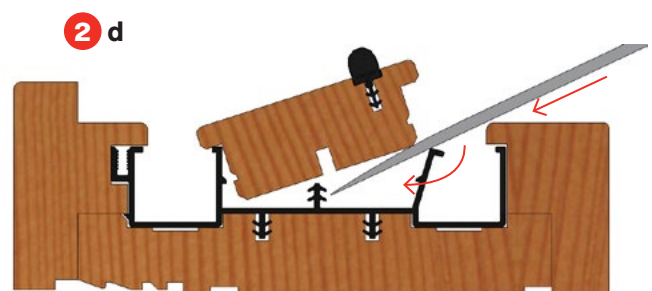
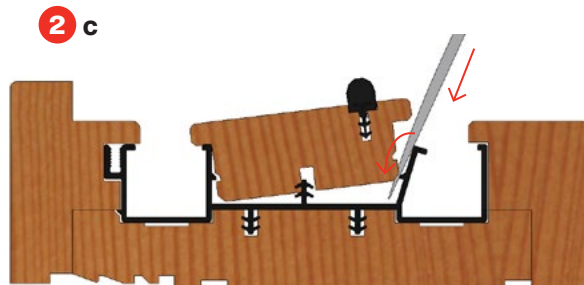
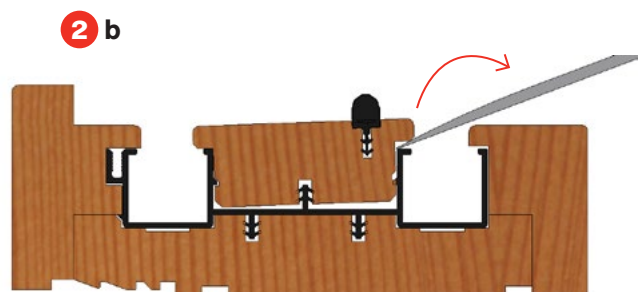
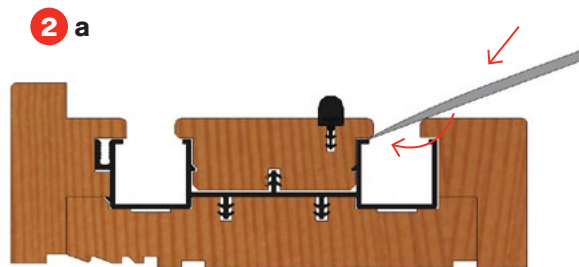

SUPPLEMENTAL OPERATING INSTRUCTIONS

Removing the Lower Jamb Covers (continued)

3. Slide the pry bar upward along the Lower Jamb Cover, repeating step 2 until the Lower Jamb Cover is completely free from the Jamb.

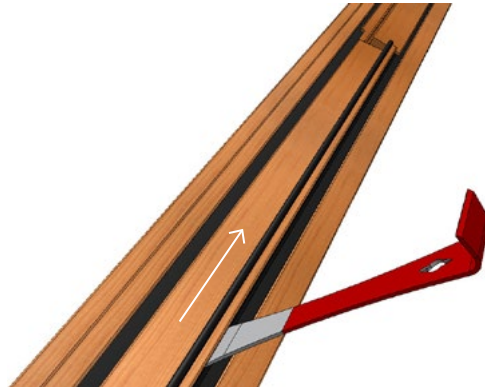

Removing the Upper Jamb Covers

1. After removing the Lower Jamb Cover, slide a flat screwdriver tip underneath the bottom end of the Upper Jamb Cover. Gently pry the Cover up.

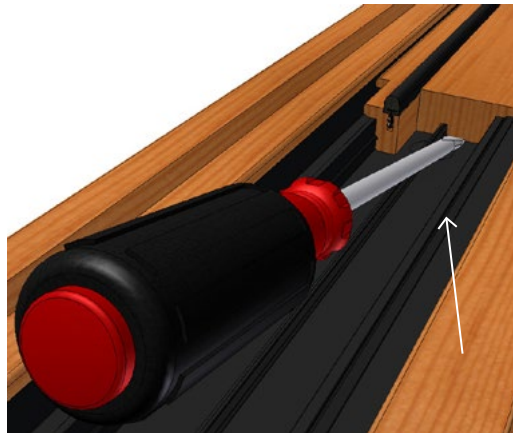

2. Continue sliding the screwdriver under the Upper Jamb Cover, prying as you go until you have completely removed the Upper Jamb Cover.

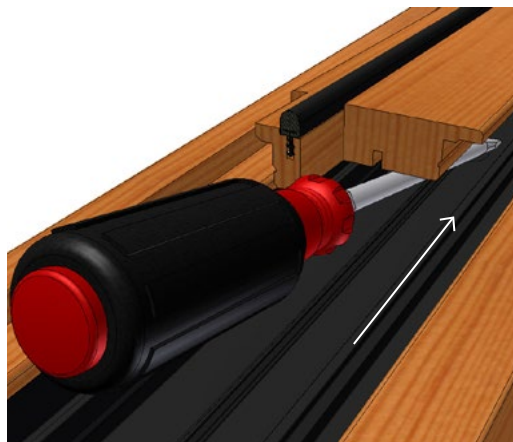

SUPPLEMENTAL OPERATING INSTRUCTIONS

Replacing Balance Shoes and Adjusting Hybrid Balances

Important: Balance components are under extreme tension. Use care when operating.

Disconnecting Block & Tackle Balances from the Balance Shoes

1. Insert the Balance Tool into the Block-and-Tackle Balance Clip.



2. Ensure that the Balance Tool fully engages the Block-and-Tackle Balance Clip.

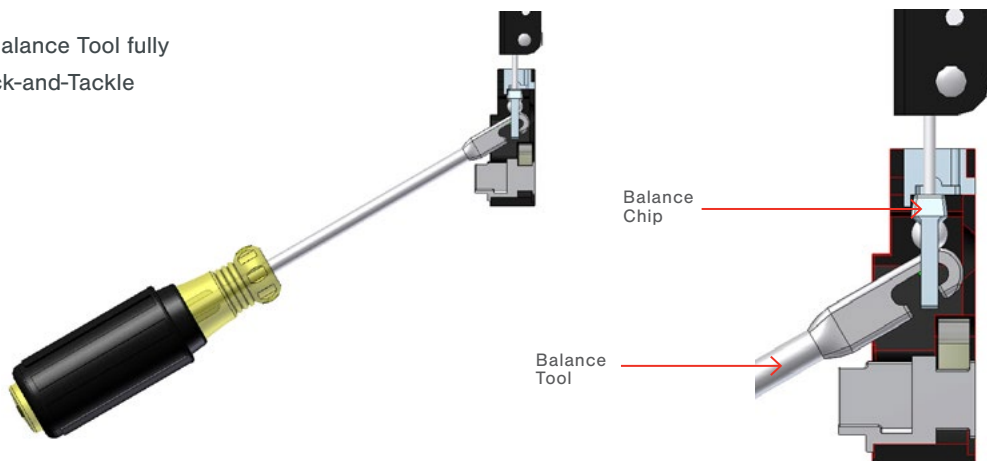

SUPPLEMENTAL OPERATING INSTRUCTIONS

Replacing Balance Shoes and Adjusting Hybrid Balances (continued)

3. With a smooth motion, pull the Clip down and out of the Balance Shoe.

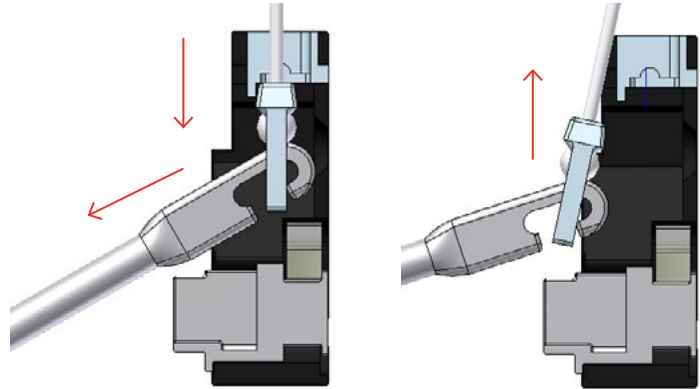

Disconnecting Hybrid Balances from the Balance Shoes

4. Hook the Balance Tool onto the Hybrid Balance Foot.



5. Ensure that the Balance Tool fully engages the Hybrid Balance Foot.

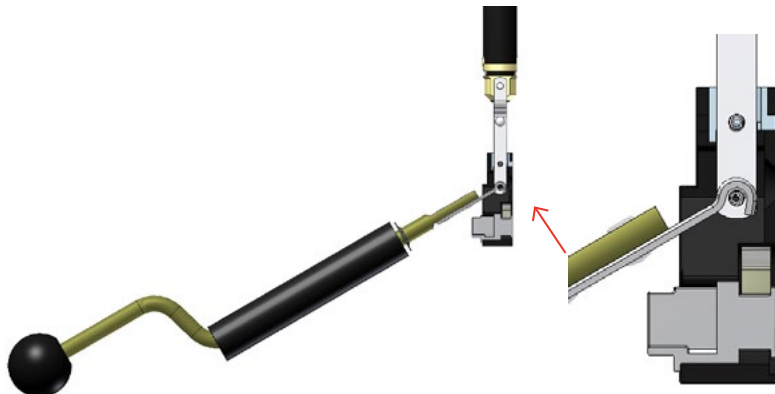

SUPPLEMENTAL OPERATING INSTRUCTIONS

Replacing Balance Shoes and Adjusting Hybrid Balances (continued)

6. With a smooth motion, pull the Foot out of the Balance Shoe.

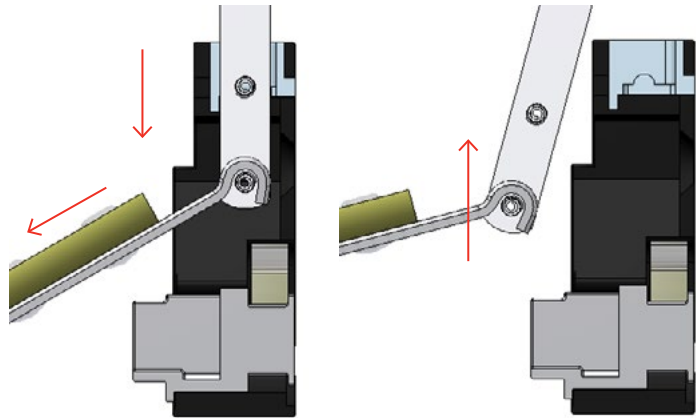

Adjusting Hybrid Balances

The weight range of some Hybrid Balances can be adjusted 3-4 lbs

7. With the Hybrid Balance disconnected from the Balance Shoe, rotate the Foot to adjust the Balance Strength.
- (A) Turn counter-clockwise to increase the lifting force (maximum four turns).
 - (B) Turn clockwise to reduce the lifting force (maximum four turns).

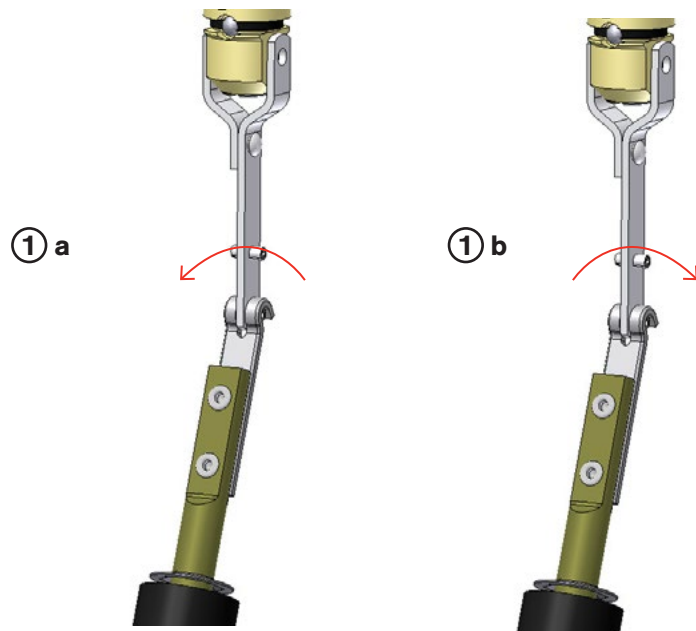

Information subject to change without notice.

Distributed by Loewen Inc. in the USA and C.P. Loewen Enterprises Ltd. in Canada and internationally. Trade Marks owned by C.P. Loewen Enterprises Ltd. Used under license.
© C.P. Loewen Enterprises Ltd. All rights reserved.

P3176A_0421

The Loewen logo is presented in a white, elegant script font, centered within a solid red rectangular background.

LOEWEN.COM